

# NEC



## XEN IPK PROGRAMMING MANUAL

**NEC Business Solutions Ltd**

Doc. No.: 8194

Release 2.0

December 2004

THIS PAGE INTENTIONALLY LEFT BLANK

# Table of Contents

## Chapter 1 Multiline Terminal Programming

<b>Section 1</b>	General Information .....	1 - 1
<b>Section 2</b>	Programming the System.....	1 - 1
<b>Section 3</b>	System Data List.....	1 - 10
<b>Section 4</b>	Programming System Data .....	1 - 29
1-1-00	Pause Time Selection.....	1 - 31
1-1-01	DP Interdigit Time Selection .....	1 - 32
1-1-02	Hookflash Time Selection .....	1 - 33
1-1-03	Hold Recall Timer Selection (Non Exclusive Hold).....	1 - 34
1-1-04	Automatic Redial Time Selection.....	1 - 36
1-1-05	Start Timer Selection .....	1 - 37
1-1-06	CO/PBX Incoming Ringing Alarm Time Selection .....	1 - 39
1-1-07	Tie Line Delay Ringing Timer Selection.....	1 - 41
1-1-09	Manual Pause Selection .....	1 - 43
1-1-11	System Transfer/Camp-On Selection .....	1 - 44
1-1-12	Station Transfer/Camp-On Recall Timer Selection.....	1 - 45
1-1-13	CO Transfer Ring Pattern Selection .....	1 - 47
1-1-14	CO Transfer Ring Tone Selection.....	1 - 49
1-1-18	System Speed Dial Restriction by Tenant .....	1 - 50
1-1-19	Line Selection for Automatic Outgoing Calls .....	1 - 53
1-1-20	DID Digit Length Selection.....	1 - 54
1-1-21	DID Digit Conversion Assignment .....	1 - 55
1-1-22	DID Digit Conversion Table & DNIS Assignment .....	1 - 56
1-1-23	DID Forward Station Number for Busy Station or Undefined Digit .....	1 - 58
1-1-24	PBX/CTX Access Code Assignment I .....	1 - 60
1-1-25	PBX/CTX Access Code Assignment II .....	1 - 61
1-1-27	Automatic Day/Night Mode Switching Time Assignment.....	1 - 62
1-1-28	Distinctive Ringing by Telephone or CO Selection .....	1 - 64
1-1-29	Private Line Assignment .....	1 - 65
1-1-30	Route Advance Block Assignment.....	1 - 66
1-1-32	Automatic Day/Night Mode by Day of Week Selection .....	1 - 68
1-1-33	Speed Dial Number/Name Display Selection .....	1 - 70
1-1-34	Tie Line First Ring Pattern Selection .....	1 - 71
1-1-35	Speed Dial Buffer Allocation .....	1 - 73
1-1-37	Trunk Queuing Timeout Selection .....	1 - 74
1-1-46	Access Code (1-Digit) Assignment .....	1 - 76
1-1-47	Access Code (2-Digit) Assignment .....	1 - 81
1-1-48	Access Code (3-Digit) Assignment .....	1 - 82
1-1-49	Networking Trunk Group/Route Advance Assignment .....	1 - 84

<b>1-1-50</b>	CO/PBX Outgoing Digit Add Assignment.....	1 - 85
<b>1-1-51</b>	CO Line Ringing Pattern Selection.....	1 - 87
<b>1-1-52</b>	PBX Line Ringing Pattern Selection.....	1 - 89
<b>1-1-53</b>	Tie Line Delay Ring Pattern Selection.....	1 - 91
<b>1-1-54</b>	Automated Attendant Transfer Ring Pattern .....	1 - 93
<b>1-1-55</b>	DID Line Ringing Pattern Selection .....	1 - 95
<b>1-1-57</b>	CO/PBX Prepause Timer Selection .....	1 - 96
<b>1-1-59</b>	Synchronous Ringing Selection .....	1 - 97
<b>1-1-60</b>	8-Digit Matching Table Assignment.....	1 - 98
<b>1-1-61</b>	8-Digit Matching Table to Class Assignment.....	1 - 100
<b>1-1-62</b>	System Speed Dial Override by Class Selection .....	1 - 102
<b>1-1-63</b>	Hold Recall Time Selection (Exclusive).....	1 - 103
<b>1-1-64</b>	Attendant Add-On Console Transfer/Camp-On Recall Timer Selection .....	1 - 105
<b>1-1-65</b>	Code Restriction Class Allow/Deny Selection .....	1 - 106
<b>1-1-66</b>	8-Digit Matching Table to Normal Dial Assignment.....	1 - 107
<b>1-1-67</b>	OCC Table Assignment.....	1 - 108
<b>1-1-68</b>	8-Digit Matching Table to OCC Table Assignment.....	1 - 109
<b>1-1-69</b>	Tie Line Code Restriction Assignment .....	1 - 110
<b>1-1-70</b>	Code Restriction Class Assignment when Lockout is Set.....	1 - 111
<b>1-1-71</b>	First Delay Announcement Start Time Selection.....	1 - 112
<b>1-1-72</b>	First Delay Announcement Repeat Selection.....	1 - 113
<b>1-1-73</b>	First to Second Delay Announcement Interval Time Selection.....	1 - 114
<b>1-1-74</b>	Second Delay Announcement Repeat Selection .....	1 - 115
<b>1-1-75</b>	Second Delay Announcement Repeat Interval Time Selection.....	1 - 116
<b>1-1-76</b>	Barge-In Alert Tone Assignment .....	1 - 117
<b>1-1-77</b>	Delayed Ringing Timer Assignment (CO) .....	1 - 118
<b>1-1-78</b>	Caller ID Display Assignment for System Mode.....	1 - 119
<b>1-1-79</b>	BGM Port Assignment.....	1 - 120
<b>1-1-80</b>	ISDN DTMF Duration/Interdigit Time Selection.....	1 - 121
<b>1-1-81</b>	ISDN Dial Interval Timer.....	1 - 122
<b>1-1-82</b>	Code Restriction Bypass Table .....	1 - 124
<b>1-1-85</b>	ISDN Stimulus Method Selection .....	1 - 125
<b>1-1-86</b>	Call Monitoring Alert Assignment .....	1 - 126
<b>1-2-00</b>	Internal Paging Timeout Selection .....	1 - 127
<b>1-2-01</b>	Intercom Call Voice/Tone Signal Selection .....	1 - 129
<b>1-2-02</b>	Automatic Callback Release Timer Selection .....	1 - 130
<b>1-2-03</b>	2-, 3-, or 4-Digit Station Number Selection.....	1 - 132
<b>1-2-04</b>	Call Arrival Key Block Assignment .....	1 - 133
<b>1-2-08</b>	Specified Station Access Code Assignment .....	1 - 135
<b>1-2-09~18</b>	Customised Message 1~10 Assignment.....	1 - 136
<b>1-2-19</b>	Intercom Ring Pattern Selection.....	1 - 137
<b>1-2-20</b>	Intercom Ring Tone Selection .....	1 - 139
<b>1-2-21</b>	PHS Telephone Assignment .....	1 - 140
<b>1-2-22</b>	Call Forward No Answer Timer Selection .....	1 - 142
<b>1-2-23</b>	System Call Park Recall Time Selection .....	1 - 144
<b>1-2-24</b>	Intercom Feature Access Code Assignment .....	1 - 146



<b>1-2-25</b>	Internal Paging Alert Tone Selection .....	1 - 148
<b>1-2-26</b>	Delayed Ringing Timer Assignment (ICM) .....	1 - 149
<b>1-2-28</b>	PS Out of Area Tone Selection.....	1 - 150
<b>1-2-30</b>	PS Out of Area Timer Selection (BSU only) .....	1 - 151
<b>1-2-31</b>	Call Pickup Group - Direct .....	1 - 152
<b>1-3-01</b>	Bounce Protect Time Selection .....	1 - 153
<b>1-3-02</b>	SLT Hookflash Signal Selection .....	1 - 154
<b>1-3-03</b>	First Digit PBR Release Timer Selection .....	1 - 155
<b>1-3-04</b>	Dial 1 (DP) Hookflash Selection .....	1 - 157
<b>1-3-05</b>	Hookflash Start Time Selection .....	1 - 158
<b>1-3-06</b>	Hookflash End Time Selection.....	1 - 159
<b>1-3-07</b>	Voice Mail Digit Add Assignment.....	1 - 160
<b>1-3-08</b>	Voice Mail DTMF Delay Timer Selection .....	1 - 161
<b>1-3-09</b>	Voice Mail Disconnect Time Selection.....	1 - 162
<b>1-3-10</b>	Voice Mail DTMF Duration/Interdigit Time Selection .....	1 - 163
<b>1-3-11</b>	SLT/PHS Talk Start Timer .....	1 - 164
<b>1-4-00</b>	Tandem Transfer Automatic Disconnect Timer Selection ....	1 - 165
<b>1-4-01</b>	Automated Attendant First Digit PBR Release Timer Selection .....	1 - 166
<b>1-4-02</b>	Automated Attendant Transfer Delayed Ringing Time Selection .....	1 - 168
<b>1-4-03</b>	Automated Attendant No Answer Disconnect Time Selection .....	1 - 170
<b>1-4-04</b>	Tandem Transfer SMDR Print Extension Assignment.....	1 - 172
<b>1-4-05</b>	Automatic Tandem Trunk by Night Mode Selection .....	1 - 173
<b>1-4-08</b>	Automated Attendant PBR Timeout Response Selection.....	1 - 174
<b>1-4-09</b>	Automated Attendant PBR Start Time Selection .....	1 - 175
<b>1-4-11</b>	Automated Attendant Message Day Night Mode Selection..	1 - 176
<b>1-4-12</b>	Automated Attendant Message to Tenant Assignment .....	1 - 177
<b>1-4-13</b>	Automated Attendant Answer Delay Time Assignment .....	1 - 178
<b>1-4-14</b>	Automated Attendant Message Access Code (1-Digit) Assignment .....	1 - 179
<b>1-4-15</b>	Automated Attendant Message Access Code (2-Digit) Assignment .....	1 - 182
<b>1-4-16</b>	Automated Attendant Message Repeat Selection .....	1 - 183
<b>1-4-17</b>	Automated Attendant Delay Announcement Hold Tone Selection .....	1 - 184
<b>1-4-18</b>	Automated Attendant Delay Announcement Assignment.....	1 - 185
<b>1-4-19</b>	Automated Attendant 1 <sup>st</sup> to 2 <sup>nd</sup> Delay Announcement Interval Time Selection .....	1 - 186
<b>1-4-20</b>	Automated Attendant Delay Announcement Disconnect Time Selection .....	1 - 187
<b>1-4-21</b>	Automated Attendant Extension Number Assignment .....	1 - 188
<b>1-4-22</b>	Automated Attendant Direct Extension Ring or Ring Assignment .....	1 - 189
<b>1-5-02</b>	SMDR Print Format .....	1 - 191
<b>1-5-13</b>	Printer Connected Selection .....	1 - 192

<b>1-5-14</b>	Printer Line Feed Control Selection .....	1 - 193
<b>1-5-23</b>	Outgoing Mode Selection .....	1 - 194
<b>1-5-25</b>	SMDR Valid Call Timer Assignment.....	1 - 195
<b>1-5-26</b>	SMDR Incoming/Outgoing Print Selection .....	1 - 196
<b>1-6-00</b>	Attendant Add-On Console to Telephone Port Assignment .	1 - 197
<b>1-6-03</b>	DSS Call Voice/Tone Signal Selection .....	1 - 198
<b>1-6-05</b>	Attendant Add-On Console Key Selection .....	1 - 199
<b>1-6-08</b>	Attendant Transfer Selection During Live Record .....	1 - 202
<b>1-7-00</b>	Doorphone Assignment .....	1 - 203
<b>1-7-01</b>	Doorphone Display Time Selection .....	1 - 204
<b>1-7-02</b>	External Speaker Connection Selection.....	1 - 206
<b>1-7-03</b>	External Paging Alert Tone Selection.....	1 - 207
<b>1-7-04</b>	Doorphone Ringing Pattern Selection .....	1 - 208
<b>1-7-05</b>	Doorphone Ringing Frequency Selection.....	1 - 209
<b>1-7-06</b>	External Paging Timeout Selection .....	1 - 210
<b>1-7-07</b>	External Ring Relay Cycle Selection.....	1 - 212
<b>1-7-08</b>	External Speaker Chime Selection.....	1 - 214
<b>1-7-09</b>	External Speaker Chime Start Time Selection .....	1 - 215
<b>1-8-01</b>	SLT or Automated Attendant/DISA to PBR Selection .....	1 - 217
<b>1-8-02</b>	PBR Receive Level Assignment for Automated Attendant/ DISA .....	1 - 218
<b>1-8-04</b>	Time Display (12h/24h) Selection .....	1 - 219
<b>1-8-07</b>	Class of Service (Attendant) Feature Selection 1 .....	1 - 220
<b>1-8-08</b>	Class of Service (Station) Feature Selection 2.....	1 - 223
<b>1-8-09</b>	Music on Hold Pattern Selection .....	1 - 228
<b>1-8-10</b>	PBR Interdigit Release Timer Selection .....	1 - 229
<b>1-8-11</b>	System Refresh Timer Assignment.....	1 - 231
<b>1-8-12</b>	VRS Message Recording Time Selection .....	1 - 232
<b>1-8-13</b>	VRS Message Function Assignment.....	1 - 233
<b>1-8-15</b>	Tone Assignment .....	1 - 234
<b>1-8-16</b>	Voice Prompt to Tone Assignment.....	1 - 237
<b>1-8-17</b>	PC Programming Password Assignment .....	1 - 238
<b>1-8-18</b>	Site Name Assignment.....	1 - 239
<b>1-8-25</b>	ACD/UCD Group Agent Assignment.....	1 - 240
<b>1-8-26</b>	Voice Mail Quick Transfer Master Hunt Number.....	1 - 241
<b>1-8-27</b>	Forced Account Code Length Assignment.....	1 - 242
<b>1-8-29</b>	SCD (Simplified Call Distribution) Pilot Number Assignment.....	1 - 243
<b>1-8-30</b>	SCD Group Agent Assignment.....	1 - 244
<b>1-8-31</b>	Hold Tone Source Selection.....	1 - 245
<b>1-8-32</b>	Hold Internal Tone Volume Selection.....	1 - 246
<b>1-8-33</b>	Master Clock Selection.....	1 - 247
<b>1-8-35</b>	COM Port Baud Rate Setting Assignment .....	1 - 248
<b>1-8-36</b>	COM Port Parity/Stop Bit Setting Assignment.....	1 - 249
<b>1-8-37</b>	General Purpose Relay Assignment .....	1 - 250
<b>1-8-38</b>	Modem Port for Remote Programming Assignment.....	1 - 251
<b>1-8-40</b>	ACD Hunt Timer .....	1 - 252
<b>1-8-47</b>	CAR for Voice Mail Message Notice Assignment .....	1 - 253

<b>1-8-49</b>	New AA-Info Yes/No Selection .....	1 - 254
<b>1-9-00</b>	DISA/ID Code Assignment .....	1 - 255
<b>1-9-02</b>	DISA/ID Password Effect/Invalid Selection.....	1 - 256
<b>1-9-03</b>	ID Restriction Class Assignment (Day Mode).....	1 - 257
<b>1-9-04</b>	ID Restriction Class Assignment (Night Mode).....	1 - 259
<b>1-11-00</b>	T1 Signal Format Selection .....	1 - 261
<b>1-11-01</b>	Clear Channel Selection .....	1 - 262
<b>1-11-02</b>	Line Length Selection .....	1 - 263
<b>1-11-03</b>	IP K-CCIS Selection .....	1 - 264
<b>1-11-05</b>	TI Channel Selection .....	1 - 265
<b>1-11-06</b>	Signalling Selection .....	1 - 266
<b>1-11-07</b>	DTI Trunk Type Assignment .....	1 - 267
<b>1-11-08</b>	Digits Delete for TI ANI Assignment .....	1 - 268
<b>1-12-00</b>	ACD/UCD Group Pilot Number Assignment.....	1 - 271
<b>1-12-01</b>	ACD/UCD Group Overflow Destination Assignment .....	1 - 272
<b>1-12-02</b>	ACD/UCD Overflow Timer Selection .....	1 - 273
<b>1-13-00</b>	PRI Channel Assignment.....	1 - 275
<b>1-13-04</b>	PRT B Channel Outgoing Priority Selection .....	1 - 277
<b>1-13-05</b>	PRT B Channel-to-Trunk Group Assignment .....	1 - 278
<b>1-14-00</b>	ACR Feature Allow/Deny Selection .....	1 - 281
<b>1-14-01</b>	ACR Dialling Assignment.....	1 - 282
<b>1-14-02</b>	ACR Dialed Number Dial Allow/Deny Selection .....	1 - 284
<b>1-14-03</b>	ACR Route Table Number Assignment .....	1 - 286
<b>1-14-04</b>	ACR Trunk Group to Route Number Assignment.....	1 - 287
<b>1-14-05</b>	ACR Digit Delete Assignment .....	1 - 288
<b>1-14-06</b>	ACR Digit Add Assignment.....	1 - 289
<b>1-14-07</b>	ACR Max Digit Assignment .....	1 - 290
<b>1-15-00</b>	K-CCIS Main/Remote Office Selection .....	1 - 291
<b>1-15-02</b>	Common Signal Channel Assignment .....	1 - 293
<b>1-15-03</b>	Originating Point Code Assignment.....	1 - 295
<b>1-15-04</b>	Destination Point Code Assignment .....	1 - 297
<b>1-15-05</b>	Destination Point Code Transfer Assignment.....	1 - 299
<b>1-15-06</b>	Originating Office Code Number Assignment .....	1 - 302
<b>1-15-07</b>	K-CCIS Message Response Timeout Assignment .....	1 - 304
<b>1-15-08</b>	Link Reconnect Allow/Deny Selection .....	1 - 306
<b>1-15-09</b>	K-CCIS Maximum Call Forwarding Hop Assignment .....	1 - 308
<b>1-15-10</b>	Calling Name Display Allow/Deny Selection.....	1 - 310
<b>1-15-11</b>	Centralised Billing Allow/Deny Selection .....	1 - 312
<b>1-15-12</b>	Centralised Billing – Point Code of Centre Office Assignment .....	1 - 314
<b>1-15-13</b>	Centralised Day/Night Switching for Remote Office Assignment.....	1 - 316
<b>1-15-14</b>	Centralised Day/Night Switching for Main Office Assignment .....	1 - 318
<b>1-15-15</b>	Centralised BLF Send Point Code Assignment .....	1 - 320
<b>1-15-16</b>	Centralised BLF Send Extension Number Assignment .....	1 - 322
<b>1-15-17</b>	Centralised BLF Send Time Assignment.....	1 - 324
<b>1-15-18</b>	Centralised BLF Receive Extension Number Assignment....	1 - 326

<b>2-01</b>	Trunk to Tenant Assignment .....	1 - 329
<b>2-05</b>	Line Key Selection.....	1 - 331
<b>2-06</b>	Line Key Selection for Tenant Mode .....	1 - 332
<b>2-07</b>	System Speed Dial Display Assignment .....	1 - 335
<b>2-08</b>	ECR Relay to Tenant Assignment.....	1 - 337
<b>2-09</b>	Dial-In Tenant Incoming Limit Assignment.....	1 - 338
<b>3-00</b>	Trunk Name/Number Assignment .....	1 - 339
<b>3-02</b>	Trunk Status Selection .....	1 - 340
<b>3-03</b>	Trunk-to-Trunk Group Assignment.....	1 - 341
<b>3-04</b>	Trunk-to-Trunk Transfer Yes/No Selection.....	1 - 342
<b>3-05</b>	Trunk Incoming Answer Mode Selection .....	1 - 343
<b>3-06</b>	Automatic Tandem Trunk Assignment .....	1 - 345
<b>3-07</b>	CO/PBX Ringing Variation Selection.....	1 - 346
<b>3-11</b>	CO External Source Selection.....	1 - 347
<b>3-12</b>	CO Hold Melody Selection (CO) .....	1 - 348
<b>3-14</b>	Tie/DID Line Type Assignment.....	1 - 350
<b>3-15</b>	Trunk DTMF Duration/Interdigit Selection .....	1 - 351
<b>3-16</b>	Tie Line Prepause Time Selection .....	1 - 352
<b>3-17</b>	Tie Line Answer Detect Time Selection .....	1 - 353
<b>3-18</b>	Tie Line Release Detect Time Selection .....	1 - 354
<b>3-19</b>	Tie Line/CO/PBX Incoming Signal Detect Time Selection ....	1 - 356
<b>3-20</b>	Tie Line Loop Off-Guard Time Selection.....	1 - 358
<b>3-21</b>	Tie Line Length of Wink Signal Selection .....	1 - 359
<b>3-22</b>	Tie Line Length of Delay Signal Selection.....	1 - 361
<b>3-24</b>	Tie Line Incoming Interdigit Timeout Selection .....	1 - 363
<b>3-25</b>	Tie Line Wink/Delay Signal Detect Timeout Selection .....	1 - 365
<b>3-27</b>	Tie Line Dial Tone Selection .....	1 - 367
<b>3-28</b>	Tie Line Reorder Tone Selection.....	1 - 368
<b>3-29</b>	Trunk Internal Transmit Pad Selection .....	1 - 369
<b>3-30</b>	Trunk Internal Receive Pad Selection .....	1 - 371
<b>3-31</b>	Trunk External Transmit Pad Selection.....	1 - 373
<b>3-32</b>	Trunk External Receive Pad Selection.....	1 - 375
<b>3-33</b>	Disconnect Recognition Time Selection.....	1 - 377
<b>3-38</b>	Automated Attendant Message to Trunk Selection .....	1 - 378
<b>3-39</b>	Automatic Release Selection .....	1 - 379
<b>3-41</b>	ACD/UCD Delay Announcement Assignment.....	1 - 380
<b>3-42</b>	DIT Assignment.....	1 - 381
<b>3-43</b>	ANA Assignment .....	1 - 382
<b>3-44</b>	Caller ID Display Assignment for CO/PBX Line .....	1 - 383
<b>3-45</b>	Live Recording Trunk Selection .....	1 - 384
<b>3-52</b>	ISDN Trunk Directory Number Assignment.....	1 - 385
<b>3-53</b>	Caller Name Indication Selection .....	1 - 386
<b>3-57</b>	ISDN Dial-Out Sending Selection.....	1 - 388
<b>3-59</b>	Automated Attendant Function Selection .....	1 - 389

<b>3-61</b>	DIT Delay Answer Timer Selection .....	1 - 390
<b>3-62</b>	DIT Tenant Assignment .....	1 - 392
<b>3-63</b>	DIT Holiday Mode Enable .....	1 - 394
<b>3-64</b>	DIT Night Mode Delay Answer Enable .....	1 - 395
<b>3-65</b>	Hold Tone Automated Attendant Selection .....	1 - 396
<b>3-67</b>	CO Line Ringing Pattern Selection for CO/PBX Line Mode .....	1 - 397
<b>3-70</b>	CIC Number Assignment .....	1 - 399
<b>3-71</b>	Caller Name Display Assignment .....	1 - 400
<b>3-72</b>	ISDN BRT Connection Configuration .....	1 - 401
<b>3-90</b>	Polarity Reverse Selection.....	1 - 402
<b>3-91</b>	Trunk Type Selection.....	1 - 403
<b>3-92</b>	Trunk (Installed, DP/DTMF) Selection .....	1 - 404
<b>4-01</b>	CO/PBX Ring Assignment (Day Mode) .....	1 - 405
<b>4-02</b>	CO/PBX Ring Assignment (Night Mode) .....	1 - 407
<b>4-03</b>	Doorphone Chime Assignment (Day Mode).....	1 - 409
<b>4-04</b>	Doorphone Chime Assignment (Night Mode).....	1 - 410
<b>4-05</b>	Automatic Outgoing CO/PBX Line Selection .....	1 - 411
<b>4-07</b>	Code Restriction Class Assignment (Day Mode).....	1 - 414
<b>4-08</b>	Code Restriction Class Assignment (Night Mode).....	1 - 415
<b>4-09</b>	Telephone to Tenant Assignment.....	1 - 416
<b>4-10</b>	Station Number Assignment.....	1 - 417
<b>4-11</b>	Ringling Line Preference Selection .....	1 - 418
<b>4-12</b>	Line Key Selection for Telephone Mode.....	1 - 419
<b>4-13</b>	CO/PBX Busy Forward Station Assignment.....	1 - 421
<b>4-14</b>	Intercom Master Hunt Number Selection.....	1 - 422
<b>4-15</b>	Intercom Master Hunt Number Forward Assignment .....	1 - 423
<b>4-17</b>	Station to Class of Service Feature Assignment .....	1 - 424
<b>4-18</b>	Station Name Assignment .....	1 - 425
<b>4-19</b>	Trunk Outgoing Restriction .....	1 - 426
<b>4-23</b>	Prime Line/Hot Line Assignment .....	1 - 428
<b>4-24</b>	SLT Hookflash Assignment .....	1 - 429
<b>4-26</b>	DISA/ID Number Station Assignment.....	1 - 430
<b>4-27</b>	ID Outgoing Restriction Selection.....	1 - 431
<b>4-28</b>	Multilingual LCD Indication Selection .....	1 - 434
<b>4-29</b>	HFU Selection.....	1 - 435
<b>4-30</b>	Hold/Transfer Recall Display Selection .....	1 - 436
<b>4-31</b>	Receiving Internal/All Call Page Selection.....	1 - 437
<b>4-32</b>	Trunk Digit Restriction .....	1 - 438
<b>4-35</b>	Voice Mail/SLT Selection.....	1 - 439
<b>4-36</b>	Voice Prompt Selection .....	1 - 440
<b>4-37</b>	Extension Line Key Ring Assignment (Day Mode) .....	1 - 441
<b>4-38</b>	Extension Line Key Ring Assignment (Night Mode) .....	1 - 443
<b>4-39</b>	APR Ring Mode Assignment .....	1 - 445
<b>4-40</b>	LCR Class Selection.....	1 - 446
<b>4-41</b>	SIE/CAR Ringing Line Preference Selection .....	1 - 447
<b>4-42</b>	Call Forward-Busy Immediately/Delay Selection.....	1 - 448
<b>4-43</b>	Station to Call Appearance Block Assignment .....	1 - 449

<b>4-44</b>	Caller ID/Preset Dial Outgoing CO Selection .....	1 - 450
<b>4-46</b>	Live Record Auto Delete .....	1 - 451
<b>4-47</b>	ISDN Directory Number Selection .....	1 - 452
<b>4-49</b>	Caller ID Display for CAR Key.....	1 - 454
<b>4-50</b>	Multiline Terminal Type Selection .....	1 - 455
<b>4-51</b>	Off-Hook Ringing Selection.....	1 - 457
<b>4-52</b>	CO/PBX Answer Key Operation without Ringing Assignment (Day Mode).....	1 - 458
<b>4-53</b>	CO/PBX Answer Key Operation with-out Ringing Assignment (Night Mode).....	1 - 459
<b>4-55</b>	CO Ringing Pattern Selection for Telephone Mode .....	1 - 460
<b>4-56</b>	SMDR Telephone Print Selection .....	1 - 462
<b>4-57</b>	CO Line Ringing Pattern by Telephone or CO Selection .....	1 - 463
<b>4-58</b>	Automated Attendant DID Assignment .....	1 - 464
<b>4-59</b>	APR Hookflash Selection .....	1 - 465
<b>4-61</b>	Station Name/Number Display Selection .....	1 - 466
<b>4-62</b>	ISDN Extension-based Caller ID Assignment .....	1 - 467
<b>4-64</b>	Timer Class Assignment for Telephone Mode Selection .....	1 - 468
<b>4-65</b>	Code Restriction Class Assignment CFVA Restricted Tel/Night Mode .....	1 - 470
<b>4-66</b>	ACD Plus Hold Tone Selection .....	1 - 471
<b>4-67</b>	IP Station Number Assignment .....	1 - 472
<b>4-68</b>	LCD Line Key – Name Assignment.....	1 - 473
<b>4-90</b>	SLT Data Line Security Assignment .....	1 - 475
<b>4-91</b>	Telephone Ringing Variation Selection .....	1 - 476
<b>4-92</b>	Receiving Volume Selection.....	1 - 477
<b>4-93</b>	Internal Zone Paging Selection .....	1 - 478
<b>4-94</b>	3-Minute Alarm Selection .....	1 - 479
<b>4-95</b>	DTMF/DP SLT Type Selection .....	1 - 480
<b>5-00</b>	Digit Add/Del for Tie Line Networking .....	1 - 481
<b>5-01</b>	Tie Line Networking Tandem Connection Assignment .....	1 - 483
<b>5-02</b>	8-Digit Matching Table to Trunk Group Assignment .....	1 - 485
<b>5-03</b>	OCC Table to Trunk Group Assignment .....	1 - 486
<b>5-04</b>	LCR Class to Trunk Group Selection .....	1 - 487
<b>5-05</b>	Common Signalling Channel Route Assignment .....	1 - 489
<b>5-06</b>	Trunk Group Outgoing Priority Selection.....	1 - 491
<b>6-2</b>	Tenant Mode Copy Assignment .....	1 - 493
<b>6-3</b>	CO Line Mode Copy Assignment .....	1 - 495
<b>6-4</b>	Telephone Mode Copy Assignment .....	1 - 497
<b>6-5</b>	Trunk Group Mode Copy Assignment .....	1 - 499
<b>7-1</b>	Card Interface Slot Assignment.....	1 - 501
<b>7-2</b>	Telephone Type Assignment.....	1 - 507

	<b>7-3-00</b>	MIF (ACD) Assignment.....	1 - 508
	<b>7-3-01</b>	MIF (LCR) Assignment .....	1 - 509
	<b>7-3-02</b>	MIF (SMDR) Assignment.....	1 - 510
	<b>7-3-03</b>	MIF (UCD) Assignment.....	1 - 511
	<b>7-3-04</b>	MIF (Caller ID) Assignment .....	1 - 512
	<b>8-1</b>	ROM Version Confirmation .....	1 - 513
	<b>8-2</b>	System Speed Dial Memory Clear.....	1 - 515
	<b>8-3</b>	Station Speed Dial Memory Clear .....	1 - 516
	<b>8-8-8800</b>	Second Initialisation.....	1 - 517
	—	Clock/Calendar Setting .....	1 - 518
<b>Section 5</b>		Function Timer Chart .....	1 - 521
<b>Section 6</b>		Code Restriction.....	1 - 527
<b>Section 7</b>		Character Code Tables .....	1 - 541
<b>Section 8</b>		Display Abbreviations.....	1 - 544

## *Chapter 2 Guide to Feature Programming*

<b>Section 1</b>	General Information .....	2 - 547
<b>Section 2</b>	Programming Guide Tables .....	2 - 547

## *Chapter 3 PC Programming*

<b>Section 1</b>	General Information .....	3 - 599
<b>Section 2</b>	Features of PC Programming .....	3 - 599
<b>Section 3</b>	Software Installation.....	3 - 600
<b>Section 4</b>	Wizard .....	3 - 600
<b>Section 5</b>	Programming Screens .....	3 - 603
<b>Section 6</b>	Toolbar .....	3 - 605
<b>Section 7</b>	Xen IPK Pulldown Menus.....	3 - 607

THIS PAGE INTENTIONALLY LEFT BLANK



# List of Figures

## Chapter 1 Multiline Terminal Programming

<b>Section 1 General Information</b>	No figures for this section.
<b>Section 2 Programming the System</b>	No figures for this section.
Figure 1-1: Programming Flowchart .....	1 - 2
Figure 1-2: Xen IPK Multiline Terminal .....	1 - 5
Figure 1-3: Page Display for 16-Key and 24-Key Multiline Terminals.....	1 - 8
Figure 1-4: Page Switching for Data Values .....	1 - 9
<b>Section 4 Programming System Data</b>	No figures for this section.
<b>Section 5 Function Timer Chart</b>	No figures for this section.
<b>Section 6 Code Restriction</b>	No figures for this section.
<b>Section 7 Character Code Tables</b>	No figures for this section.
<b>Section 8 Display Abbreviations</b>	No figures for this section.

## Chapter 2 Guide to Feature Programming

<b>Section 1 General Information</b>	No figures for this section.
<b>Section 2 Programming Guide Tables</b>	No figures for this section.

## Chapter 3 PC Programming

<b>Section 1 General Information</b>	No figures for this section.
<b>Section 2 Features of PC Programming</b>	No figures for this section.
<b>Section 3 Software Installation</b>	No figures for this section.
<b>Section 4 Wizard</b>	No figures for this section.
Figure 3-1: Accessing Wizard .....	3 - 601
Figure 3-2: Selecting Wizard for a Feature .....	3 - 601
Figure 3-3: Sample Wizard .....	3 - 602

<b>Section 5 Programming Screens</b>	No figures for this section.
Figure 3-4: Xen IPK Maintenance Access Terminal Software Screen Samples .....	3 - 604
<b>Section 6 Toolbar</b>	No figures for this section.
<b>Section 7 Xen IPK Pulldown Menus</b>	No figures for this section.
Figure 3-5: File Menu .....	3 - 607
Figure 3-6: Edit Menu .....	3 - 609
Figure 3-7: Basic Menu .....	3 - 610
Figure 3-8: Application Menu.....	3 - 612
Figure 3-9: User Menu.....	3 - 614
Figure 3-10: Communications Menu .....	3 - 615
Figure 3-11: Help Menu.....	3 - 617

# List of Tables

---

## Chapter 1 Multiline Terminal Programming

<b>Section 1 General Information</b>	No figures for this section.
<b>Section 2 Programming the System</b>	No figures for this section.
Table 1-1: Programming Modes .....	1 - 3
Table 1-2: System Data .....	1 - 10
<b>Section 4 Programming System Data</b>	No figures for this section.
<b>Section 5 Function Timer Chart</b>	No figures for this section.
Table 1-3: Function Timer Chart.....	1 - 521
<b>Section 6 Code Restriction</b>	No figures for this section.
<b>Section 7 Character Code Tables</b>	No figures for this section.
Table 1-4: System Data Input .....	1 - 541
Table 1-5: Speed Dial Name Input .....	1 - 542
<b>Section 8 Display Abbreviations</b>	No figures for this section.
Table 1-6: Abbreviations Used in Multiline Terminal Displays .....	1 - 544

## Chapter 2 Guide to Feature Programming

<b>Section 1 General Information</b>	No figures for this section.
<b>Section 2 Programming Guide Tables</b>	No figures for this section.

## Chapter 3 PC Programming

<b>Section 1 General Information</b>	No figures for this section.
<b>Section 2 Features of PC Programming</b>	No figures for this section.
<b>Section 3 Software Installation</b>	No figures for this section.
<b>Section 4 Wizard</b>	No figures for this section.
<b>Section 5 Programming Screens</b>	No figures for this section.
<b>Section 6 Toolbar</b>	No figures for this section.
<b>Section 7 Xen IPK Pulldown Menus</b>	No figures for this section.

THIS PAGE INTENTIONALLY LEFT BLANK

# Preface

---

About this manual.

The Programming Manual was developed primarily for the technician and provides all necessary information for programming the Xen IPK system.

Programming can be accomplished using either a PC or a Multiline Terminal.

## SECTION 1 MANUAL ORGANISATION

This manual provides instructions for programming the Xen system.

### Chapter 1 – Multiline Terminal Programming

This chapter includes all of the Memory Blocks used to program the system. Detailed programming instructions are provided for each Memory Block.

### Chapter 2 – Guide to Feature Programming

This chapter includes a list by feature of the Memory Blocks necessary for programming each feature.

### Chapter 3 – PC Programming

This chapter includes the instruction or programming using Xen PC software.

## SECTION 2 SUPPORTING DOCUMENTS

The Xen system has a set of manuals that provide all the information necessary to install and support the system. The remaining manuals which comprise the set are described below.

### Features and Specifications Manual

This manual provides detailed information related to every feature available in the system.

### System Hardware Manual

The System Hardware Manual is provided for the system installer. This manual provides detailed instructions for installing the Xen KSU, ETUs, Multiline Terminals, and optional equipment.

### Least Cost Routing Manual

This manual provides instructions to the service technician for programming the customer site for least cost routing.

## **Automatic Call Distribution Manual**

This manual provides the service technician with instructions for programming the ACD. This manual can also be used by the ACD supervisor at the customer site to become familiar with the ACD/MIS feature.

# *Disclaimer*

---

NEC shall not be liable for any direct, indirect, consequential or incidental damages about the use of this equipment, manual or any related materials. The information in this technical manual is advisory in nature and is subject to change. NEC may make improvements and changes in the products described in this manual without notice. Changes will be periodically made to the information in the new editions. Efforts have been made to ensure that the contents of this manual are correct. Should you find any error, NEC welcomes your comments to improve our communications. Please contact NEC on 1800 036 136.

Contents of this manual are subject to change without prior notice at the discretion of NEC Business Solutions Ltd. This document has been prepared for the use of employees and customers of NEC Business Solutions Ltd and may not be reproduced without prior written approval of NEC Business Solutions Ltd.

Copyright 2004

NEC Business Solutions Ltd  
633 Springvale Road  
Mulgrave Vic 3170

THIS PAGE INTENTIONALLY LEFT BLANK



# Multiline Terminal Programming

## SECTION 1 GENERAL INFORMATION

The Xen IPK system is a stored-program controlled system. When the system is initially powered up, the CPU scans each possible interface slot to determine the hardware configuration. The system stores this information and the default values in the resident system program memory. After initially powering up the system, a trained technician can change the resident system program to meet the specific needs of an individual customer.

## SECTION 2 PROGRAMMING THE SYSTEM



*The battery on the CPU must be connected. If the battery is not connected before the programming begins, data may be lost if a power outage occurs.*

System data programming may be necessary when:

- ④ The system is installed for the first time.
- ④ Components of an existing system are replaced.

- Functions of an existing system are changed.

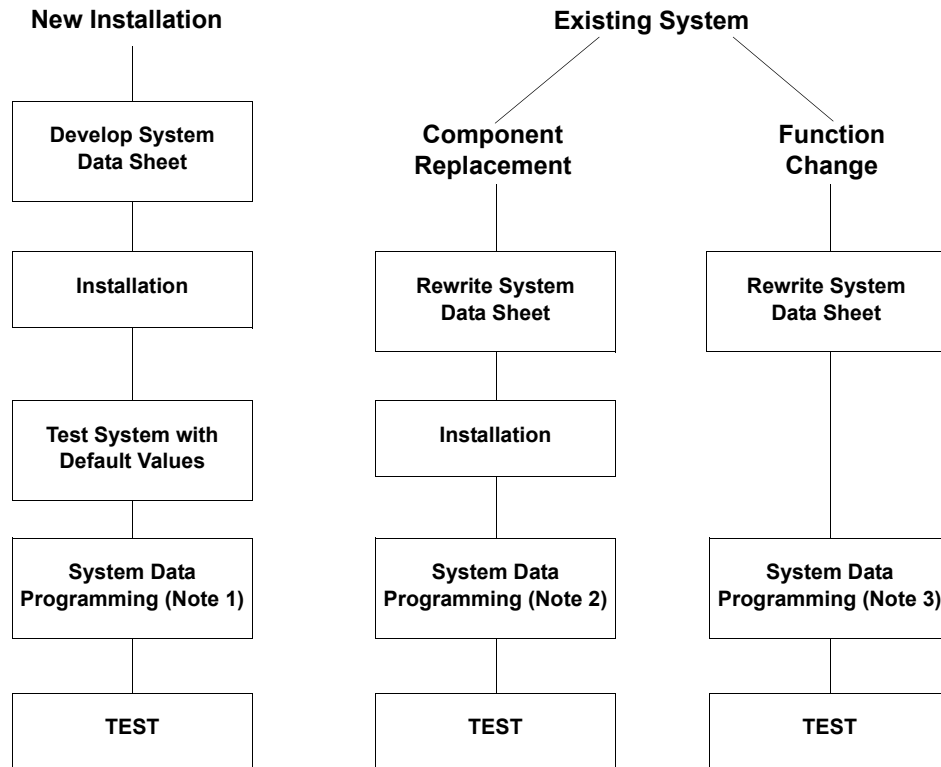

Note 1: For new installations, system default values are assigned when the power is turned on. Therefore, only program the system data to be changed.

Note 2: For component replacements, program the relevant system data.

Note 3: For function changes, program the system data to be revised.

**Figure 1-1:** Programming Flowchart

## 2.1 Features of Programming

The following features are provided with Multiline Programming:

- The system operates from default after initial power-up. The technician needs to program only the parameters that change from the default assignments.
- System programming characters are displayed on the LCD of the Multiline Terminal.
- Several types of system programming can be entered at the same time.
- Data programmed for one telephone (e.g., Tenant Mode, CO/PBX Line Mode, or Telephone Mode) can be copied to another telephone.
- Two Multiline Terminals can be used simultaneously for programming. These terminals are connected to ports 01 and 02.

## 2.2 System Programming Modes

System programming has eight modes and some modes have submodes. The modes and submodes are listed in *Table 1-1: Programming Modes*.

**Table 1-1: Programming Modes**

Line Key	Mode Name	Line Key	Submode Name
LK 1	System Mode	LK 1	CO Line
		LK 2	ICM
		LK 3	SLT
		LK 4	Transfer/Automated Attendant
		LK 5	SMDR/LCR
		LK 6	DSS
		LK 7	ESP
		LK 8	PBR/Miscellaneous
		LK 9	DISA
		LK 10	CAR
		LK 11	DTI
		LK 12	ACD/UCD
		LK 13	PRI ISDN
		LK 14	ACR
		LK 15	K-CCIS
LK 2	Tenant Mode	N/A	N/A
LK 3	CO/PBX Line Mode	N/A	N/A
LK 4	Telephone Mode	N/A	N/A
LK 5	Trunk Group Mode	N/A	N/A
LK 6	Copy Mode	LK 2	Tenant Mode Copy Assignment
		LK 3	CO Line Mode Copy Assignment
		LK 4	Telephone Mode Copy Assignment
		LK 5	Trunk Group Mode Copy Assignment
LK 7	ETU Mode	LK 1	Card Interface Slot Assignment
		LK 2	Telephone Type Assignment
		LK 3	MIF Assignment
LK 8	Special Mode	LK 1	ROM Version Confirmation
		LK 2	System Speed Dial Memory Clear
		LK 3	Station Speed Dial Memory Clear
		LK 8	Second Initialisation

## 2.3 Before Programming

The technician should check the ROM version and the port numbers before programming the system.

### 2.3.1 Check Points

#### ④ Confirming the ROM Version

The features that are available depend on the ROM version. Refer to Memory Block 8-1 (ROM Version Confirmation).

#### ④ Confirming the Port Number

Port numbers are used for system programming. Refer to Memory Block 7-1 (Card Interface Slot Assignment).

To confirm station numbers press **Feature** and **4**. The display indicates the station number and the port number.

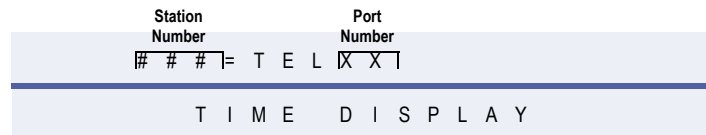

### 2.3.2 Preliminary Points

#### ④ Selecting System Programming

Refer to *Section 2 Programming the System on page 1-1*.

## 2.4 Writing System Data

After turning on the system, system data can be programmed using a Multiline Terminal that is connected to ports 01 or 02 (the Multiline Terminal must be idle). System programming can be performed while other Multiline Terminals in the system are in use. Some data is written into memory immediately after the programming process, while other data is not written until the stations or trunks are idle. When the data is not written until a station or trunk is idle, the station LCD displays 'DATA ENTRY' even after the programming process is completed. This indicates that system data entry is still in progress. When the in-use stations become idle, the data is written and the station LCD displays only the time.

The data programmed for the following Memory Blocks is not written while the Multiline Terminals or PBRs are in use:

#### ④ When Multiline Terminals are in use:

- Memory Block 2-01 (Trunk to Tenant Assignment)
- Memory Block 2-05 (Line Key Selection)
- Memory Block 2-07 (System Speed Dial Display Assignment)
- Memory Block 4-09 (Telephone to Tenant Assignment)

- ☎ When the PBR is in use:
  - Memory Block 1-8-01 (SLT or Automated Attendant/DISA to PBR Selection)
  - Memory Block 1-8-02 (PBR Receive Level Assignment for Automated Attendant/DISA)

## 2.5 Programming Methods

### 2.5.1 Initialising the System

Turn the new Key Service Unit (KSU) power supply on. After 30 seconds, the system operates with the system default values.

### 2.5.2 Using the Multiline Terminal for Programming





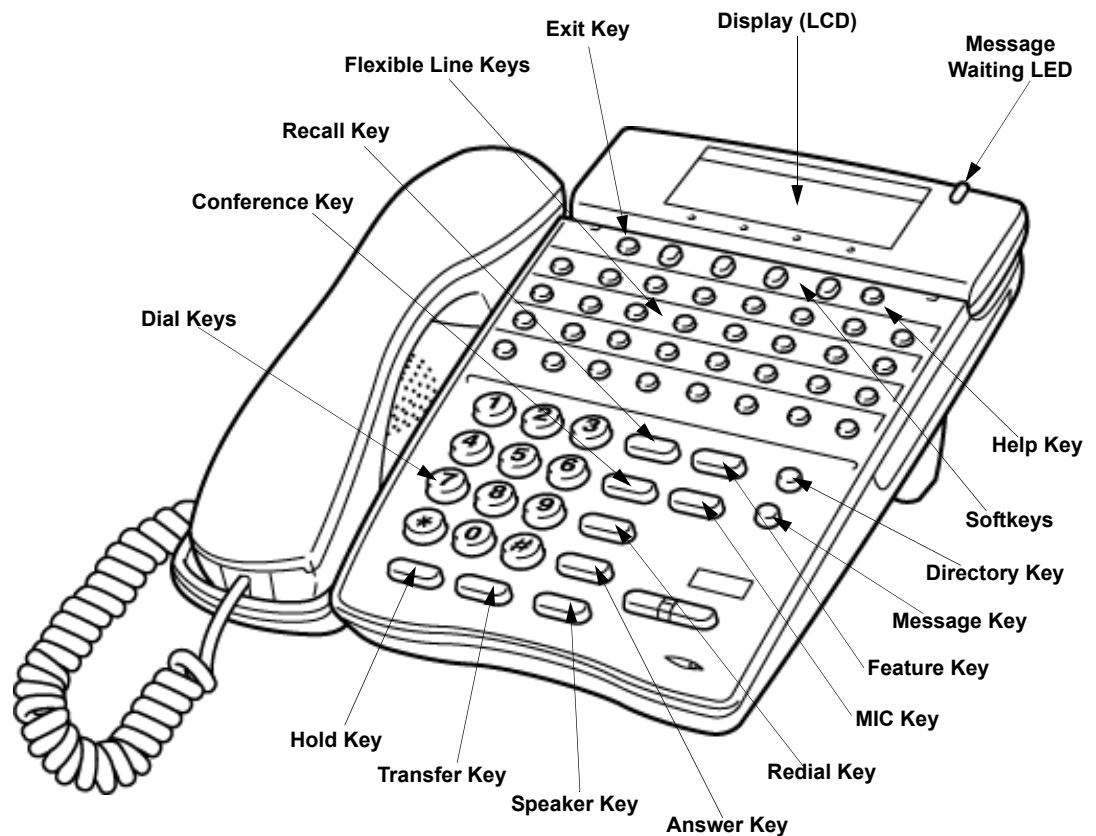



















System programming can be performed using a display type Multiline Terminal that is connected to station ports 01 or 02.

Refer to *Figure 1-2: Xen IPK Multiline Terminal*



**Figure 1-2:** Xen IPK Multiline Terminal

Figure 1-2: Xen IPK Multiline Terminal provides a list and description of the keys used during Multiline Terminal Programming.

Key	Description
	Used to enter data from the dial pad and to specify a Memory Block location.
	Used to move the cursor to the left. The cursor moves one character space to the left each time  is pressed.
	Used to move the cursor to the right. The cursor moves one character space to the right each time  is pressed.
	Used to select another mode. Press  to switch modes as follows: Mode or submode selection: Returns to Program Mode. Data No. Mode: Return to a mode or submode selection, or Program Mode (if no submode exists).
	Each time the conference key is pressed, Memory Block item changes are as follows: Tenant Mode: The tenant number increments by one. CO/PBX Line Mode: The CO/PBX line number increments by one. Telephone Mode: The telephone port number increments by one. Trunk Group Mode: The Trunk group number increments by one.
	Future use.
	Used to return to the <b>previous</b> page in system programming.
	Future use.
	Used to enter a pause in speed dial programming mode or to clear data in system programming mode.
	Flexible Line keys are used to specify a mode or submode when selecting a Memory Block or to select programming data for input.
	Used to proceed to the <b>next</b> page in system programming.
	This key is used to enter a pause, hyphen, asterisk and pound. To enter an asterisk or pound:  +  = *  +  = # The Message Waiting LED turns on and off after  and  are pressed.
	Used to exit the programming mode (go back on-line).
	Used to write (save) data. After entering data press  , the data is written into memory. The next Memory Block is displayed.

### 2.5.3 Entering Programming Mode

To program information in the system, the following digital Multiline Terminals can be used as programming stations. Two stations, ports 01 and 02, are automatically assigned as programming stations.

- ④ DTU-16D-1A (BK)/(WH) TEL
- ④ DTU-32D-1A (BK)/(WH) TEL
- ④ DTR-8D-1A( ) TEL
- ④ DTR-16D-1A( ) TEL
- ④ DTR-32D-1A( ) TEL

To enter programming mode, the station must be off-line. To go off-line:

1. Press **Feature**.
2. Press **Hold**.
3. Dial **#**, **0**, and **\*** in sequence. The Multiline Terminal LCD indicates program mode is now active.



While off-line, the programming terminal cannot be signalled by any system station. Off-line mode does not timeout.

### 2.5.4 Page Switching

In Memory Block 1-1-18 (System Speed Dial Restriction by Tenant) tenant numbers 00~07 are assigned to Flexible Line keys on the first page. Tenant number 08~15 are assigned to the Flexible Line keys on the second page. The tenant number corresponding to Flexible Line key 1 of the current page is displayed on the right side of the display.

During system programming, a value (data) is assigned to each Flexible Line key. When there are more values than Flexible Line keys, value assignments are displayed on additional pages. The associated data can be entered on that page. The page number is displayed at the right side of the LCD.

Figure 1-3 Page Switching for 16-Key and 24-Key multiline Terminals shows an example of CO/PBX line keys on each page and their corresponding tenant numbers. In all cases each page is represented by eight line keys.

To navigate between pages, use **Recall** to access the *next* page and **Feature** to return to the *previous* page.

**16-Key Multiline Terminal**

**24-Key Multiline Terminal**

**(Page 1)**

**(Page 1)**

LK 1	LK 2	LK 3	LK 4
00	01	02	03
LK 5	LK 6	LK 7	LK 8
04	05	06	07
LK 9	LK 10	LK 11	LK 12
08	09	10	11
LK 13	LK 14	LK 15	LK 16
12	13	14	15

LK 1	LK 2	LK 3	LK 4	LK5	LK6
00	01	02	03	04	05
LK 7	LK 8	LK 9	LK 10	LK 11	LK 12
06	07	08	09	10	11
LK 13	LK 14	LK 15	LK 16	LK 17	LK 18
12	13	14	15	16	17
LK 19	LK 20	LK 21	LK 22	LK 23	LK 24
18	19	20	21	22	23

**LCD Display:**  
**00 to indicate Page 1**

**LCD Display:**  
**00 to indicate Page 1**

**(Page 2)**

**(Page 2)**

LK 1	LK 2	LK 3	LK 4
08	09	10	11
LK 5	LK 6	LK 7	LK 8
12	13	14	15
LK 9	LK 10	LK 11	LK 12
16	17	18	19
LK 13	LK 14	LK 15	LK 16
20	21	22	23

LK 1	LK 2	LK 3	LK 4	LK5	LK6
08	09	10	11	12	13
LK 9	LK 8	LK 9	LK 10	LK 11	LK 12
14	15	16	17	18	19
LK 13	LK 14	LK 15	LK 16	LK 17	LK 18
20	21	22	23	24	25
LK 19	LK 20	LK 21	LK 22	LK 23	LK 24
26	27	28	29	30	31

**LCD Display:**  
**08 to indicate Page 2**

**LCD Display:**  
**08 to indicate Page 2**

**Figure 1-3: Page Display for 16-Key and 24-Key Multiline Terminals**



Figure 1-4: Page Switching for Data Values shows an example of 10 data values. Values are displayed on two pages.

**16-Key Multiline Terminal**

**(Page 1)**

LK 1	LK 2	LK 3	LK 4
Data 1	Data 2	Data 3	Data 4
LK 5	LK 6	LK 7	LK 8
Data 5	Data 6	Data 7	Data 8

**LCD Display:**  
00 to indicate Page 1

**(Page 2)**

LK 9	LK 10	LK 11	LK 12
Data 9	Data 10		
LK 13	LK 14	LK 15	LK 16

**LCD Display:**  
02 to indicate Page 2

**Figure 1-4:** Page Switching for Data Values

**2.5.5 Station Port Numbering Plan**

Some memory blocks require entering a 2-digit port number. The Xen IPK system supports 48/120 ports. Programming values for entry of Port Assignments are defined below:

Port Assignments	Programming Value
01~99	01~99
100~109	A0~A9
110~119	B0~B9
120	C0

To enter an A, B, or C, press  +1, 2, or 3.

## SECTION 3 SYSTEM DATA LIST

The following table provides a complete list of Memory Blocks that are available in the Xen system. The information is organised by mode, submode, and then numerically by Memory Block number. The Memory Block number and name, the default values, and programming values are provided for each Memory Block.

**Table 1-2: System Data**

### LK 1 System Mode

#### *LK 1 CO Line*

Data No.	Memory Block Name	Default Value	Programming Values
00	Pause Time Selection	3 sec.	1 sec., 3 sec.
01	DP Interdigit Time Selection	Pattern B	Pattern A 10 pps: 650 ms 20 pps: 500 ms Pattern B 10 pps: 800 ms 20 pps: 800 ms
02	Hookflash Time Selection	100 ms.	20 ms., 40 ms., 60 ms., 80 ms., 100 ms., 140 ms., 160 ms., 200 ms. 400 ms., 600 ms., 800 ms., 1 sec., 1.5 sec., 2 sec., 3 sec., 5 sec.
03	Hold Recall Timer Selection (Non Exclusive Hold)	60 sec.	25 sec., 45 sec., 60 sec., 90 sec., 120 sec., 180 sec., 240 sec., No Limit
04	Automatic Redial Time Selection	Calling Time = 30 sec Waiting Time = 60 sec Call Attempts = 2 times	Calling Time: 1~5 sec Waiting Time: 1~100 sec Call Attempts: 1~9 times (3 digit input)
05	Start Timer Selection	10 sec.	2 sec., 10 sec., 20 sec., 30 sec., 40 sec., 50 sec., 60 sec., 70 sec.
06	CO/PBX Incoming Ringing Alarm Time Selection	No Limit	10 sec., 20 sec., 30 sec., No Limit
07	Tie Line Delay Ringing Timer Selection	No Limit	10 sec., 20 sec., 30 sec., No Limit
09	Manual Pause Selection	No	No, Yes
11	System Transfer/Camp-On Selection	Yes	No, Yes
12	Station Transfer/Camp-On Recall Timer Selection	60 sec.	25 sec., 45 sec., 60 sec., 90 sec., 120 sec., 180 sec., 240 sec., No Limit
13	CO Transfer Ring Pattern Selection	Pattern C	Tone Off, Tone On, Patterns A ~ H
14	CO Transfer Ring Tone Selection	Tone A	Tones A ~ H
18	System Speed Dial Restriction by Tenant	Not Restricted	LED On: Not Restricted LED Off: Restricted
19	Line Selection for Automatic Outgoing Calls	TG 01	NON, CO, PBX, TIE TG (01~32), RAB (01~32)
20	DID Digit Length Selection	2 Digits	2, 3, or 4 digits
21	DID Digit Conversion Assignment	Yes	No, Yes

## LK 1 System Mode

### LK 1 CO Line (Continued)

Data No.	Memory Block Name	Default Value	Programming Values
22	DID Digit Conversion Table & DNIS Assignment	Not Specified	Ext. No. (Up to 4 digits)
23	DID Forward Station Number for Busy Station or Undefined Digit	NON	NON, Ext. No.
24	PBX/CTX Access Code Assignment I	0-	Up to six digits (three numeric, three pauses)
25	PBX/CTX Access Code Assignment II	8-	Up to six digits (three numeric, three pauses)
27	Automatic Day/Night Mode Switching Time Assignment	Not Specified	Day/Night Mode Start Time (24 hours)
28	Distinctive Ringing by Telephone or CO Selection	Tel	Tel, CO
29	Private Line Assignment	Not Specified	CO/PBX Line Number, Tel Port Number, up to two lines
30	Route Advance Block Assignment	All Blocks 00 (Not Set)	Priority of Trunk Group Number
32	Automatic Day/Night Mode by Day of Week Selection	(Sunday ~ Saturday) = Pattern 1	Day/Night Automatic Switching Pattern 1, 2
33	Speed Dial Number/Name Display Selection	Dialled Number	Dialled Number, Name
34	Tie Line First Ring Pattern Selection	Pattern 3	Pattern 1, Pattern 2, Pattern 3, Pattern 4, ICM, Voice
35	Speed Dial Buffer Allocation	100 Memories	100 Memories, 1,000 Memories
37	Trunk Queuing Timeout Selection	10 sec.	10 sec., 20 sec., 30 sec., 60 sec.
46	Access Code (1-Digit) Assignment	Refer to Access Code (1-Digit) Assignment on page 1-76.	
47	Access Code (2-Digit) Assignment	Refer to Access Code (2-Digit) Assignment on page 1-81.	
48	Access Code (3-Digit) Assignment	All Dial 000 (Not Used)	Refer to Access Code (1-Digit) Assignment on page 1-76.
49	Networking Trunk Group/Route Advance Assignment	Not Specified	Trunk Group 01 ~ 32 or Route Advance Block 01 ~ 16
50	CO/PBX Outgoing Digit Add Assignment	Not Specified	10 digits max. (On 9, *, #)
51	CO Line Ringing Pattern Selection	RIng Pattern G	Pattern A ~ H, Nil
52	PBX Line Ringing Pattern Selection	Ring Pattern B	Pattern A ~ H, Nil
53	Tie Line Delay Ring Pattern Selection	Ring Pattern C	Pattern A ~ H, Nil
54	Automated Attendant Transfer Ring Pattern	Ring Pattern C	Pattern A ~ H, Nil
55	DID Line Ringing Pattern Selection	Ring Pattern C	Pattern A ~ H, Nil
57	CO/PBX Prepause Timer Selection	3 sec.	None, 1 sec. ~ 13 sec.
59	Synchronous Ringing Selection	Yes	Yes, No
60	8-Digit Matching Table Assignment	Refer to 8-Digit Matching Table Assignment on page 1-98.	

## LK 1 System Mode

### LK 1 CO Line (Continued)

Data No.	Memory Block Name	Default Value	Programming Values
61	8-Digit Matching Table to Class Assignment	Refer to 8-Digit Matching Table Assignment on page 1-98.	
62	System Speed Dial Override by Class Selection	Override (YS)	No = No Override Yes = Override
63	Hold Recall Time Selection (Exclusive)	1 min.	0.5 min., 1 min., 1.5 min., 2 min., 3 min., 5 min., 8 min., No Limit
64	Attendant Add-On Console Transfer/ Camp-On Recall Timer Selection	1 min.	0.5 min., 1 min., 1.5 min., 2 min., 3 min., 5 min., 8 min., 10 min.
65	Code Restriction Class Allow/ Deny Selection	Class 01 = Deny Class 02 ~ 14 Allow (YS)	Allow, Deny
66	8-Digit Matching Table to Normal Dial Assignment	Tables 00 ~ 15 = Used Table 15 = Unused	Used, Unused
67	OCC Table Assignment	Not Specified	0~9, *, X, P, N
68	8-Digit Matching Table to OCC Table Assignment	Table 00~15 = All Not Used Table 16 = 00~14 Not Used, 15 Used	8-digit Matching Table Used or Not Used
69	Tie Line Code Restriction Assignment	(YS) Restriction	No = No Restriction Yes = Restriction
70	Code Restriction Class Assignment when Lockout is Set	Class 01	Restriction Class: 00 ~ 15
71	First Delay Announcement Start Time Selection	20 sec.	0 sec., 10 sec., 20 sec., 30 sec., 40 sec., 50 sec., 60 sec.
72	First Delay Announcement Repeat Selection	1 Time	1, 2, 3, 4, 5, 6, 7, 8 times
73	First to Second Delay Announcement Interval Time Selection	20 sec.	0 sec., 10 sec., 20 sec., 30 sec., 40 sec., 50 sec., 60 sec., No Limit
74	Second Delay Announcement Repeat Selection	1 Time	1, 2, 3, 4, 5, 6, 7, 8 times
75	Second Delay Announcement Repeat Interval Time Selection	20 sec.	0 sec., 10 sec., 20 sec., 30 sec., 40 sec., 50 sec., 60 sec., No Limit
76	Barge-In Alert Tone Assignment		
77	Delayed Ringing Timer Assignment (CO)	15 sec.	00 ~ 99
78	Caller ID Display Assignment for System Mode	Not Specified	Combination No = 1~5 Selectable Tel No = 1~20
79	BGM Port Assignment	Not Specified	CO No. (01~64)
80	ISDN DTMF Duration/Interdigit Time Selection	DD/IT = 100 ms/70 ms	DD/IT = 70/60 ms, 100/70 ms, 400/100 ms, 600/100 ms, 900/200 ms
81	ISDN Dial Interval Timer	8 sec.	2s, 4s, 8s, 16s, 32s
82	Code Restriction Bypass Table	Not Specified	10 Digits (0~9) x 10 Tables
85	ISDN Stimulus Method Selection		

## LK 1 System Mode

### LK 1 CO Line (Continued)

Data No.	Memory Block Name	Default Value	Programming Values
86	Call Monitoring Alert Assignment		

## LK 1 System Mode

### LK 2 ICM

Data No.	Memory Block Name	Default Value	Programming Values
00	Internal Paging Timeout Selection	90 sec.	90 sec., 120 sec., No Limit
01	Intercom Call Voice/Tone Signal Selection	Tone	Tone, Voice
02	Automatic Callback Release Timer Selection	30 min.	30 sec., 1 min., 2 min., 3 min., 5 min., 10 min., 20 min., 30 min.
03	2-, 3-, or 4-Digit Station Number Selection	3-digit	2-digit, 3-digit, 4-digit
04	Call Arrival Key Block Assignment	Not specified	Tel Port No. Blocks (4 Ch Assign)
08	Specified Station Access Code Assignment	00 = 01 01 ~ 23 Not Set	Tel. Port Number
09~18	Customised Message 1~10 Assignment	09 = Don't Disturb 10 = Meeting 11 = Business Trip 12 = Not In 13 = With Guest 14 = Out of Office 15~18 = Not Specified	Maximum of 13 characters.  (Refer to <i>Section 7 Character Code Tables on page 1-541</i> for a list of characters.)
19	Intercom Ring Pattern Selection	Pattern B	Tone Off Tone On Patterns A~H
20	Intercom Ring Tone Selection	Tone A	Tones A~H
21	PHS Telephone Assignment	Not specified	NON, PHS, Tel No., Tel No.
22	Call Forward No Answer Timer Selection	8 sec.	4 sec., 8 sec., 12 sec., 18 sec., 24 sec., 30 sec., 60 sec.
23	System Call Park Recall Time Selection	1 min.	0.5 min., 1.0 min., 1.5 min., 2.0 min., 3.0 min., 5.0 min., 8.0 min., 10.0 min.
24	Intercom Feature Access Code Assignment	<i>Refer to Intercom Feature Access Code Assignment on page 1-146.</i>	
25	Internal Paging Alert Tone Selection	Tone YS	Tone YS Tone No
26	Delayed Ringing Timer Assignment (ICM)	10 sec.	00~99
28	PS Out of Area Tone Selection	BT	BT (Busy), RBT (Ring Back)
30	PS Out of Area Timer Selection (BSU only)	12 sec.	00~99 sec.

**LK 1 System Mode***LK 2 ICM (Continued)*

Data No.	Memory Block Name	Default Value	Programming Values
31	Call Pickup Group - Direct	All Blank	0~9 groups. 30 Tel per group max.

**LK 1 System Mode***LK 3 SLT*

Data No.	Memory Block Name	Default Value	Programming Values
01	Bounce Protect Time Selection	300 ms.	Page 1:0 ms., 100 ms., 200 ms., 300 ms., 400 ms., 500 ms., 600 ms., 700 ms.  Page 2:800 ms. 900 ms., 1000 ms., 1100 ms., 1200 ms., 1300 ms., 1400 ms., 1500 ms.
02	SLT Hookflash Signal Selection	Hold	Hold Flash
03	First Digit PBR Release Timer Selection	10 sec.	10 sec., 20 sec., 30 sec., 40 sec., 50 sec., 60 sec.
04	Dial 1 (DP) Hookflash Selection	Yes	Yes, No
05	Hookflash Start Time Selection	40 ms.	40 ms., 90 ms., 140 ms., 190 ms. 240 ms., 290 ms., 340 ms., 390 ms., 440 ms., 490 ms. 540 ms., 590 ms., 640 ms., 690 ms., 740 ms., 790 ms.
06	Hookflash End Time Selection	HST + 100 ms.	Refer to <i>Hookflash End Time Selection on page 1-159.</i>
07	Voice Mail Digit Add Assignment	All Blank	0~9, *, # (up to 4 digits)
08	Voice Mail DTMF Delay Timer Selection	1 sec.	0 sec., 1 sec., 2 sec., 3 sec., 4 sec., 5 sec., 6 sec., 8 sec.
09	Voice Mail Disconnect Time Selection	1.5 sec.	0.5 sec., 1 sec., 1.5 sec., 2 sec., 3 sec., 3.5 sec.
10	Voice Mail DTMF Duration/Interdigit Time Selection	110/80 ms.	60/70 ms., 110/80 ms., 410/100 ms., 610/100 ms., 810/190 ms.
11	SLT/PHS Talk Start Timer		

## LK 1 System Mode

### *LK 4 Transfer/Automated Attendant (A.A.)*

Data No.	Memory Block Name	Default Value	Programming Values
00	Tandem Transfer Automatic Disconnect Timer Selection	1 hr.	30 min., 1 hr., 2 hr., 3 hr.
01	Automated Attendant First Digit PBR Release Timer Selection	10 sec.	5 sec., 10 sec., 20 sec., 30 sec., 40 sec., 50 sec., 60 sec.
02	Automated Attendant Transfer Delayed Ringing Time Selection	No Limit	10 sec., 20 sec., 30 sec., No Limit
03	Automated Attendant No Answer Disconnect Time Selection	2 min.	1 min., 2 min., 3 min., 4 min.
04	Tandem Transfer SMDR Print Extension Assignment	Tel No. 999	2-digit = 00 ~99 3-digit = 000 ~999 4-digit = 0000 ~9999
05	Automatic Tandem Trunk by Night Mode Selection	No	Yes, No
08	Automated Attendant PBR Timeout Response Selection	Normal Call	Normal Call, Release
09	Automated Attendant PBR Start Time Selection	FR	FR = Same Time as Greeting AF = After Greeting
11	Automated Attendant Message Day Night Mode Selection	No	Yes, No
12	Automated Attendant Message to Tenant Assignment	All Automated Attendant Messages: Tenant Number 00	LK01~08 Assigned to CO/PBX Lines 01~08
13	Automated Attendant Answer Delay Time Assignment	4 sec.	00~99 sec., per MSG 1~8
14	Automated Attendant Message Access Code (1-Digit) Assignment	<i>Refer to Automated Attendant Message Access Code (1-Digit) Assignment on page 1-179.</i>	
15	Automated Attendant Message Access Code (2-Digit) Assignment	<i>Refer to Automated Attendant Message Access Code (2-Digit) Assignment on page 1-182.</i>	
16	Automated Attendant Message Repeat Selection	All Messages One Time	1, 2, 3, 4, 5, 6, 7, 8 times
17	Automated Attendant Delay Announcement Hold Tone Selection	RBT	RBT (Ringback) MOH (Music on Hold)
18	Automated Attendant Delay Announcement Assignment	Not specified	None, MSG 1, MSG 2, MSG 3, MSG 4, MSG 5, MSG 6, MSG 7, MSG 8
19	Automated Attendant 1st to 2nd Delay Announcement Interval Time Selection	4 minutes	0 sec., 10 sec., 20 sec., 30 sec., 1 min., 2 min., 3 min., 4 min., 5 min., 10 min., 20 min.
20	Automated Attendant Delay Announcement Disconnect Time Selection	30 seconds	0 sec., 10 sec., 20 sec., 30 sec., 1 min., 2 min., 3 min., 4 min., 5 min., 10 min., 20 min.

**LK 1 System Mode***LK 4 Transfer/Automated Attendant (A.A.) (Continued)*

Data No.	Memory Block Name	Default Value	Programming Values
21	Automated Attendant Extension Number Assignment	Not Specified	Tel No. (Up to 4 digits) phantom number only (for each AA message 1~8)
22	Automated Attendant Direct Extension Ring or Ring Assignment	Not Specified	Tel No. (Up to 4 digits) real extension number or CAR (for each AA message 1~8)

**LK 1 System Mode***LK 5 SMDR/LCR*

Data No.	Memory Block Name	Default Value	Programming Values
02	SMDR Print Format	All	All, Mask Digits
13	Printer Connected Selection	No	No, PC, Printer
14	Printer Line Feed Control Selection	No	Yes, No
23	Outgoing Mode Selection		
25	SMDR Valid Call Timer Assignment	00 = 0 sec.	00~99 sec. (input value) x 10 sec.
26	SMDR Incoming/Outgoing Print Selection	All	All, Outgoing, Incoming

**LK 1 System Mode***LK 6 DSS*

Data No.	Memory Block Name	Default Value	Programming Values
00	Attendant Add-On Console to Telephone Port Assignment	<i>Refer to Attendant Add-On Console to Telephone Port Assignment on page 1-197.</i>	
03	DSS Call Voice/Tone Signal Selection	Voice	Tone, Voice
05	Attendant Add-On Console Key Selection	<i>Refer to Attendant Add-On Console Key Selection on page 1-199.</i>	
08	Attendant Transfer Selection During Live Record	Yes	No, Yes



## LK 1 System Mode

### LK 7 ESP

Data No.	Memory Block Name	Default Value	Programming Values
00	Doorphone Assignment	No	No (Not Assign)/Yes (Assign)
01	Doorphone Display Time Selection	10 sec.	10 sec., 30 sec., 60 sec., 90 sec.
02	External Speaker Connection Selection	All Yes	No, Yes per Speakers (A~C)
03	External Paging Alert Tone Selection	Yes	Yes, No
04	Doorphone Ringing Pattern Selection	On	Off, On, A~H
05	Doorphone Ringing Frequency Selection	C	A~H
06	External Paging Timeout Selection	5.0 min.	0.5 min., 1 min., 1.5 min., 2 min., 3 min., 5 min., 8 min., No Limit
07	External Ring Relay Cycle Selection	Pattern 3	Pattern 1, 2, 3, 4, 5, 6, Continuous
08	External Speaker Chime Selection	Pre-Tone	Pre-Tone/Chime (Start)/ Chime (Both)
09	External Speaker Chime Start Time Selection	700 ms.	0~1500 msec = (Input value) x 100 msec

## LK 1 System Mode

### LK 8 PBR/Miscellaneous

Data No.	Memory Block Name	Default Value	Programming Values
01	SLT or Automated Attendant/DISA to PBR Selection	Off	Off = Single Line Telephone On = Automated Attendant/DISA
02	PBR Receive Level Assignment for Automated Attendant/DISA	-46.0 dBm	-33 dBm ~ -48 dBm @ iDB Step
04	Time Display (12h/24h) Selection	12-hour Display	12-hour Display 24-hour Display
07	Class of Service (Attendant) Feature Selection 1	<i>Refer to Class of Service (Attendant) Feature Selection 1 on page 1-220.</i>	
08	Class of Service (Station) Feature Selection 2	<i>Refer to Class of Service (Station) Feature Selection 2 on page 1-223.</i>	
09	Music on Hold Pattern Selection	Pattern A	Pattern A, Pattern B
10	PBR Interdigit Release Timer Selection	7 sec.	3 sec., 4 sec., 5 sec., 6 sec., 7 sec., 8 sec., 9 sec., 10 sec.
11	System Refresh Timer Assignment	4 hr.	No Refresh, 4 hr., 8 hr., 12 hr., 24 hr.
12	VRS Message Recording Time Selection	15 sec./16 Messages	15 sec./16 Messages 30 sec./8 Messages 60 sec./4 Messages 120 sec./2 Messages

## LK 1 System Mode

### LK 8 PBR/Miscellaneous (Continued)

Data No.	Memory Block Name	Default Value	Programming Values
13	VRS Message Function Assignment	No Message	No Message Voice Prompt 1~2 1st and 2nd Delay Announce Day Mode A.A. 1~8 Night Mode A.A. 1~8 Weekend Mode A.A. 1~8
15	Tone Assignment	Tone A	Refer to <i>Tone Assignment on page 1-234.</i>
16	Voice Prompt to Tone Assignment	DT = VP1 CWT = VP2	Assign Voice Prompt 1 or 2 to Dial Tone and Call Waiting Tone
17	PC Programming Password Assignment	Class 1 All Blank	Class 1: ID No. Assign Up to 8 digits
18	Site Name Assignment	Blank	Up to 8 Digit
25	ACD/UCD Group Agent Assignment	Not Specified	Tel No. = Up to 32 Agents (ACD/UCD Group No 1~4)
26	Voice Mail Quick Transfer Master Hunt Number	Not Specified	Station No. 2 Digit = 00~99 3 Digit = 000~999 4 Digit = 0000~9999
27	Forced Account Code Length Assignment	4 Digits	1~13 Digits
29	SCD (Simplified Call Distribution) Pilot Number Assignment	Not Specified	Tel No. (up to 4 digit) for SCD Group No. 1~4
30	SCD Group Agent Assignment	Not Specified	Up to 32 Agents Divided (SCD Group No. 1~4)
31	Hold Tone Source Selection	Internal	Internal or External
32	Hold Internal Tone Volume Selection	0 dB	0 dB, -6 dB
33	Master Clock Selection	Cabinet No. = 0 (No Assign)	Cabinet: 0~3 Slot: 1~8
35	COM Port Baud Rate Setting Assignment	COM 1: 38.4 Kbps COM 2: 4.8 Kbps COM 3: 4.8 Kbps COM 4: 9.6 Kbps	COM 1~4: 4.8 Kbps, 9.6 Kbps, 19.2 Kbps, 38.4 Kbps
36	COM Port Parity/Stop Bit Setting Assignment	COM 1~4: None/1	COM 1~4: None/1, None/2, Even/1, Odd/1
37	General Purpose Relay Assignment	No	Yes = Assigned, No = Not Assigned
38	Modem Port for Remote Programming Assignment	Not Specified	Station No. 2 Digit = 00~99 3 Digit = 000~999 4 Digit = 0000~9999
40	ACD Hunt Timer	10 sec.	10 sec., 20 sec., 30 sec., 60 sec., 120 sec., 240 sec., No Limit.
47	CAR for Voice Mail Message Notice Assignment	Not Specified	Any unused CAR

### LK 1 System Mode

#### *LK 8 PBR/Miscellaneous (Continued)*

Data No.	Memory Block Name	Default Value	Programming Values
48	New AA-Info Yes/No Selection		

### LK 1 System Mode

#### *LK 9 DISA*

Data No.	Memory Block Name	Default Value	Programming Values
00	DISA/ID Code Assignment	<i>Refer to DISA/ID Code Assignment on page 1-255.</i>	
02	DISA/ID Password Effect/Invalid Selection	DISA Password Effect (Yes)	DISA Password Invalid (No) DISA Password Effect (Yes)
03	ID Restriction Class Assignment (Day Mode)		
04	ID Restriction Class Assignment (Night Mode)		

### LK 1 System Mode

#### *LK 11 ???*

Data No.	Memory Block Name	Default Value	Programming Values
00	T1 Signal Format Selection		
01	Clear Channel Selection		
02	Line Length Selection		
03	IP K-CCIS Selection		
05	TI Channel Selection		
06	Signalling Selection		
07	DTI Trunk Type Assignment		
08	Digits Delete for TI ANI Assignment		

## LK 1 System Mode

### LK 12 ACD/UCD

Data No.	Memory Block Name	Default Value	Programming Values
00	ACD/UCD Group Pilot Number Assignment	Not Specified	Tel No. (Up to 4 digits) (for each ACD/UCD Group No. 1~4)
01	ACD/UCD Group Overflow Destination Assignment	Not Specified	Tel No. (Up to 4 digits) (for each ACD/UCD Group No. 1~4)
02	ACD/UCD Overflow Timer Selection	60 sec.	∞, 10 sec., 20 sec., 30 sec., 60 sec., 120 sec., 180 sec., 240 sec. (for each ACD/UCD Group No. 1~4)

## LK 1 System Mode

### LK 13 PRI/ISDN

Data No.	Memory Block Name	Default Value	Programming Values
00	PRI Channel Assignment	<i>Refer to PRI Channel Assignment on page 1-275.</i>	0, 4, 8, 12, 16, 20, 24, 28, 32
04	PRT B Channel Outgoing Priority Selection		
05	PRT B Channel-to-Trunk Group Assignment		

## LK 1 System Mode

### LK 14 Automatic Route Selection

Data No.	Memory Block Name	Default Value	Programming Values
00	ACR Feature Allow/Deny Selection	No	Yes (Allow), No (Deny)
01	ACR Dialling Assignment	None	Table No. 1~4 Dial No. 01~C8 Setting Data (8 digit Max) including 0~9), *, #, X (0~9), *, #), P (0 or 1), or N (2~9)
02	ACR Dialed Number Dial Allow/Deny Selection	Yes	Yes (Allow), No (Deny)
03	ACR Route Table Number Assignment	00	Table No. 1~4 Dial No. 01~C8 Routes 01~32
04	ACR Trunk Group to Route Number Assignment	Normal	Normal, TKGP 01~32, ICM

## LK 1 System Mode (Continued)

### *LK 14 Automatic Route Selection*

Data No.	Memory Block Name	Default Value	Programming Values
05	ACR Digit Delete Assignment	00	00~10 Digits
06	ACR Digit Add Assignment	Not specified	Up to 10 digits using 0~9, *, #
07	ACR Max Digit Assignment		

## LK 1 System Mode

### *LK 15 ???*

Data No.	Memory Block Name	Default Value	Programming Values
00	K-CCIS Main/Remote Office Selection		
02	Common Signal Channel Assignment		
03	Originating Point Code Assignment		
04	Destination Point Code Assignment		
05	Destination Point Code Transfer Assignment		
06	Originating Office Code Number Assignment		
07	K-CCIS Message Response Timeout Assignment		
08	Link Reconnect Allow/Deny Selection		
09	K-CCIS Maximum Call Forwarding Hop Assignment		
10	Calling Name Display Allow/Deny Selection		
11	Centralised Billing Allow/Deny Selection		
12	Centralised Billing – Point Code of Centre Office Assignment		
13	Centralised Day/Night Switching for Remote Office Assignment		
14	Centralised Day/Night Switching for Main Office Assignment		
15	Centralised BLF Send Point Code Assignment		
16	Centralised BLF Send Extension Number Assignment		
17	Centralised BLF Send Time Assignment		

## LK 1 System Mode (Continued)

### LK 15 ???

Data No.	Memory Block Name	Default Value	Programming Values
18	Centralised BLF Receive Extension Number Assignment		

## LK 2 Tenant Mode

Data No.	Memory Block Name	Default Value	Programming Values
01	Trunk to Tenant Assignment	<i>Refer to Trunk to Tenant Assignment on page 1-329.</i>	
05	Line Key Selection	Telephone Mode	Telephone Mode Tenant-Wide Mode
06	Line Key Selection for Tenant Mode	<i>Refer to Line Key Selection for Tenant Mode on page 1-332.</i>	
07	System Speed Dial Display Assignment	All Speed Dial Confirmation Allowed	No (Not Allowed) Yes (Allowed)
08	ECR Relay to Tenant Assignment	All Tenants - No Assignment	Assigned or Not Assigned - Ext Tone Relay 1~4 and Night Chime per Tenant
09	Dial-In Tenant Incoming Limit Assignment	No Limit = 0	00~47 tenants (each can be assigned a limit dependant on max. lines available)

## LK 3 CO/PBX Line Mode

Data No.	Memory Block Name	Default Value	Programming Values
00	Trunk Name/Number Assignment	All Trunks = Blank (ASCII Entry)	Maximum of 13 characters/numbers
02	ISDN Dial-Out Sending Selection	Out and In	Out and In In
03	Trunk-to-Trunk Group Assignment	<i>Refer to Trunk-to-Trunk Group Assignment on page 1-341.</i>	
04	Trunk-to-Trunk Transfer Yes/No Selection	Yes	No, Yes
05	Trunk Incoming Answer Mode Selection	Normal	Normal Automatic Trunk-to-Trunk Transfer Automated Attendant/DISA
06	Automatic Tandem Trunk Assignment	Not Specified	CO 01~64
07	CO/PBX Ringing Variation Selection	Medium (M)	Low (L) Medium (M) High (H)
11	CO External Source Selection	Not Specified	Trunks 1~64
12	CO Hold Melody Selection (CO)	Not Specified	Trunks 1~64

### LK 3 CO/PBX Line Mode (Continued)

Data No.	Memory Block Name	Default Value	Programming Values
14	Tie/DID Line Type Assignment	Immediate	Second Dial Tone Immediate Delayed Wink Start
15	Trunk DTMF Duration/Interdigit Selection	60 ms/80 ms	60 ms. /70 ms. 60 ms. /80 ms. 110 ms. /80 ms. 160 ms. /80 ms. 210 ms. /80 ms. 410 ms. /100 ms. 610 ms. /100 ms. 810 ms. /190 ms.
16	Tie Line Prepause Time Selection	0 sec.	0 sec., 0.5 sec., 1 sec., 1.5 sec., 2 sec., 3 sec., 4 sec., 5 sec., 6 sec., 7 sec., 8 sec., 9 sec., 10 sec., 11 sec., 12 sec., 13 sec.
17	Tie Line Answer Detect Time Selection	390 ms	0 ms., 130 ms., 260 ms., 390 ms., 520 ms., 650 ms., 780 ms., 910 ms., 1040 ms., 1170 ms., 1300 ms., 1430 ms., 1560 ms., 1690 ms., 1820 ms., 1950 ms.
18	Tie Line Release Detect Time Selection	260 ms	0 ms., 130 ms., 260 ms., 390 ms., 520 ms., 650 ms., 780 ms., 910 ms., 1040 ms., 1170 ms., 1300 ms., 1430 ms., 1560 ms., 1690 ms., 1820 ms., 1950 ms
19	Tie Line/CO/PBX Incoming Signal Detect Time Selection	<i>Refer to Tie Line/CO/PBX Incoming Signal Detect Time Selection on page I-356.</i>	
20	Tie Line Loop Off-Guard Time Selection	2 sec.	0 sec., 0.5 sec., 1 sec., 1.5 sec., 2 sec., 3 sec., 4 sec., 5 sec., 6 sec., 7 sec., 8 sec., 9 sec., 10 sec., 11 sec., 12 sec., 13 sec.
21	Tie Line Length of Wink Signal Selection	180 ms.	30 ms., 60 ms., 90 ms., 120 ms., 150 ms., 180 ms., 210 ms., 240 ms., 270 ms., 300 ms., 330 ms., 360 ms., 390 ms., 420 ms., 450 ms., 480 ms.
22	Tie Line Length of Delay Signal Selection	300 ms.	0 ms., 300 ms., 600 ms., 900 ms., 1200 ms., 1500ms., 1800 ms., 2100 ms., 2400 ms., 2700 ms., 3000 ms., 3300 ms., 3600 ms., 3900 ms., 4200 ms., 4500 ms.
24	Tie Line Incoming Interdigit Timeout Selection	11 sec.	1 sec., 2 sec., 3 sec., 4 sec., 5 sec., 6 sec., 7 sec., 8 sec., 9 sec., 10 sec., 11 sec., 12 sec., 13 sec., 14 sec., 15 sec., No Limit
25	Tie Line Wink/Delay Signal Detect Timeout Selection	7 sec.	1 sec., 2 sec., 3 sec., 4 sec., 5 sec., 6 sec., 7 sec., 8 sec., 9 sec., 10 sec., 11 sec., 12 sec., 13 sec., 14 sec., 15 sec., No Limit
27	Tie Line Dial Tone Selection	No	Yes, No
28	Tie Line Reorder Tone Selection	Sending (Yes)	Sending (Yes) Not Sending (No)

### LK 3 CO/PBX Line Mode (Continued)

Data No.	Memory Block Name	Default Value	Programming Values
29	Trunk Internal Transmit Pad Selection	2 dB	2 dB, 4 dB, 6 dB, 8 dB, 12 dB, 16 dB, 3 dB, -3 dB, 0 dB
30	Trunk Internal Receive Pad Selection	4 dB	2 dB, 4 dB, 6 dB, 8 dB, 12 dB, 16 dB, 3 dB, -3 dB, 0 dB
31	Trunk External Transmit Pad Selection	0 dB	2 dB, 4 dB, 6 dB, 8 dB, 12 dB, 16 dB, 3 dB, -3 dB, 0 dB
32	Trunk External Receive Pad Selection	0 dB	2 dB, 4 dB, 6 dB, 8 dB, 12 dB, 16 dB, 3 dB, -3 dB, 0 dB
33	Disconnect Recognition Time Selection	2.0 sec.	0 sec., .2 sec., .3 sec., .5 sec., .7 sec., .9 sec., 1.0 sec., 1.2 sec., 1.4 sec., 1.5 sec., 1.7 sec., 1.9 sec., 2.0 sec., 2.2 sec., 2.4 sec., 2.6 sec.
38	Automated Attendant Message to Trunk Selection	Message 1	Message 1~8
39	Automatic Release Selection	Yes	Yes, No
41	ACD/UCD Delay Announcement Assignment	<i>Refer to ACD/UCD Delay Announcement Assignment on page 1-380.</i>	
42	DIT Assignment	No Assignment	Station No.
43	ANA Assignment	No Assignment	Station No.
44	Caller ID Display Assignment for CO/PBX Line	Not Specified	Telephone Port 01~96
45	Live Recording Trunk Selection	No	No = No Live Recording Yes = Live Recording
52	ISDN Trunk Directory Number Assignment	Not Specified	Up to 13 digit per a CO/PBX Port No.
53	Caller Name Indication Selection	Trunk Name	No Indication, Caller No. Indication, Name Indication (by SPD), Trunk Name
57	ISDN Dial-Out Sending Selection		
59	Automated Attendant Function Selection	Normal	Normal, Delay Announcement
61	DIT Delay Answer Timer Selection	Trunks (1-64) = 0 sec.	0s, 5s, 10s, 20s, 30s, 40s, 50s, 60s
62	DIT Tenant Assignment	All CO/PBX Lines are set to tenant 00	Trunk (1-64) can be set to a tenant (00-47)
63	DIT Holiday Mode Enable	Holiday DIT = YES	NO, YES
64	DIT Night Mode Delay Answer Enable	Night DIT = NO	NO, YES
65	Hold Tone Automated Attendant Selection	All CO/PBX lines are set to "NON"	NON, MSG1, MSG2, MSG3, MSG4, MSG5, MSG6, MSG7, MSG8
67	CO Line Ringing Pattern Selection for CO/PBX Line Mode	— = NON	Pattern A~H
70	CIC Number Assignment		
71	Caller Name Display Assignment		



### LK 3 CO/PBX Line Mode (Continued)

Data No.	Memory Block Name	Default Value	Programming Values
72	ISDN BRT Connection Configuration		
90	Polarity Reverse Selection	CO/PBX/DID/TLI = No BRI/PRI = Yes	Yes, No
91	Trunk Type Selection	CO	CO PBX Tie DID CTX Assume 9
92	Trunk (Installed, DP/DTMF) Selection	MF	Nil DP 10 pps DP 20 pps DTMF

### LK 4 Telephone Mode

Data No.	Memory Block Name	Default Value	Programming Values
01	CO/PBX Ring Assignment (Day Mode)	<i>Refer to CO/PBX Ring Assignment (Day Mode) on page 1-405.</i>	No Ring Immediate Ring Delayed Ring
02	CO/PBX Ring Assignment (Night Mode)	<i>Refer to CO/PBX Ring Assignment (Night Mode) on page 1-407.</i>	No Ring Immediate Ring Delayed Ring
03	Doorphone Chime Assignment (Day Mode)	Station Port 01 and 02 Chime (All Four Doorphones)	Station Port 01~120 Chime on a per Doorphone Basis
04	Doorphone Chime Assignment (Night Mode)	Station Port 01 and 02 Chime (All Four Doorphones)	Station Port 01~120 Chime on a per Doorphone Basis
05	Automatic Outgoing CO/PBX Line Selection	Tel Port (01-CO) = All Trunks (01-64) set to "YES"	NO, YES
07	Code Restriction Class Assignment (Day Mode)	All Stations Class 00	Class 00~15 per Station
08	Code Restriction Class Assignment (Night Mode)	All Stations Class 00	Class 00~15 per Station
09	Telephone to Tenant Assignment	All Telephones Tenant 00	Tenant Number 00~47
10	Station Number Assignment	<i>Refer to Station Number Assignment on page 1-417.</i>	
11	Ringing Line Preference Selection	Yes	No, Yes
12	Line Key Selection for Telephone Mode	<i>Refer to Line Key Selection for Telephone Mode on page 1-419.</i>	
13	CO/PBX Busy Forward Station Assignment	Not Specified	Tel Port 01~96
14	Intercom Master Hunt Number Selection	No	No, Yes

## LK 4 Telephone Mode (Continued)

Data No.	Memory Block Name	Default Value	Programming Values
15	Intercom Master Hunt Number Forward Assignment	All Telephones Not Specified	Station Number (2, 3, 4 Digit)
17	Station to Class of Service Feature Assignment	<i>Refer to Station to Class of Service Feature Assignment on page 1-424.</i>	
18	Station Name Assignment	All Blank	Up to six digits (characters)
19	Trunk Outgoing Restriction	Not Restricted	No = Not Restricted Yes = Restricted
23	Prime Line/Hot Line Assignment	Not Specified	Up to 10 digits (0~9, *, #)
24	SLT Hookflash Assignment	Hold	Hold Disconnect
26	DISA/ID Number Station Assignment	<i>Refer to DISA/ID Number Station Assignment on page 1-430.</i>	
27	ID Outgoing Restriction Selection		
28	Multilingual LCD Indication Selection	English	English Japanese
29	HFU Selection	Yes	No, Yes
30	Hold/Transfer Recall Display Selection	Yes	Yes, No
31	Receiving Internal/All Call Page Selection	Yes	Yes, No
32	Trunk Digit Restriction	00 (No Limit)	00 (No Limit), 01~99 Digit
35	Voice Mail/SLT Selection	No	Yes, No
36	Voice Prompt Selection	No	No, Yes
37	Extension Line Key Ring Assignment (Day Mode)	All Telephones: No Ring	No Ring Immediate Ring Delayed Ring
38	Extension Line Key Ring Assignment (Night Mode)	All Telephones: No Ring	No Ring Immediate Ring Delayed Ring
39	APR Ring Mode Assignment	Station Number (Only)	No Ring Station Number (Only) All Ring
40	LCR Class Selection	Class 0	Classes 0~4
41	SIE/CAR Ringing Line Preference Selection	Yes	Yes, No
42	Call Forward-Busy Immediately/Delay Selection	No	No = Immediately Yes = Delay
43	Station to Call Appearance Block Assignment	All Stations Assigned Call Appearance Block 00	Call Appearance Block 00~47
44	Caller ID/Presel Dial Outgoing CO Selection	Not Specified	Trunk Access Code 5 Digit
46	Live Record Auto Delete	No	Yes (Delete) No (Don't Delete)

## LK 4 Telephone Mode (Continued)

Data No.	Memory Block Name	Default Value	Programming Values
47	ISDN Directory Number Selection		
49	Caller ID Display for CAR Key	Not Specified	Tel Port No. 01~120
50	Multiline Terminal Type Selection	16 Button Type	16 Button Type 24 Button Type 24A Button Type
51	Off-Hook Ringing Selection	Yes	Yes, No
52	CO/PBX Answer Key Operation without Ringing Assignment (Day Mode)	YES (ALL Ports)	YES/NO
53	CO/PBX Answer Key Operation with-out Ringing Assignment (Night Mode)	NO (ALL Ports)	YES/NO
55	CO Ringing Pattern Selection for Telephone Mode	— = NON (All Ports)	PATTERN: NON, A~H
56	SMDR Telephone Print Selection	YES (ALL Ports)	YES, NO
57	CO Line Ringing Pattern by Telephone or CO Selection	CO	CO, TEL
58	Automated Attendant DID Assignment	NON	NON, AA1, AA2, AA3, AA4, AA5, AA6, AA7, AA8
59	APR Hookflash Selection		
61	Station Name/Number Display Selection		
62	ISDN Extension-based Caller ID Assignment		
64	Timer Class Assignment for Telephone Mode Selection	Tel 01~120, Class 15	00 (Class 0) - 15 (Class 15)
65	Code Restriction Class Assignment CFVA Restricted Tel/Night Mode	Tel 01~120, Class 15	00 (Class 0) - 15 (Class 15)
66	ACD Plus Hold Tone Selection	MOH	MOH, RBT
67	IP Station Number Assignment		
68	LCD Line Key – Name Assignment		
90	SLT Data Line Security Assignment	SLT Normal	SLT Normal, SLT Data
91	Telephone Ringing Variation Selection	Medium (M)	Low (L) Medium (M) High (H)
92	Receiving Volume Selection	Down	Down, Up
93	Internal Zone Paging Selection	No	No Zone A Zone B Zone C
94	3-Minute Alarm Selection	No	No, Yes
95	DTMF/DP SLT Type Selection	DTMF	DP, DTMF

## LK 5 Trunk Group Mode

Data No.	Memory Block Name	Default Value	Programming Values
00	Digit Add/Del for Tie Line Networking	No Add and Delete = 000	Delete up to two digits Add up to two digits
01	Tie Line Networking Tandem Connection Assignment	All Trunk Groups = Yes	On = Yes (Enabled) Off = No (Disabled)
02	8-Digit Matching Table to Trunk Group Assignment	Enabled	On = Use (Enabled) Off = Not Used (Disabled)
03	OCC Table to Trunk Group Assignment	Use All Tables	On - Use (Enabled) Off = Not Used (Disabled)
04	LCR Class to Trunk Group Selection		
05	Common Signalling Channel Route Assignment		
06	Trunk Group Outgoing Priority Selection		

## LK 6 Copy Mode

Data No.	Memory Block Name	Default Value	Programming Values
2	Tenant Mode Copy Assignment	N/A	Tenant 00~47
3	CO Line Mode Copy Assignment	N/A	Tenant 01~64
4	Telephone Mode Copy Assignment	N/A	Tenant 01~120
5	Trunk Group Mode Copy Assignment	N/A	Tenant 01~32

## LK 7 ETU Mode

Data No.	Memory Block Name	Default Value	Programming Values
1	Card Interface Slot Assignment	<i>Refer to Card Interface Slot Assignment on page 1-501..</i>	
2	Telephone Type Assignment	Telephone	NON Telephone DSS Console SLT Adapter Digital Voice Mail
3-00	MIF (ACD) Assignment	No Assignment (00)	00~02 (MIFA PKG Assigned Port No.
3-01	MIF (LCR) Assignment	No Assignment (00)	00~02 (MIFM PKG Assigned Port No.
3-02	MIF (SMDR) Assignment	No Assignment (00)	00~02 (MIFM PKG Assigned Port No.
3-03	MIF (UCD) Assignment	No Assignment (00)	00~02 (MIFM PKG Assigned Port No.
3-04	MIF (Caller ID) Assignment	No Assignment (00)	00~02 (MIFM PKG Assigned Port No.

## LK 8 Special Mode

Data No.	Memory Block Name	Default Value	Programming Values
1	ROM Version Confirmation	<i>Refer to ROM Version Confirmation on page 1-513.</i>	
2	System Speed Dial Memory Clear	<i>Refer to System Speed Dial Memory Clear on page 1-515.</i>	
3	Station Speed Dial Memory Clear	<i>Refer to Station Speed Dial Memory Clear on page 1-516.</i>	
8-800	Second Initialisation	<i>Refer to Second Initialisation on page 1-517.</i>	
—	Clock/Calendar Setting	N/A	N/A

## SECTION 4 PROGRAMMING SYSTEM DATA

This section provides detailed instructions for programming individual Memory Blocks. The Memory Blocks are listed numerically. For each Memory Block, the following information is provided.

- ④ **General Description** provides a brief explanation of the function of the Memory Block.
- ④ **Display** represents the default information displayed in the Multiline Terminal LCD during programming.
- ④ **Settings** (when applicable) provides the information that is entered using the line keys on the Multiline Terminal.
- ④ **Programming Procedures** provides detailed procedures for programming the Memory Block.
- ④ **Related Programming** (where applicable) provides a list of associated Memory Blocks that may need to be programmed.
- ④ **Notes** provides additional information related to programming the Memory Block.

THIS PAGE INTENTIONALLY LEFT BLANK

# Pause Time Selection

## General Description

A pause can be inserted between digits dialled on CO/PBX and Tie lines. Use this Memory Block to specify the length of the pause.

## Display

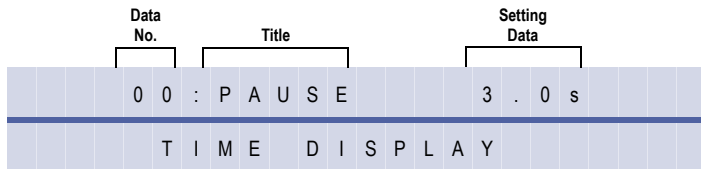

System Mode  
**1**

Submode  
**1**

Data No.  
**00**

PC Programming





 + BCM

## Settings

LK 1	LK 2	LK 3	LK 4
1 sec.	3 sec.		
LK 5	LK 6	LK 7	LK 8

The shaded area indicates the default setting.

## Programming Procedures

1	Go off-line.
2	Press LK1 + LK1 +   to access the Memory Block.
3	Press the corresponding CO/PBX line key to change the data option.
4	Press  to write the data.
5	Press  to go back on-line.

## Related Programming

M.B. Number	Memory Block Name
<b>1-1-09</b>	Manual Pause Selection
<b>1-1-24</b>	PBX/CTX Access Code Assignment I
<b>1-1-25</b>	PBX/CTX Access Code Assignment II
<b>3-91</b>	Trunk Type Selection

# N

1. A pause is automatically inserted following a behind CO/PBX Access Code (e.g., 9) by programming CO/PBX lines as PBX in Memory Block 3-91 Trunk Type Selection and 1-1-24/ 1-1-25 (PBX/CTX Access Code Assignments I/II).
2. Manual pauses can be stored for use when dialling outside lines by the Last Number Redial or Save/Store and Repeat features when Memory Block 1-1-09 Manual Pause Selection, is programmed.
3. Pauses can be stored as part of System and Station Speed Dial buffers when needed.

# DP Interdigit Time Selection

## General Description

The DP Interdigit Time is the minimum pause time interval between Dial Pulse dialling. Use this Memory Block to Select either Pattern A or Pattern B.

## Display

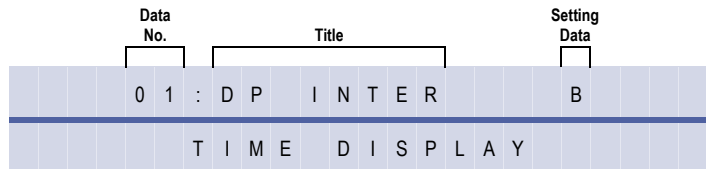

System Mode  
**1**

Submode  
**1**

Data No.  
**01**

PC Programming  
**All + BCM**

## Settings

LK 1	LK 2	LK 3	LK 4
Pattern A	Pattern B		
LK 5	LK 6	LK 7	LK 8

The shaded area indicates the default setting.

## Programming Procedures

- Go off-line.
- Press LK1 + LK1 + to access the Memory Block.
- Press the corresponding CO/PBX line key to change the data option.
 

DP Dial Data	10 pps	20 pps
Pattern A	650 ms.	500 ms.
Pattern B	800 ms.	800 ms.
- Press to write the data.
- Press to go back on-line.

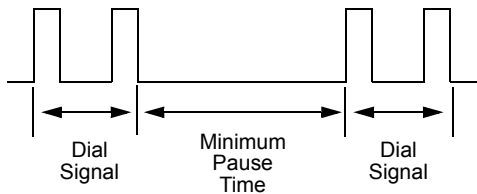

Use this Memory Block when DP Tie lines or DID are assigned in Memory Block 3-92 [Trunk (Installed, DP/DTMF Selection)] to send Dial Pulse signalling.



# Hookflash Time Selection

## General Description

Use this Memory Block to specify the loop open time for a hookflash signal sent to the CO or PBX when the Recall key on a Multiline Terminal is pressed. A Single Line Telephone (SLT) generates a hookflash to the CO or PBX line when a Single Line Telephone hookflash is assigned.

## Display

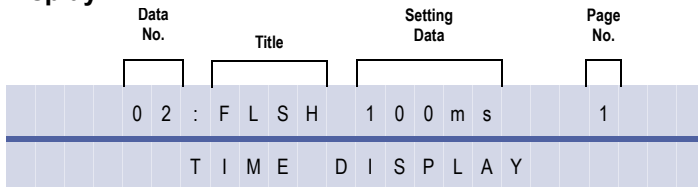

System Mode  
**1**

Submode  
**1**

Data No.  
**02**

PC Programming

+ BCM

## Settings

### (Page 1)

LK 1	LK 2	LK 3	LK 4
20 ms.	40 ms.	60 ms.	80 ms.
LK 5	LK 6	LK 7	LK 8
100 ms.	140 ms.	160 ms.	200 ms.

### (Page 2)

LK 1	LK 2	LK 3	LK 4
400 ms.	600 ms.	800 ms.	1 sec.
LK 5	LK 6	LK 7	LK 8
1.5 sec.	2 sec.	3 sec.	5 sec.

The shaded area indicates the default setting.

## Programming Procedures

<b>1</b>	Go off-line.
<b>2</b>	Press LK1 + LK1 +   to access the Memory Block.
<b>3</b>	Press the corresponding CO/PBX line key to change the data option. <b>Note:</b> Use the following to enter data: <div style="margin-left: 20px;">  to go to the next page   to go to the previous page                 </div>
<b>4</b>	Press  to write the data.
<b>5</b>	Press  to go back on-line.

## Related Programming

M.B. Number	Memory Block Name
<b>1-1-46</b>	Access Code (1-Digit) Assignment
<b>1-1-47</b>	Access Code (2-Digit) Assignment
<b>1-3-02</b>	SLT Hookflash Signal Selection
<b>4-24</b>	SLT Hookflash Assignment

# N

1. A 1- or 2-digit Access Code can be assigned in Memory Block 1-1-46 Access Code (1-Digit) Assignment and Memory Block 1-1-47 Access Code (2-Digit) Assignment, for Single Line Telephones to send a hookflash signal on a CO/PBX line (default: 6 #).
2. A hookflash from a Single Line Telephone puts an existing call on hold or sends a hookflash signal on the CO/PBX line.

# Hold Recall Timer Selection (Non Exclusive Hold)

System Mode  
**1**

Submode  
**1**

Data No.  
**03**

PC Programming  
**Alt + BM**

### General Description

Use this Memory Block to specify the time a Non-Exclusive Hold outside call is held until a recall tone is generated. If No Limit is selected, the hold recall alarm tone is not generated.

With IPK R2000 and above, this memory block allows flexible entries and has four classes.

*For R2000 only.*

### Display

Data No.	Title	Setting Data
03	H O L D R E C L	6 0 s
T I M E D I S P L A Y		

### Settings

LK 1	LK 2	LK 3	LK 4
25 sec.	45 sec.	60 sec.	90 sec.
LK 5	LK 6	LK 7	LK 8
120 sec.	180 sec.	240 sec.	No Limit

The shaded area indicates the default setting.

### Programming Procedures

1	Go off-line.
2	Press LK1 + LK1 +   to access the Memory Block.
3	Press the corresponding CO/PBX line key to change the data option.
4	Press  to write the data and display the next Memory Block.
5	Program the next Memory Block or press  to go back on-line.

*For R2000 and above.*



### Display

Data No.	Title	Class	Setting Data
03	H L D R C L	X	= 0 6 0 s
T I M E D I S P L A Y			

### Programming Procedures

1	Go off-line.	
2	Press LK1 + LK1 +   to access the Memory Block.	
3	Use the dial pad to enter the time required. <i>Note:</i> * to move cursor left. # to move cursor right. <b>Setting Data (Allow):</b> Class 1 to Class 4: 000 to 255 sec 000 = No Limit	Default values: Class 1 to Class 4 = 60 secs

**Programming Procedures** (Continued)

<b>4</b>	Press  to write the data and display the next Memory Block.
<b>5</b>	Program the next Memory Block or press  to go back on-line.

**Related Programming**

M.B. Number	Memory Block Name
<b>1-1-63</b>	Hold Recall Time Selection (Exclusive)
<b>1-2-23</b>	System Call Park Recall Time Selection
<b>4-71</b>	Time Class Assignment for Telephone Mode (R2000 and above)

**N**

1. Calls put on Exclusive Hold, recall using the data selected in Memory Block 1-1-63 Hold Recall Time Selection (Exclusive).
2. Calls placed on hold on Call Appearance keys, recall using this Memory Block.
3. Calls parked in System Call Park locations recall using Memory Block 1-2-23 System Call Park Recall Time Selection.

# Automatic Redial Time Selection

*System Mode*  
**1**

*Submode*  
**1**

*Data No.*  
**04**

*PC Programming*

 + **BM**



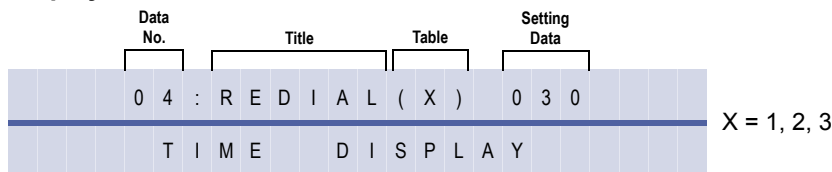

## General Description

If a called party is busy, the station user dials an Access Code and restores the handset. Use this Memory Block to define the redial timing parameters when automatic redial is set to a busy CO/PBX number. After the specified number of call attempts with no answer, the system stops dialling.

## Display



## Programming Procedures

<b>1</b>	Go off-line.													
<b>2</b>	Press LK1 + LK1 +   to access the Memory Block.													
<b>3</b>	Use the dial pad to enter the Table Number and Setting Data. <b>Note:</b> Use the following to enter data: * to move the cursor left # to move the cursor right Setting Data (Allowed): Table 1 (Calling Time):        001~050 sec. Table 2 (Call Waiting Time):   001~100 sec. Table 3 (Call Attempts):        001~009 times (3 digit input) <b>Note:</b> 000 cannot be entered.	<p><b>Default Values</b></p> <table border="1" style="width: 100%; border-collapse: collapse;"> <thead> <tr> <th>Table No.</th> <th>Description</th> <th>Value</th> </tr> </thead> <tbody> <tr> <td style="text-align: center;">1</td> <td>Calling Time</td> <td style="text-align: center;">30 sec.</td> </tr> <tr> <td style="text-align: center;">2</td> <td>Call Waiting Time</td> <td style="text-align: center;">60 sec.</td> </tr> <tr> <td style="text-align: center;">3</td> <td>Call Attempts</td> <td style="text-align: center;">2</td> </tr> </tbody> </table>	Table No.	Description	Value	1	Calling Time	30 sec.	2	Call Waiting Time	60 sec.	3	Call Attempts	2
Table No.	Description	Value												
1	Calling Time	30 sec.												
2	Call Waiting Time	60 sec.												
3	Call Attempts	2												
<b>4</b>	Press  to write the data.													
<b>5</b>	Press  to go back on-line.													

## Related Programming

No related programming is necessary for this Memory Block.

# N

1. Definitions:
  - Calling Time:*        The time that the system automatically calls the busy CO/PBX number. After the specified time limit is reached, the call is abandoned.
  - Call Waiting Time:*    The time the system waits between call attempts.
  - Call Attempts:*        The number of times the system redials the busy CO/PBX number.
2. If Call Pickup Groups are assigned using Memory Block 4-09 Telephone to Tenant Assignment, the CO lines must be assigned to the same Tenant Group in Memory Block 2-01 Trunk to Tenant Assignment for this feature to work.

# Start Timer Selection

## General Description

Use this Memory Block to specify the time needed after dialling before the system starts the Elapsed Call Timer, SMDR Start Timer, and Talk Start Timer.

With IPK R2000 and above, this memory block allows flexible entries and has four classes.

*For R2000 only.*

## Display

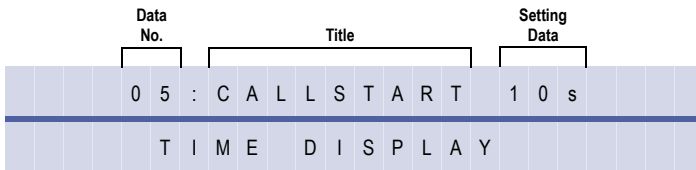

## Settings

LK 1	LK 2	LK 3	LK 4
10 sec.	20 sec.	30 sec.	40 sec.
LK 5	LK 6	LK 7	LK 8
50 sec.	60 sec.	70 sec.	2 sec.

The shaded area indicates the default setting.

## Programming Procedures

1	Go off-line.
2	Press LK1 + LK1 +   to access the Memory Block.
3	Press the corresponding CO/PBX line key to change the data option.
4	Press  to write the data.
5	Press  to go back on-line.

*For R2000 and above.*

## Display

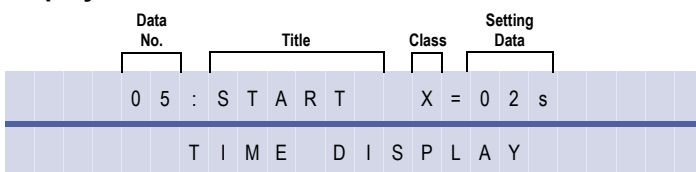



## Programming Procedures

1	Go off-line.
2	Press LK1 + LK1 +   to access the Memory Block.
3	Use the dial pad to enter the time required. Note:  to move cursor left. to move cursor right. Setting Data (Allow): Class 1 to Class 4: 00 to 99 sec 00 = No Limit
	Default values: Class 1 to Class 4 = 60 secs

System Mode  
1  
Submode  
1  
Data No.  
05  
PC Programming  
 + BM

**Programming Procedures** (Continued)

<b>4</b>	Press  to write the data and display the next Memory Block.
<b>5</b>	Program the next Memory Block or press  to go back on-line.

**Related Programming**

M.B. Number	Memory Block Name
<b>1-5-25</b>	SMDR Valid Call Timer Assignment
<b>4-71</b>	Time Class Assignment for Telephone Mode (R2000 and above)

**N**

This timer is used for three different features with functions described below:

*Elapsed Call Timer:* The time needed after dialling until the Elapsed Call Timer is started and displayed on a Multiline Terminal.

*SMDR Start Timer:* The time needed after dialling until the SMDR Valid Call Timer is started. Refer to Memory Block 1-5-25 SMDR Valid Call Timer Assignment. For outgoing calls, both timers (SMDR Start Timer and SMDR Valid Call Timer Assignment) must elapse before a call record is generated.

Lines set as "YES" in Memory Block 3-72, as having Reversal on Answer, do not follow this Memory Block.

# CO/PBX Incoming Ringing Alarm Time Selection

## General Description

Use this Memory Block to specify the time interval between the time a CO/PBX call is detected and the time the ringing tone changes to a higher pitch when the call is not answered. If No Limit is selected, the ringing tone does not change.

With IPK R2000 and above, this memory block allows flexible entries and has four classes.

*For R2000 only.*

## Display

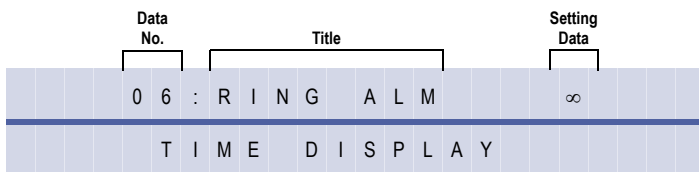

## Settings

LK 1	LK 2	LK 3	LK 4
10 sec.	20 sec.	30 sec.	∞
LK 5	LK 6	LK 7	LK 8

The shaded area indicates the default setting.

*For R2000 and above.*

## Display

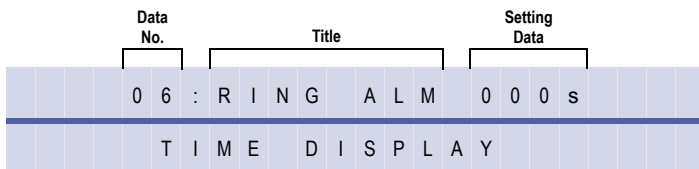

## Programming Procedures

1	Go off-line.	
2	Press LK1 + LK1 +   to access the Memory Block.	
3	Use the dial pad to enter the time required. Note:  to move cursor left. to move cursor right. Setting Data (Allow): 000 to 255 sec 000 = No Limit	Default values: Class 1 to Class 4 = 60 secs
4	Press  to write the data.	
5	Press  to go back on-line.	

System Mode  
**1**

Submode  
**1**

Data No.  
**06**

PC Programming

+ **BM**

**Related Programming**

M.B. Number	Memory Block Name
<b>1-1-07</b>	Tie Line Delay Ringing Timer Selection
<b>3-07</b>	CO/PBX Ringing Variation Selection
<b>4-01</b>	CO/PBX Ring Assignment (Day Mode)
<b>4-02</b>	CO/PBX Ring Assignment (Night Mode)
<b>4-68</b>	Telephone Ringing Variation Selection
<b>4-71</b>	Time Class Assignment for Telephone Mode (R2000 and above)

**N**

1. Memory Blocks 4-01 CO/PBX Ring Assignment (Day Mode) and 4-02 CO/PBX Ring Assignment (Night Mode) must be set to ring.
2. CO/PBX lines assigned for DIT/ANA do not activate this feature.
3. Tie/DID lines assigned for Delayed Ringing follow this assignment after the delayed ringing starts.
4. This feature uses the same ringing tone (Low, Medium, High) that can be selected in Memory Blocks 3-07 CO/PBX Ringing Variation Selection and 4-62 Telephone Ringing Variation Selection. If High is selected in those Memory Blocks, this feature does not function.
5. Select No Limit ( $\infty$ ) to disable this feature.



# Tie Line Delay Ringing Timer Selection

System Mode  
**1**

Submode  
**1**

Data No.  
**07**

PC Programming

 + **BCM**

### General Description

A Tie line call ringing at a station can begin ringing at other preassigned stations if it is not answered in a predetermined time. This Memory Block defines the time, and CO/PBX Ringing Assignment defines the preassigned station.

With IPK R2000 and above, this memory block allows flexible entries and has four classes.

### For R2000 only.

#### Display

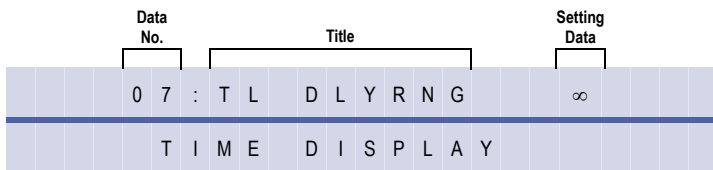

#### Settings

LK 1	LK 2	LK 3	LK 4
10 sec.	20 sec.	30 sec.	∞
LK 5	LK 6	LK 7	LK 8





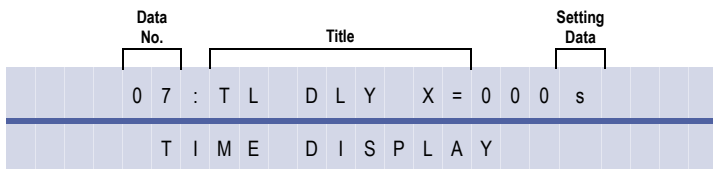

The shaded area indicates the default setting.

### For R2000 and above.

#### Display



### Programming Procedures

<b>1</b>	Go off-line.	
<b>2</b>	Press LK1 + LK1 +   to access the Memory Block.	
<b>3</b>	Use the dial pad to enter the time required. <i>Note:</i>  to move cursor left.  to move cursor right. Setting Data (Allow): Class 1 to Class 4: 000 to 255 sec 000 = No Limit	Default values: Class 1 to Class 4 = 000 secs (unlimited)
<b>4</b>	Press  to write the data.	
<b>5</b>	Press  to go back on-line.	

## Related Programming

M.B. Number	Memory Block Name
1-1-34	Tie Line First Ring Pattern Selection
4-01	CO/PBX Ring Assignment (Day Mode)
4-02	CO/PBX Ring Assignment (Night Mode)
4-12	Line Key Selection for Telephone Mode
4-71	Time Class Assignment for Telephone Mode (R2000 and above)

# N

Example:

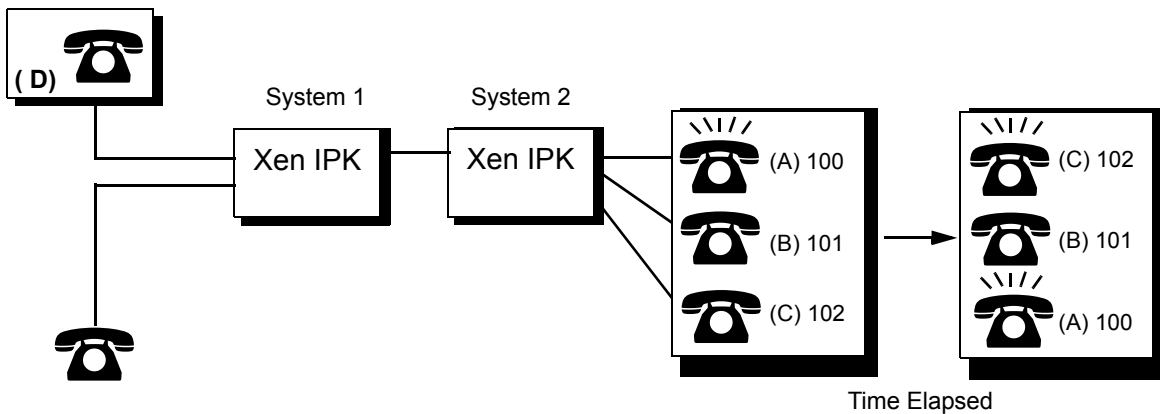

In this example, systems 1 and 2 are connected. Stations A (extension 100) and C (extension 102) are assigned to ring on the Tie line using Memory Blocks 4-01 CO/PBX Ring Assignment (Day Mode) and 4-02 CO/PBX Ring Assignment (Night Mode).

- To speak to station user A, station user D dials extension 100.
- In the example at station A:
  - ④ The ICM LED blinks and a ring tone that is different from the normal ringing tone is heard.
  - ④ The call can be answered by lifting the handset.
  - ④ Stations B and C users cannot answer the call by pressing the line key on the Multiline Terminals.
- In the example, if station user A does not answer in the specified time:
  - ④ The ringing tone changes to the normal tone and station C starts ringing.
  - ④ Any station (A, B, or C) user can answer the call by pressing the flashing line key.
- After the timeout, the system uses the Day and Night Ringing Assignment and rings the assigned station.
- Selecting No Limit ( $\infty$ ) disables this feature.

# Manual Pause Selection

## General Description

Use this Memory Block to specify either Pause Insertion or Last Number Dialed/Speed Dial to be executed using the Redial key if it is pressed after one or more digits of a dialed number are entered.

## Display

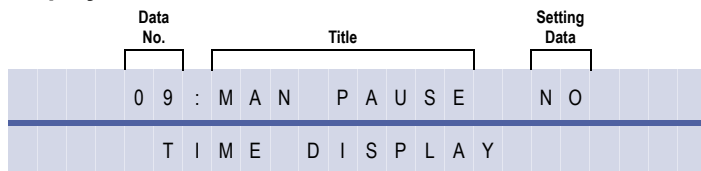

System Mode  
**1**

Submode  
**1**

Data No.  
**09**

PC Programming





 + **BTS**

## Settings

LK 1	LK 2	LK 3	LK 4
No	Yes		
LK 5	LK 6	LK 7	LK 8

The shaded area indicates the default setting.





## Programming Procedures

- 1 Go off-line.
- 2 Press LK1 + LK1 +   to access the Memory Block.
- 3 Press the corresponding CO/PBX line key to change the data option.
- 4 Press  to write the data.
- 5 Press  to go back on-line.

## Related Programming

M.B. Number	Memory Block Name
1-1-00	Hookflash Time Selection

# N

1. When a user seizes a CO/PBX line and dials the following sequence without a manual pause (this Memory Block is set to No),  
**907 4000 +  + 12345**  
 the system interprets the sequence as:  
**9074000XXX345** (XXX =  and 12 are interpreted as Speed Dial buffer 12).  
 When a user seizes a CO/PBX line and dials the following sequence with a manual pause (this Memory Block is set to Yes),  
**907 4000 +  + 12345**  
 the system interprets the sequence as:  
**9074000XXX12345** (XXX = is interpreted as a pause).
2. The pause is inserted if Last Number Redial, Save and Repeat, or Store and Repeat is used to redial the number.
3. When this feature is allowed, Multiline Terminal users cannot use consecutive Speed Dial using .

# System Transfer/Camp-On Selection

System Mode  
**1**

Submode  
**1**

Data No.  
**11**

PC Programming  
 + **BTS**

## General Description

Use this Memory Block to allow or deny (system-wide) station users the ability to perform a Ring Transfer or Station Camp-On. If allowed, Multiline Terminal users can perform a Ring Transfer by pressing the Transfer key.

With IPK R2000 and above, this memory block allows flexible entries and has four classes.

## Display





Data No.	Title	Setting Data
11	R I N G T R F	Y S
T I M E D I S P L A Y		

## Settings

LK 1	LK 2	LK 3	LK 4
No	Yes		
LK 5	LK 6	LK 7	LK 8

The shaded area indicates the default setting.

## Programming Procedures

- 1 Go off-line.
- 2 Press LK1 + LK1 +   to access the Memory Block.
- 3 Press the corresponding CO/PBX line key to change the data option.
- 4 Press  to write the data.
- 5 Press  to go back on-line.

## Related Programming

M.B. Number	Memory Block Name
1-1-12	Station Transfer/Camp-On Recall Timer Selection
4-71	Time Class Assignment for Telephone Mode (R2000 and above)



Transfers or camp-ons from Attendant Add-On Consoles are also activated using this Memory Block.

# Station Transfer/Camp-On Recall Timer Selection

## General Description

Use this Memory Block to specify the time interval before a Ring Transfer or Station Camp-On from a station (without an Attendant Add-On Console) recalls back to the originating station when the call is not answered.

*For R2000 only.*

## Display

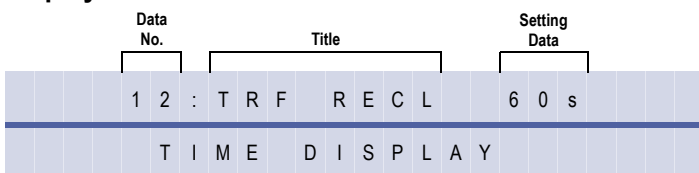

## Settings

LK 1	LK 2	LK 3	LK 4
25 sec.	45 sec.	60 sec.	90 sec.
LK 5	LK 6	LK 7	LK 8
120 sec.	180 sec.	240 sec.	No Limit

The shaded area indicates the default setting.

## Programming Procedures

- 1 Go off-line.
- 2 Press LK1 + LK1 + to access the Memory Block.
- 3 Press the corresponding CO/PBX line key to change the data option.
- 4 Press to write the data.
- 5 Press to go back on-line.

*For R2000 and above.*

## Display

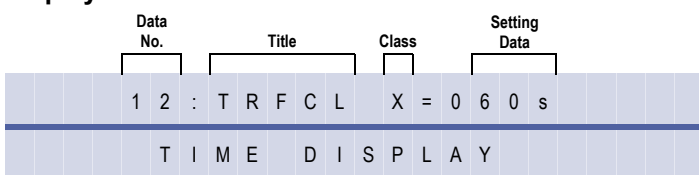



## Programming Procedures

- 1 Go off-line.
- 2 Press LK1 + LK1 + to access the Memory Block.

System Mode  
1  
Submode  
1  
Data No.  
12  
PC Programming  
 + BM

**Programming Procedures** (Continued)

<p><b>3</b> Use the dial pad to enter the time required.</p> <p><i>Note:</i> * to move cursor left. # to move cursor right.</p> <p>Setting Data (Allow): Class 1 to Class 4: 000 to 999 sec</p> <p>Limit 000 = No</p>	<p>Default values: Class 1 to Class 4 = 060 secs</p>
<p><b>4</b> Press  to write the data.</p>	
<p><b>5</b> Press  to go back on-line.</p>	

**Related Programming**

M.B. Number	Memory Block Name
1-1-11	System Transfer/Camp-On Selection
1-6-05	Attendant Add-On Console Key Selection
1-8-08	Class of Service (Station) Feature Selection 2
1-1-64	Attendant Add-On Console Transfer/Camp-On Recall Timer Selection
4-71	Time Class Assignment for Telephone Mode (R2000 and above)

**N**

When a station with an Attendant Add-On Console assigned to it transfers or camps on a call and the call goes unanswered, the call recalls using Memory Block 1-1-64 Attendant Add-On Console Transfer/Camp-On Recall Timer Selection.

# CO Transfer Ring Pattern Selection

## General Description

Use this Memory Block to select a Ring Pattern when CO transfers are made.

## Display

Data No.	Title	Setting Data	Page No.
13	COTPTN	C	1
TIME DISPLAY			

System Mode  
**1**

Submode  
**1**

Data No.  
**13**

PC Programming



+ BCS

## Settings

(Page 1)

LK 1	LK 2	LK 3	LK 4
Tone Off	Tone On	Pattern A	Pattern B
LK 5	LK 6	LK 7	LK 8
Pattern C	Pattern D	Pattern E	Pattern F

(Page 2)

LK 1	LK 2	LK 3	LK 4
Pattern G	Pattern H		
LK 5	LK 6	LK 7	LK 8

The shaded area indicates the default setting

## Programming Procedures

1	Go off-line.
2	Press LK1 + LK1 +   to access the Memory Block.
3	Press the corresponding CO/PBX line key to change the data option. <b>Note:</b> Use the following to enter data: to access the next page to access the previous page.
4	Press  to write the data.
5	Press  to go back on-line.

## Related Programming

M.B. Number	Memory Block Name
1-1-11	System Transfer/Camp-On Selection
1-1-14	CO Transfer Ring Tone Selection

The Ring Patterns are shown in the table below:

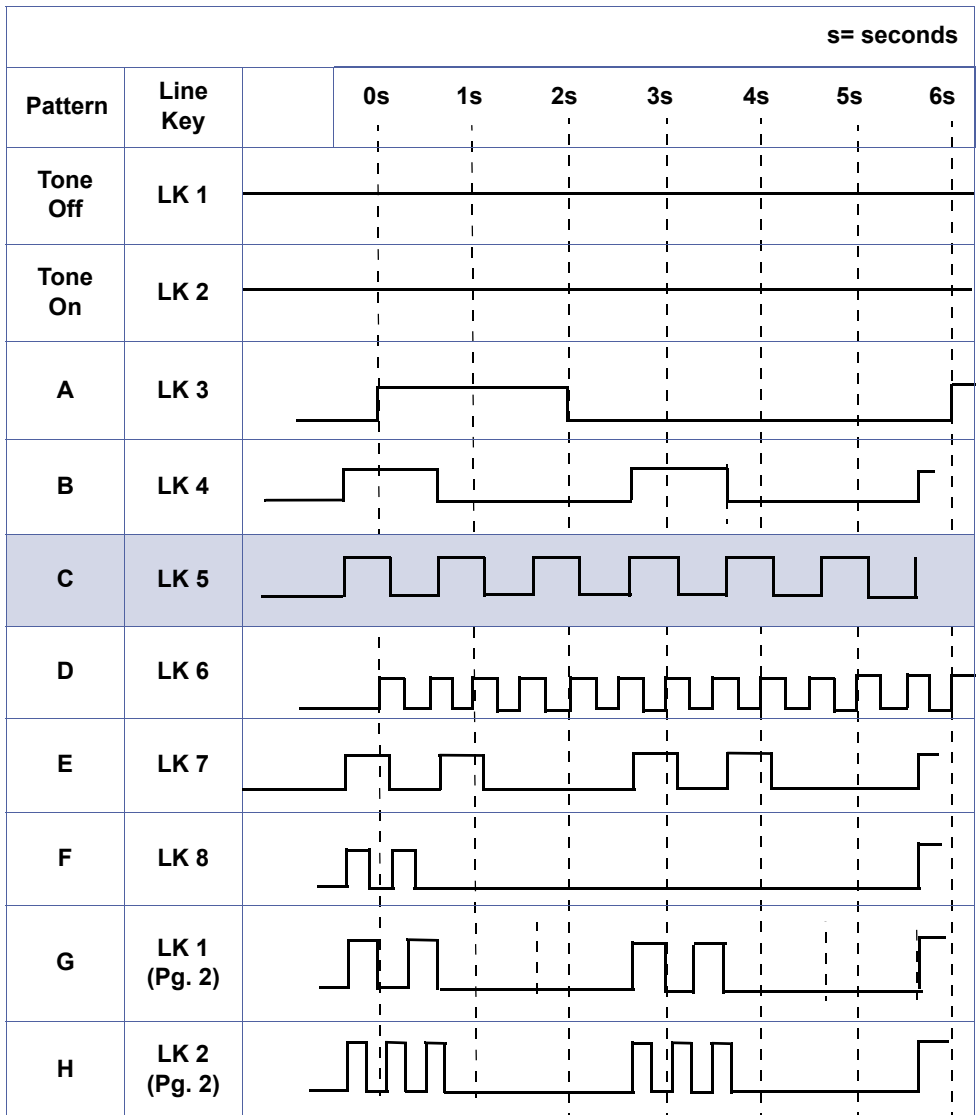



# CO Transfer Ring Tone Selection

## General Description

Use this Memory Block to select a ring tone for CO transfers.

## Display

Data No.	Title	Setting Data
14	C O T R F T O N E	A
T I M E D I S P L A Y		

## Settings

LK 1	LK 2	LK 3	LK 4
Tone A	Tone B	Tone C	Tone D
LK 5	LK 6	LK 7	LK 8
Tone E	Tone F	Tone G	Tone H

The shaded area indicates the default setting.

## Programming Procedures

1	Go off-line.																		
2	Press LK1 + LK1 +   to access the Memory Block.																		
3	Press the corresponding CO/PBX line key to change the data option. The available tones are:																		
	<table border="1"> <thead> <tr> <th>Tone</th> <th>Frequency</th> </tr> </thead> <tbody> <tr> <td>Tone A</td> <td>480/600 (Modulation - 16 Hz)</td> </tr> <tr> <td>Tone B</td> <td>480/606 (Modulation - 8 Hz)</td> </tr> <tr> <td>Tone C</td> <td>1024/1285</td> </tr> <tr> <td>Tone D</td> <td>1024</td> </tr> <tr> <td>Tone E</td> <td>500</td> </tr> <tr> <td>Tone F</td> <td>1024/1285 (Modulation - 16 Hz)</td> </tr> <tr> <td>Tone G</td> <td>600/700 (Modulation - 16 Hz)</td> </tr> <tr> <td>Tone H</td> <td>1024 (Envelope - 2 sec.)</td> </tr> </tbody> </table>	Tone	Frequency	Tone A	480/600 (Modulation - 16 Hz)	Tone B	480/606 (Modulation - 8 Hz)	Tone C	1024/1285	Tone D	1024	Tone E	500	Tone F	1024/1285 (Modulation - 16 Hz)	Tone G	600/700 (Modulation - 16 Hz)	Tone H	1024 (Envelope - 2 sec.)
Tone	Frequency																		
Tone A	480/600 (Modulation - 16 Hz)																		
Tone B	480/606 (Modulation - 8 Hz)																		
Tone C	1024/1285																		
Tone D	1024																		
Tone E	500																		
Tone F	1024/1285 (Modulation - 16 Hz)																		
Tone G	600/700 (Modulation - 16 Hz)																		
Tone H	1024 (Envelope - 2 sec.)																		
4	Press  to write the data.																		
5	Press  to go back on-line.																		

System Mode  
**1**

Submode  
**1**

Data No.  
**14**

PC Programming



# System Speed Dial Restriction by Tenant

## General Description

Use this Memory Block to specify whether or not System Speed Dial is restricted for each tenant.

## Display

Data No.	Title	Speed Dial Buffer No.	Starting Tenant No. Groups of 8
18	SPEED (0X)		00
T I M E D I S P L A Y			

*System Mode*  
**1**  
*Submode*  
**1**  
*Data No.*  
**18**  
*PC Programming*  
 + AC

## Settings

### (Page 1) Tenants 00~07

LK 1	LK 2	LK 3	LK 4
00	01	02	03
LK 5	LK 6	LK 7	LK 8
04	05	06	07

### (Page 2) Tenants 08~15

LK 1	LK 2	LK 3	LK 4
08	09	10	11
LK 5	LK 6	LK 7	LK 8
12	13	14	15

### (Page 3) Tenants 16~23

LK 1	LK 2	LK 3	LK 4
16	17	18	19
LK 5	LK 6	LK 7	LK 8
20	21	22	23

### (Page 4) Tenants 24~31

LK 1	LK 2	LK 3	LK 4
24	25	26	27
LK 5	LK 6	LK 7	LK 8
28	29	30	31

### (Page 5) Tenants 32~39











LK 1	LK 2	LK 3	LK 4
32	33	34	35
LK 5	LK 6	LK 7	LK 8
36	37	38	39

### (Page 6) Tenants 40~47

LK 1	LK 2	LK 3	LK 4
40	41	42	43
LK 5	LK 6	LK 7	LK 8
44	45	46	47

Six pages are available to access the Tenant Numbers. Tenant Numbers 00~47 correspond to the line keys listed in the table to the left.

**Programming Procedures**

<b>1</b>	Go off-line.																														
<b>2</b>	Press LK1 + LK1 +   to access the Memory Block.																														
<b>3</b>	<p>Press the corresponding CO/PBX line key to change the tenant number. Speed Dial buffers have nine groups. These groups are listed in the table</p> <table border="1" style="margin-left: 20px;"> <thead> <tr> <th rowspan="2">Speed Dial Buffer No.</th> <th colspan="2">Speed Dial Number</th> </tr> <tr> <th>80 Codes</th> <th>1000 Codes</th> </tr> </thead> <tbody> <tr> <td>0X</td> <td>00~09</td> <td>000~099</td> </tr> <tr> <td>1X</td> <td>10~19</td> <td>100~199</td> </tr> <tr> <td>2</td> <td>2</td> <td>2</td> </tr> <tr> <td>6X</td> <td>60~69</td> <td>600~699</td> </tr> <tr> <td>7X</td> <td>70~79</td> <td>700~799</td> </tr> <tr> <td>8X</td> <td>N/A</td> <td>800~899</td> </tr> </tbody> </table> <p style="margin-left: 40px;">X = Any digit 0~9</p> <p><b>Note:</b> Use the following to enter data:</p> <ul style="list-style-type: none"> <li> to move the cursor left</li> <li> to move the cursor right</li> <li> ~  to enter numeric data</li> <li> to move to the next page</li> <li> to move to the previous page</li> </ul> <p>Each time a CO/PBX line key is pressed, the LED toggles between On and Off.</p> <table border="1" style="margin-left: 20px; margin-top: 10px;"> <thead> <tr> <th>CO/PBX Line LED</th> <th>Off</th> <th>On</th> </tr> </thead> <tbody> <tr> <td>Data</td> <td>Restricted</td> <td>Not restricted</td> </tr> </tbody> </table>	Speed Dial Buffer No.	Speed Dial Number		80 Codes	1000 Codes	0X	00~09	000~099	1X	10~19	100~199	2	2	2	6X	60~69	600~699	7X	70~79	700~799	8X	N/A	800~899	CO/PBX Line LED	Off	On	Data	Restricted	Not restricted	<p><b>Default Values</b> All System Speed Dial buffers can be dialled from any tenant.</p>
Speed Dial Buffer No.	Speed Dial Number																														
	80 Codes	1000 Codes																													
0X	00~09	000~099																													
1X	10~19	100~199																													
2	2	2																													
6X	60~69	600~699																													
7X	70~79	700~799																													
8X	N/A	800~899																													
CO/PBX Line LED	Off	On																													
Data	Restricted	Not restricted																													
<b>4</b>	After entering all pages for the selected Speed Dial Buffer No., press  to write the data. The next Speed Dial Buffer No. is displayed.																														
<b>5</b>	After entering data for all of the Speed Dial Buffer Nos., press  to write the data for the last Speed Dial Buffer No. The next Memory Block is displayed.																														
<b>6</b>	Press  to go back on-line.																														

**Related Programming**

M.B. Number	Memory Block Name
<b>1-1-33</b>	Speed Dial Number/Name Display Selection
<b>1-1-35</b>	Speed Dial Buffer Allocation
<b>2-01</b>	Trunk to Tenant Assignment
<b>4-09</b>	Telephone to Tenant Assignment

**N**

1. One or more tenants can be enabled to use each group.
2. Use this Memory Block to assign which tenants use each group.
3. When speed dial is set to 1000, 900~999 cannot be restricted.
4. The X in each Speed Dial Buffer No. is displayed even if it is not entered.
5. In Memory Block *1-1-18 System Speed Dial Restriction by Tenant*, tenant numbers 00~07 are assigned to Flexible Line keys on the first page. Tenant numbers 08~15 are assigned to the Flexible Line keys on the second page. The tenant number corresponding to Flexible Line key 1 of the current page is displayed on the right side of the display. In all cases, each page is represented by eight line keys.

# Line Selection for Automatic Outgoing Calls

## General Description

Use this Memory Block to specify which trunks will be used when a call is made using the Code Restriction Password Override Feature.

## Display

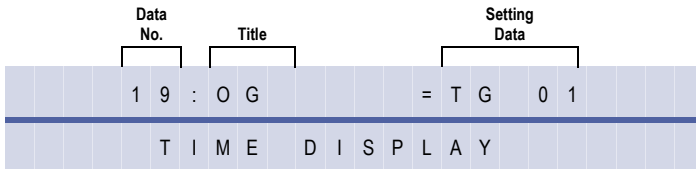

System Mode  
**1**

Submode  
**1**

Data No.  
**19**





PC Programming  
 + **BO**

## Settings

LK 1	LK 2	LK 3	LK 4
NON	CO	PBX	TIE
LK 5	LK 6	LK 7	LK 8
TG 01	RAB 01		

The shaded area indicates the default setting.

## Programming Procedures

1	Go off-line.	
2	Press LK1 + LK1 +   to access the Memory Block.	
3	Press the corresponding CO/PBX line key to change the data option.	TG Setting = Trunk group (01~32) RAB Setting = Route Advance Block (01~32)
4	Press  to write the data.	
5	Press  to go back on-line.	

## Related Programming

No related programming is necessary for this Memory Block.

# DID Digit Length Selection

## General Description

This Memory Block defines the Direct Inward Dialling (DID) digit length in Memory Block 1-1-22.

## Display

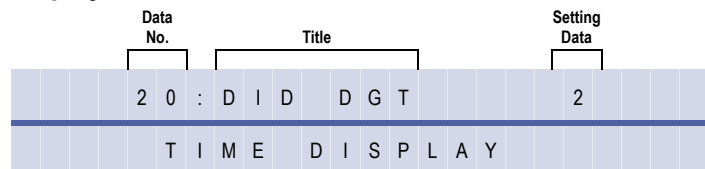

System Mode  
**1**

Submode  
**1**

Data No.  
**20**

PC Programming  
 + ALN

## Programming Procedures

1	Go off-line.	
2	Press LK1 + LK1 +   to access the Memory Block.	
3	Enter the data using the dial pad. <b>Note:</b> Use the following to enter data:	<b>Default Values</b> 2
	<ul style="list-style-type: none"> <li> to move the cursor left</li> <li> to move the cursor right</li> <li> ~  to enter numeric data 2, 3, or 4</li> <li> to insert a pause</li> <li> to clear all data</li> </ul>	
4	Press  to write the data.	
5	Press  to go back on-line.	

## Related Programming

M.B. Number	Memory Block Name
1-1-21	DID Digit Conversion Assignment
1-1-22	DID Digit Conversion Table & DNIS Assignment
1-1-23	DID Forward Station Number for Busy Station or Undefined Digit
5-00	Digit Add/Del for Tie Line Networking

# DID Digit Conversion Assignment

## General Description

Use this Memory Block to enable the DID Digit Conversion Table & DNIS Assignment, Memory Block 1-1-22, for each number. If No is assigned here, only Memory Block 5-00 has an impact on incoming DID numbers. If Yes is assigned here, incoming DID numbers can be modified completely for each number.

## Display

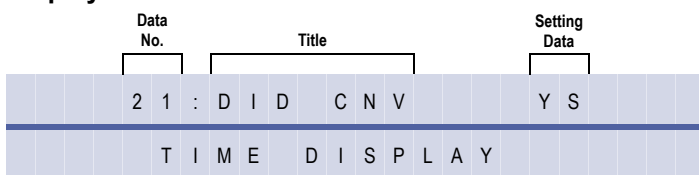

## Settings

LK 1	LK 2	LK 3	LK 4
No	Yes		
LK 5	LK 6	LK 7	LK 8

The shaded area indicates the default setting.

## Programming Procedures

1	Go off-line.	
2	Press LK1 + LK1 +   to access the Memory Block.	
3	Enter the data using the Line key.	<b>Default Values</b> NO
4	Press  to write the data.	
5	Press  to go back on-line.	

## Related Programming

M.B. Number	Memory Block Name
1-1-20	DID Digit Length Selection
1-1-22	DID Digit Conversion Table & DNIS Assignment
1-1-23	DID Forward Station Number for Busy Station or Undefined Digit

System Mode  
1  
Submode  
1  
Data No.  
21  
PC Programming  
 + ALN

# DID Digit Conversion Table & DNIS Assignment

System Mode  
**1**

Submode  
**1**

Data No.  
**22**

PC Programming  
 + ALN

## General Description

Up to 200 incoming DID numbers can be assigned individually to ring at preassigned extension numbers on a day mode and night mode basis. This Memory Block applies to the DID number after it is modified by Memory Block 5-00.

## Display

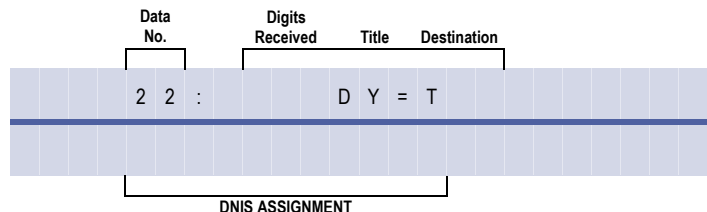













## Settings

LK 1	LK 2	LK 3	LK 4
TEL=T	TENANT=TN		
LK 5	LK 6	LK 7	LK 8

The shaded area indicates the default setting.

## Programming Procedures

1	Go off-line.	
2	Press LK1 + LK1 +   to access the Memory Block.	
3	Enter the data using the dial pad. <b>Note:</b> Use the following to enter data:  to move the cursor left  to move the cursor right  ~  to enter numeric data  to change DNIS, then use  ~  to enter an alphanumeric name for each initial number (name applies to both day and night mode). Refer to <i>Table 1, "System Data Input,"</i> on page 541 for details on character entry.  to change between Day and Night table  to clear all data	<b>Default Values</b> Not Assigned. <b>Setting Data</b> TEL = LK1 = Extension No. 00~99 000~999 0000~9999 TENANT = LK2 = 00~47
4	Press  to write the data.	
5	Press  to go back on-line.	

## Related Programming

M.B. Number	Memory Block Name
1-1-20	DID Digit Length Selection
1-1-21	DID Digit Conversion Assignment
1-1-23	DID Forward Station Number for Busy Station or Undefined Digit
4-01	CO/PBX Ring Assignment (Day Mode)



**Related Programming**

M.B. Number	Memory Block Name
4-02	CO/PBX Ring Assignment (Night Mode)
4-09	Telephone to Tenant Assignment
5-00	Digit Add/Del for Tie Line Networking

**N**

1. LK1 - Call come in as direct indial.
2. LK2 - Calls will ring as a normal CO Ring and following Ring Assignment Day/Night.

# DID Forward Station Number for Busy Station or Undefined Digit

System Mode  
**1**

Submode  
**1**

Data No.  
**23**

PC Programming  
 + ALN

### General Description

This Memory Block is used when Memory Block 1-1-21 DID Digit Conversion Assignment is enabled. Undefined Digits are classified as in-dial numbers not listed in Memory Block 1-1-22 DID Digit Conversion Table & DNIS Assignment.

### Display











Data No.	Title	Setting Data
23	TRFEXT	NON
TIME DISPLAY		

### Settings

LK 1	LK 2	LK 3	LK 4
NON	TEL	TENANT	
LK 5	LK 6	LK 7	LK 8

The shaded area indicates the default setting.

### Programming Procedures

1	Go off-line.	
2	Press LK1 + LK1 +   to access the Memory Block.	
3	Enter the data using the dial pad. <b>Note:</b> Use the following to enter data:  to move the cursor left  to move the cursor right  ~  to enter numeric data  to insert a pause  to clear all data	<b>Default Values</b> NON <b>Setting Data</b> Tel = Extension No. 00~99 000~999 0000~9999 TN = Tenant No. 00~47
4	Press  to write the data.	
5	Press  to go back on-line.	

### Related Programming

M.B. Number	Memory Block Name
1-1-22	DID Digit Conversion Table & DNIS Assignment

**N**

1. MB 1-1-23 DID Forward Station Number for Busy Station or Undefined Digit is only used when MB 1-1-21 DID Digit Conversion Assignment is enabled (e.g. set to 'Y').
2. Call Forward Busy, Station Hunting or Call Alert Notification should be used to accommodate direct indial calls to busy stations.
3. When this Memory Block is set to a Tenant, the following must be assigned to ring the desired station:  
Memory Block 4-01 [CO/PBX Ring Assignment (Day Mode)]  
Memory Block 4-02 [CO/PBX Ring Assignment (Night Mode)]  
Memory Block 4-09 (Telephone to Tenant Assignment).

# PBX/CTX Access Code Assignment I

*System Mode*  
**1**

*Submode*  
**1**

*Data No.*  
**24**

*PC Programming*  
 + BA







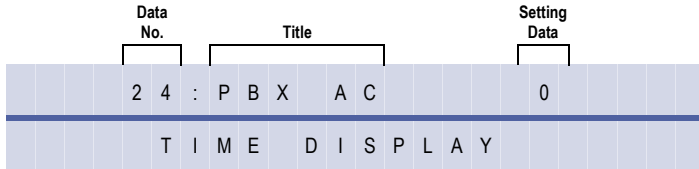

## General Description

Use this Memory Block to specify a PBX line PBX/CTX Access Code together with pauses for outgoing calls.

## Display

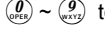

## Programming Procedures

<b>1</b>	Go off-line.	
<b>2</b>	Press LK1 + LK1 +   to access the Memory Block.	
<b>3</b>	Enter the data using the dial pad. <b>Note:</b> Use the following to enter data:	<b>Default Values</b> 0-
	<ul style="list-style-type: none"> <li> to move the cursor left</li> <li> to move the cursor right</li> <li> to enter numeric data</li> <li> to insert a pause</li> <li> to clear all data</li> </ul>	
<b>4</b>	Press  to write the data.	
<b>5</b>	Press  to go back on-line.	

## Related Programming

M.B. Number	Memory Block Name
<b>3-92</b>	Trunk Type Selection



Example:

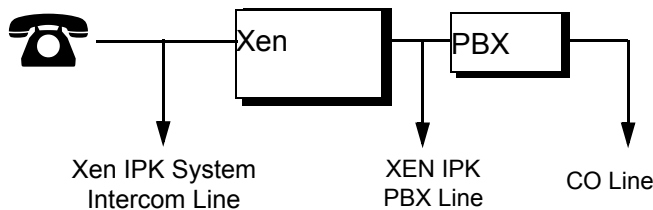

1. Features such as Code Restriction do not operate properly unless a PBX/CTX Access Code is specified. This limitation applies to PBX lines assigned in Memory Block 3-92 Trunk Type Selection.
2. A pause is not inserted in the number of an outgoing call on a CO line.
3. Up to three numeric characters and three pauses can be specified.
4. A pause cannot be inserted as the first digit or as consecutive digits.
5. A -(dash) is the entry for pause.

# PBX/CTX Access Code Assignment II

System Mode  
1

Submode  
1

Data No.  
25

PC Programming



## General Description

Use this Memory Block to specify a second PBX line PBX/CTX Access Code together with pauses for outgoing calls.

## Display

Data No.	Title	Setting Data
25	PBXAC	8-
T I M E D I S P L A Y		

## Programming Procedures

1	Go off-line.	
2	Press LK1 + LK1 +   to access the Memory Block.	
3	Enter the option using the dial pad. <b>Note:</b> Use the following to enter data: to move the cursor left to move the cursor right to enter numeric data to insert a pause (cannot be first digit) to clear all data	<b>Default Values</b> 8-
4	Press  to write the data.	
5	Press  to go back on-line.	

## Related Programming

M.B. Number	Memory Block Name
3-92	Trunk Type Selection

N

Example:

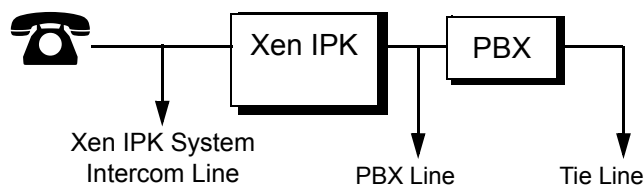

1. Features such as Code Restriction do not operate properly unless a PBX/CTX Access Code is specified. This limitation only applies to PBX lines assigned in Memory Block 3-92 Trunk Type Selection.
2. A pause is not inserted in the number of an outgoing call on a CO line.
3. Up to three numeric characters and three pauses can be specified.
4. A pause cannot be inserted as the first or as consecutive digits.

# Automatic Day/Night Mode Switching Time Assignment

System Mode  
**1**

Submode  
**1**

Data No.  
**27**

PC Programming  
 + BM







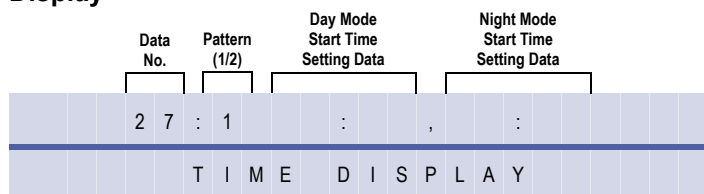



## General Description

Use this Memory Block to assign Pattern 1 and Pattern 2 start times for automatically switching between Day Mode and Night Mode.

## Display



## Programming Procedures

1	Go off-line.	
2	Press LK1 + LK1 +   to access the Memory Block.	
3	Enter the data using the dial pad. <b>Note:</b> Use the following to enter data:  to move the cursor left  to move the cursor right  ~  to enter numeric data  to clear all data when the cursor is in the Data No. position	<b>Default Values</b> Not Specified
4	Press  to write the data. The switching time for pattern 2 is displayed.	
5	Use the dial pad to change the time.	
6	Press  to write the data.	
7	Press  to go back on-line.	

## Related Programming

M.B. Number	Memory Block Name
1-1-32	Automatic Day/Night Mode by Day of Week Selection
1-4-05	Automatic Tandem Trunk by Night Mode Selection
1-8-07	Class of Service (Attendant) Feature Selection 1
4-07	Code Restriction Class Assignment (Day Mode)
4-08	Code Restriction Class Assignment (Night Mode)
4-09	Telephone to Tenant Assignment
4-17	Station to Class of Service Feature Assignment
4-37	Extension Line Key Ring Assignment (Day Mode)
4-38	Extension Line Key Ring Assignment (Night Mode)

---

# N

1. The start times for Day Mode or Night Mode can be specified in System Programming to automatically switch modes at the specified times.
2. A start time for Day Mode only or Night Mode only cannot be programmed.
3. Day Mode and Night Mode cannot be programmed to have the same start time.
4. The time is entered in 24-hour time only.
5. The first time input indicates when Day Mode starts. The second time input indicates when Night Mode starts.
6. Refer to Memory Block 1-1-32 Automatic Day/Night Mode by Day of Week Selection for selecting either Pattern 1 or Pattern 2 Day/Night Mode start times for each day of the week. Assigning each day of the week to either Pattern 1 or Pattern 2 allows Day/Night Mode start times for Monday through Friday to differ from Day/Night Mode start times for Saturday and Sunday.

# Distinctive Ringing by Telephone or CO Selection

## General Description

Use this Memory Block to assign distinctive ringing tone for each telephone or each CO/PBX line.

## Display

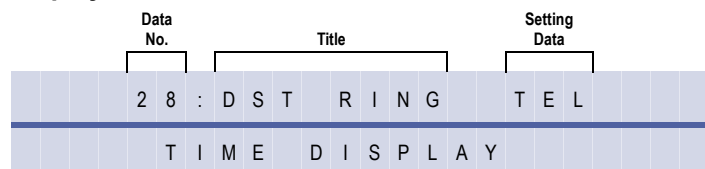

System Mode  
**1**

Submode  
**1**

Data No.  
**28**

PC Programming  
 + **BTS**

## Settings

LK 1	LK 2	LK 3	LK 4
TEL	CO		
LK 5	LK 6	LK 7	LK 8

The shaded area indicates the default setting.

## Programming Procedures

1	Go off-line.
2	Press LK1 + LK1 +   to access the Memory Block.
3	Press the corresponding CO/PBX line key to change the data option.
4	Press  to write the data.
5	Press  to go back on-line.

## Related Programming

M.B. Number	Memory Block Name
3-07	CO/PBX Ringing Variation Selection
4-01	CO/PBX Ring Assignment (Day Mode)
4-02	CO/PBX Ring Assignment (Night Mode)
4-62	Telephone Ringing Variation Selection



1. TEL = Telephone Mode  
Ringing tone is specified in Memory Block 4-62 Telephone Ringing Variation Selection.
2. CO = CO/PBX Line Mode  
Ringing tone is specified for each CO/PBX line in Memory Block 3-07 CO/PBX Ringing Variation Selection.



# Private Line Assignment

## General Description

Use this Memory Block to assign an outside line for use as a private line. The private line cannot be seized by any other telephone, and no LED indication is provided to other terminals.

## Display

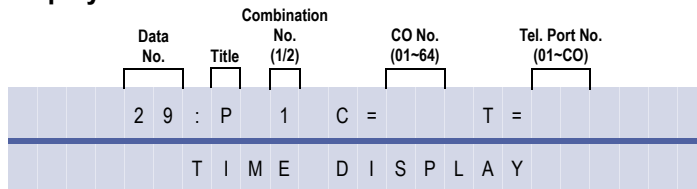

System Mode  
**1**

Submode  
**1**

Data No.  
**29**

PC Programming

+ BCS

## Programming Procedures

<b>1</b>	Go off-line.	
<b>2</b>	Press LK1 + LK1 +   to access the Memory Block.	
<b>3</b>	Enter the data using the dial pad. <b>Note:</b> Use the following to enter data: to move the cursor left to move the cursor right to enter numeric data to clear all data when cursor is at CO No. or Tel. Port No.	<b>Default Values</b> Not Specified
<b>4</b>	Press  to write the data. Data for the second line is displayed. Move the cursor to change the data.	
<b>5</b>	Press  to write the data.	
<b>6</b>	Press  to go back on-line.	

## Related Programming

M.B. Number	Memory Block Name
<b>2-06</b>	Line Key Selection for Tenant Mode
<b>4-12</b>	Line Key Selection for Telephone Mode

# N

- Two private lines can be assigned to one station or one private line can be assigned to two stations.
- A Single Line Telephone (SLT) user cannot dial the Trunk Group Access Code to access a private line. The Single Line Telephone user can access the line by dialling the specified Line Seizure Access Code assigned in Memory Blocks 1-1-46/ 1-1-47 Access Code (1-digit/2 -digit) Assignment (Function 063 or 064).
- If a station is allowed Barge-In originate, and a second station is allowed Barge-In receive, Barge-In is not allowed on a private line unless both stations share the private line.

# Route Advance Block Assignment

*System Mode*  
**1**  
*Submode*  
**1**  
*Data No.*  
**30**  
*PC Programming*  



## General Description

Use this Memory Block to assign priority levels (1~4) to each Trunk Group assigned in a Route Advance Block. The system has 32 blocks that can be specified.





## Display

Data No.	Title	Block No. (1~16)	Priority No. (1~4)	Setting Data
30	RTADV01	-	1	=00
T I M E D I S P L A Y				





## Programming Procedures

- Go off-line.
- Press LK1 + LK1 +   to access the Memory Block.
- Enter the data using the dial pad.
 

**Note:** Use the following to enter data:

  -  to move the cursor left
  -  to move the cursor right
  -  ~  to enter numeric data

Block No.	Priority No.	Setting Data
1	1	Trunk Groups 01~32
	2	Trunk Groups 01~32
	3	Trunk Groups 01~32
	4	Trunk Groups 01~32
}	}	}
32	1	Trunk Groups 01~32
	2	Trunk Groups 01~32
	3	Trunk Groups 01~32
	4	Trunk Groups 01~32

**Default Values**  
All Blocks (00)
- Press  to write the data. Data for the Priority Nos. 2~4 are displayed in succession.
- After entering the data for Priority No. 4, press  to write the data. Data for Priority 1 for the next Block No. is displayed.
- After entering data for Block No. 32, press  to write the data. The next Memory Block is displayed.
- Press  to go back on-line.

## Related Programming

M.B. Number	Memory Block Name
<b>3-03</b>	Trunk-to-Trunk Group Assignment

**N**

1. If 00 (Not Set) is programmed, no trunks are accessed for this priority setting.
2. If Route Advance Block Numbers are assigned and a line key is pressed or an Access Code is dialed, the system starts searching for an idle line in a specified group (beginning with the Trunk Group assigned priority 1).
3. If all CO/PBX lines are in use, the line with the next highest priority is seized.
4. Route Advance Block Number Access Codes are defined in Memory Block 1-1-46 Access Code (1-Digit) Assignment or Memory Block 1-1-47 Access Code (2-Digit) Assignment.



# N

By designating two time settings in Memory Block 1-1-27 Automatic Day/Night Mode Switching Time Assignment, one of the two settings can be assigned to each day of the week.

For Example:

To specify Day/Night Mode automatic switching time for Monday ~ Friday, and Day/Night Mode automatic switching time for Saturday and Sunday, press CO/PBX line keys 1 and 7.

### Related Programming

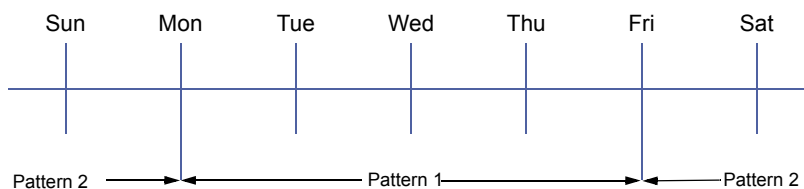

# Speed Dial Number/Name Display Selection

## General Description

Use this Memory Block to specify whether the dialled number or name is displayed first on the LCD of the originating station when an outgoing call is made using Speed Dial.

## Display

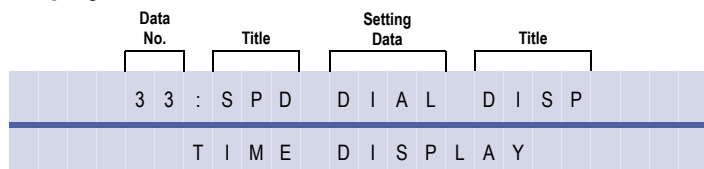

System Mode  
**1**

Submode  
**1**

Data No.  
**33**





PC Programming  
 + BE

## Settings

LK 1	LK 2	LK 3	LK 4
Dialled Number	Name		
LK 5	LK 6	LK 7	LK 8

The shaded area indicates the default setting.

## Programming Procedures

- 1 Go off-line.
- 2 Press LK1 + LK1 +   to access the Memory Block.
- 3 Press the corresponding CO/PBX line key to change the data option.
- 4 Press  to write the data.
- 5 Press  to go back on-line.

## Related Programming

M.B. Number	Memory Block Name
1-1-18	System Speed Dial Restriction by Tenant
1-1-35	Speed Dial Buffer Allocation



If a message (the name of the dialled party) is not entered, only the dialled number is displayed regardless of programming in the Memory Block.

# Tie Line First Ring Pattern Selection

## General Description

Use this Memory Block to set specific ringing tones for incoming calls on Tie lines. After a delay interval specified in Memory Block 1-1-07 Tie Line Delay Ringing Timer Selection, a Tie call can ring at all Day/Night ring-assigned telephones using a different cadence.

## Display

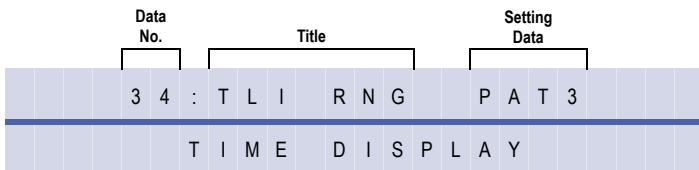

## Settings

LK 1	LK 2	LK 3	LK 4
Pattern 1	Pattern 2	Pattern 3	Pattern 4
LK 5	LK 6	LK 7	LK 8
ICM	Voice		

The shaded area indicates the default setting.

## Programming Procedures

1	Go off-line.
2	Press LK1 + LK1 +   to access the Memory Block.
3	Press the corresponding CO/PBX line key to change the data option.
4	Press  to write the data.
5	Press  to go back on-line.

## Related Programming

M.B. Number	Memory Block Name
1-1-07	Tie Line Delay Ringing Timer Selection
1-1-53	Tie Line Delay Ring Pattern Selection
4-01	CO/PBX Ring Assignment (Day Mode)
4-02	CO/PBX Ring Assignment (Night Mode)

# N

1. Specify one pattern in the Ringing Pattern Selection Table.
2. If Voice is selected, switching from voice to tone is not allowed, Memory Block 1-1-07 is not used, and Handsfree Answerback is not allowed at the receiving station.

System Mode  
1

Submode  
1

Data No.  
34

PC Programming  
 + ALN

Ringing Pattern Selection

s= seconds

Pattern		0s	1s	2s	3s	4s	5s	6s
1								
2								
3								
4								
5		Same as Internal Ring						
6		Voice Announce						



# Speed Dial Buffer Allocation

## General Description

Use this Memory Block to specify either 100-memory or 1000-memory allocation.

## Display

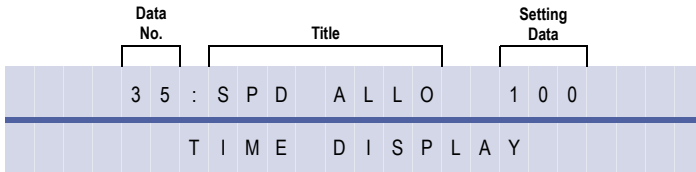

System Mode  
**1**

Submode  
**1**

Data No.  
**35**

PC Programming





 + BE

## Settings

LK 1	LK 2	LK 3	LK 4
100 Memories	1000 Memories		
LK 5	LK 6	LK 7	LK 8

The shaded area indicates the default setting.

## Programming Procedures

<b>1</b>	Go off-line.
<b>2</b>	Press LK1 + LK1 +   to access the Memory Block.
<b>3</b>	Press the corresponding CO/PBX line key to change the data option.
<b>4</b>	Press  to write the data.
<b>5</b>	Press  to go back on-line.

## Related Programming

M.B. Number	Memory Block Name
<b>1-1-18</b>	System Speed Dial Restriction by Tenant
<b>1-1-33</b>	Speed Dial Number/Name Display Selection

# N

1. The 100-memory option allows 80 System Speed Dial memories and 20 Station Speed Dial memories.
2. The 1000-memory option does not allow Station Speed Dial memories.

# Trunk Queuing Timeout Selection

## General Description

Use this Memory Block to specify the time that a station with Trunk Queue set rings, before the queue is automatically cancelled.

With IPK R2000 and above, this memory block allows flexible entries and has four classes.

*For R2000 only.*

## Display

Data No.	Title	Setting Data
3 7	TRUNK QUEUE	1 0 s
TIME DISPLAY		

## Settings

LK 1	LK 2	LK 3	LK 4
10 sec.	20 sec.	30 sec.	60 sec.
LK 5	LK 6	LK 7	LK 8

The shaded area indicates the default setting.

## Programming Procedures

- 1 Go off-line.
- 2 Press LK1 + LK1 + to access the Memory Block.
- 3 Press the corresponding CO/PBX line key to change the data option.
- 4 Press to write the data.
- 5 Press to go back on-line.

*For R2000 and above.*

## Display

Data No.	Title	Class	Setting Data
3 7	TRK QUEUE	X =	1 0 s
TIME DISPLAY			

## Programming Procedures

- 1 Go off-line.
- 2 Press LK1 + LK1 + to access the Memory Block.



System Mode  
**1**

Submode  
**1**

Data No.  
**37**

PC Programming  
 + BM

**Programming Procedures** (Continued)

<b>3</b>	Use the dial pad to enter the time required. <i>Note:</i> * to move cursor left. # to move cursor right.  Setting Data (Allow): Class 1 to Class 4: 000 to 999 sec  Limit <span style="float: right;">000 = No</span>	Default values:  Class 1 to Class 4 = 10 secs
<b>4</b>	Press  to write the data.	
<b>5</b>	Press  to go back on-line.	

**Related Programming**

<b>4-71</b>	Time Class Assignment for Telephone Mode (R2000 and above)
-------------	--

**N**

When all trunks in a particular Trunk Group are busy, the station user can dial an Access Code to queue on the busy Trunk Group. When a Trunk (in that group) becomes idle, the queued station is signalled.

# Access Code (1-Digit) Assignment

System Mode  
**1**

Submode  
**1**

Data No.  
**46**

PC Programming  
 + BA

























## General Description

Use this Memory Block to assign a 1-digit number as an Access Code or station number.

## Display

Data No.	Title	Dial No. 0-9 * #	Function No.
46	: 1 D G	( 0 ) =	0 8 0
T I M E      D I S P L A Y			



## Programming Procedures

<b>1</b>	Go off-line.																					
<b>2</b>	Press LK1 + LK1 +   to access the Memory Block.																					
<b>3</b>	Enter the options using the dial pad. <b>Note:</b> Use the following when entering data:  to move the cursor left  to move the cursor right  to enter numeric data																					
	<b>Default Values</b> <table border="1" style="width: 100%; border-collapse: collapse; margin-top: 10px;"> <thead> <tr> <th style="width: 15%;">Dial No.</th> <th style="width: 15%;">Function No.</th> <th style="width: 70%;">Function Name</th> </tr> </thead> <tbody> <tr> <td style="text-align: center;"></td> <td style="text-align: center;">080</td> <td style="text-align: center;">Outgoing CO in same Tenant</td> </tr> <tr> <td style="text-align: center;"></td> <td style="text-align: center;">001</td> <td style="text-align: center;">Station Number</td> </tr> <tr> <td style="text-align: center;"></td> <td style="text-align: center;">000</td> <td style="text-align: center;">Not Used</td> </tr> <tr> <td style="text-align: center;"></td> <td style="text-align: center;">176</td> <td style="text-align: center;">Specified Station Access 00</td> </tr> <tr> <td style="text-align: center;"></td> <td style="text-align: center;">095</td> <td style="text-align: center;">Speed Dial Call</td> </tr> <tr> <td style="text-align: center;"></td> <td style="text-align: center;">096</td> <td style="text-align: center;">Last Number Redial</td> </tr> </tbody> </table>	Dial No.	Function No.	Function Name		080	Outgoing CO in same Tenant		001	Station Number		000	Not Used		176	Specified Station Access 00		095	Speed Dial Call		096	Last Number Redial
Dial No.	Function No.	Function Name																				
	080	Outgoing CO in same Tenant																				
	001	Station Number																				
	000	Not Used																				
	176	Specified Station Access 00																				
	095	Speed Dial Call																				
	096	Last Number Redial																				
<b>4</b>	Enter the Function Number for the Dial Number. Refer to the table on the following pages for a complete list.																					
<b>5</b>	Press  to write the data. The next Access Code is displayed.																					
<b>6</b>	Press  to go back on-line.																					

## Related Programming

M.B. Number	Memory Block Name
<b>1-1-47</b>	Access Code (2-Digit) Assignment
<b>1-1-48</b>	Access Code (3-Digit) Assignment

# N

1. Select options from the list of function numbers in Memory Block 1-1-46 Access Code (1-Digit) Assignment, and assign a number (from 0~9), \*, or # to each selected function.
  - When a function is assigned a 1-digit Access Code, 2-digit Access Codes with the same first digit become invalid (*i.e.*, if a function is assigned to Access Code 5, Access Codes 50~59, 5\*, and 5# cannot be used.)
2. To enter # or \* as part of an Access Code, press  then  or .
3. This Memory Block is used when a 2- or 3-Digit Station Numbering Plan is programmed.
4. LCR must always use trunk group 1 Access Code.
5. When 4 digit extension numbering plan is used dial numbers 1~8 should be assigned as 000 (not used). Assignment of extension number range is done in Memory Block 1-1-47, e.g. 1-1-46:
  - 0 = 080 1~8 = 000
  - 9 = 176
  - \* = 095
  - # = 096
 4 digit extension range required is 4000~4100  
 Memory Block 1-1-47  
 40 = 001 and 41 = 001.  
 It is then possible to use Memory Block 4-10 Station Number Assignment.
6. Call Forward Off Premise uses the same access codes as Internal Call Forward, however a Trunk Access Code is entered instead of an Extension.

This table applies to Data Numbers 46, 47, and 48.

#### Default Dial Numbers and Function Numbers

Default Dial No.	Function No.	Function Name
4, 5, 6, 7, 8	000	Not Used
1, 2, 3	001	Station Number
	002	Not Used
	}	}
	019	Not Used
	020	Call Forward No Answer Set
	021	Call Forward No Answer Cancel
	022	Call Forward Busy Set
	023	Call Forward Busy Cancel
43	024	Call Forward Busy/No Answer Set
44	025	Call Forward Busy/No Answer Cancel
	026	Callback Message Answer
6#	027	SLT Hookflash
	028	Not Used
	029	Not Used
41	030	Call Forward All Call Set
40	031	DND Set
42	032	Call Forward All Call/DND Cancel
	033	Call Forward All Call Set from Destination
	034	Call Forward All Call Cancel from Destination
	035	Station Outgoing Lockout Set
	036	Station Outgoing Lockout Cancel
	037	Change Password
	038	Reset Password from Attendant
	039	Fax Status Indication (Tie/DID lines)
	040	Log - ON/OFF
	041	Account Code Entry
67	042	Call Pickup Direct
	043	Not Used
	044	Timed Alarm Set at SLTs
	045	Timed Alarm Cancel at SLTs
	046	Set and Cancel of Timed Alarm for Single Line Telephone from Attendant

#### Default Dial Numbers and Function Numbers

Default Dial No.	Function No.	Function Name
4*	047	Call Park System Transfer
4#	048	Call Park System Answer
60	049	Volume/LCD Control
	050	Specified Tenant on CO/PBX/Centrex Line Seizure (1-digit)
	051	Specified Tenant on CO/PBX/Centrex Line Seizure (2-digit)
	052	Call Pickup CO/PBX by Tenant (1-digit)
	053	Call Pickup CO/PBX/Centrex by Tenant (2-digit)
	054	Specified Tenant Internal Paging (1-digit)
	055	Specified Tenant Internal Paging (2-digit)
	056	Internal Emergency All Call Paging
68	057	Intra-Tenant Call Pickup
69	058	Night Chime Call Pickup
	059	Not Used
	060	Call Pickup CO/PBX for other Tenants
	061	Internal/CO/PBX Transfer Call Pickup in Same Tenant
	062	SLT Park to Non-Exclusive Hold
	063	Specified CO/PBX/Centrex Line Seizure (1-digit)
	064	Specified CO/PBX/Centrex Line Seizure (2-digit)
	065	Call Pick-Up Group
6*	066	Call Pickup CO/PBX in Same Tenant
	067	Call Pickup (Tie only) in Same Tenant
	068	Call Pickup (PBX only) in Same Tenant
	069	Call Pickup (CO only) in Same Tenant
51	070	All Internal Zone Paging
52	071	Internal Zone A Paging
53	072	Internal Zone B Paging
54	073	Internal Zone C Paging

**Default Dial Numbers and Function Numbers**

Default Dial No.	Function No.	Function Name
5*	074	Internal/External Meet-Me
55	075	All External Zone Paging
56	076	External Zone A Paging
57	077	External Zone B Paging
58	078	External Zone C Paging
5#	079	External Meet-Me
0	080	Outgoing (CO only) Access in Same Tenant
59	081	All Internal/External Zone Paging
	082	System I. D. Number for Tie Line Networking
	083	PHS Location Registration
	084	PHS Call Authentication
	085	Not Used
	086	Tie Line Seizure in Same Tenant
	087	PBX Line Seizure in Same Tenant
78	088	Trunk Queuing Set
79	089	Trunk Queuing Cancel
76	090	Station Speed Dial Programming (Single Line Telephone)
	091	Doorphone 1 Call
	092	Doorphone 2 Call
	093	Doorphone 3 Call
	094	Doorphone 4 Call
*	095	Station/System Speed Dial Call (Single Line Telephone)
#	096	Last Number Redial
	097	Not Used
88	098	DSS 1 CALL
89	099	DSS 2 CALL
	100	Not Used
81	101	Trunk Group 01
82	102	Trunk Group 02
83	103	Trunk Group 03
84	104	Trunk Group 04
85	105	Trunk Group 05

**Default Dial Numbers and Function Numbers**

Default Dial No.	Function No.	Function Name
	106	Trunk Group 06
	∅	∅
	132	Trunk Group 32
	133	Not Used
	∅	∅
	139	Not Used
45	140	Call Forward Busy/No Answer Set for Call Arrival Key
46	141	Call Forward Busy/No Answer Cancel for Call Arrival Key
47	142	Call Forward All Call Set for Call Arrival Key
48	143	Call Forward All Call Cancel for Call Arrival Key
	144	Call Forward All Split set for CAR
	145	Call Forward All Split cancel for CAR
	146	Forced Account Code Programming
	147	Forced Account Code Access
	148	Station Relocation
	150	Call Forward No Answer Split Set
	151	Call Forward No Answer Split Cancel
	152	Call Forward Busy Split Set
	153	Call Forward Busy Split Cancel
	154	Call Forward Busy/No Answer Split Set
	155	Call Forward Busy/No Answer Split Cancel
	156	Call Forward All Split Set
	157	Call Forward All Split Cancel
	158	Call Forward Busy/No Answer Split Set for CAR
	159	Call Forward Busy/No Answer Split Cancel for CAR
	∅	∅
	175	Not Used
9	176	Specified Station Access Code 00

Default Dial Numbers and Function Numbers

Default Dial No.	Function No.	Function Name
	177	Specified Station Access Code 01
	178	Specified Station Access Code 02
	179	Specified Station Access Code 03
	180	Specified Station Access Code 04
	181	Specified Station Access Code 05
	182	Specified Station Access Code 06
	183	Specified Station Access Code 07
	184	Specified Station Access Code 08
	185	Specified Station Access Code 09
	186	Specified Station Access Code 10
	187	Specified Station Access Code 11
	188	Specified Station Access Code 12
	189	Specified Station Access Code 13
	190	Specified Station Access Code 14
	191	Specified Station Access Code 15
	192	Specified Station Access Code 16
	193	Specified Station Access Code 17
	194	Specified Station Access Code 18
	195	Specified Station Access Code 19
	196	Specified Station Access Code 20
	197	Specified Station Access Code 21
	198	Specified Station Access Code 22
	199	Specified Station Access Code 23
	200	Not Used
	201	Route Advance Block 01

Default Dial Numbers and Function Numbers

Default Dial No.	Function No.	Function Name
	?	?
	232	Route Advance Block 32
	233	Not Used
	?	?
	250	ID Call Originate
	251	DISA/ID Password Set (Any station)
	252	DISA/ID Password Reset (Attendant only)
	253	DISA/ID Password Confirmation (Attendant only)
	254	Not Used
	255	Not Used
	301	Third Digit Table Number 01 (2-digit Numbering Plan can only be entered.)
	?	?
	304	Third Digit Table Number 04 (2-digit Numbering Plan can only be entered.)
	401	Closed Number Block 1
	?	?
	416	Closed Number Block 16
	501	VRS Voice Message Record/Verify/Erase (Voice Prompt, Automated Attendant)
	502	Voice Mail Message Set
	503	Voice Mail Message Cancel
	601	ACR Table 1
	602	ACR Table 2
	603	ACR Table 3
	604	ACR Table 4



# Access Code (2-Digit) Assignment

System Mode  
1

Submode  
1

Data No.  
47

PC Programming



## General Description

Use this Memory Block to assign a 2-digit number as an Access Code.

## Display

Data No.	Title	Dial No. 0-9 * #	Function No.
47	: 2 D G	( 0 0 )	= 0 0 0
T I M E D I S P L A Y			

## Programming Procedures

1	Go off-line.	
2	Press LK1 + LK1 +   to access the Memory Block.	
3	Enter the options using the dial pad. <b>Note:</b> Use the following to enter data: <ul style="list-style-type: none"> <li> to move the cursor left</li> <li> to move the cursor right</li> <li> ~  to enter numeric data</li> </ul>	<b>Default Values</b> Refer to Table in MB 1-1-46 Access Code (1-Digit) Assignment
4	Enter the Function Number for the Dial Number. Refer to the table in Memory Block 1-1-46 Access Code (1-Digit) Assignment.	
5	Press  to display next dial number successively.	
6	Dial 00, and press  to display next data.	
7	Press  to write selected data.	
8	Press  to go back on-line.	

## Related Programming

M.B. Number	Memory Block Name
1-1-46	Access Code (1-Digit) Assignment
1-1-48	Access Code (3-Digit) Assignment

# N

1. Select options from the list of function numbers in Memory Block 1-1-46 Access Code (1-Digit) Assignment, and assign a number (from 00~99), \*, or # to each selected function.
  - When a function is assigned a 1-digit Access Code, 2-digit Access Codes with the same first digit become invalid (i.e., if a function is assigned to Access Code 5, Access Codes 50~59, 5\*, and 5# cannot be used.)
2. To enter # or \* as part of an Access Code, press then or .
  - Use this Memory Block when a 4-Digit Station Numbering Plan is programmed.
3. Use this Memory Block when a 4-Digit Station Numbering Plan is programmed.

# Access Code (3-Digit) Assignment

System Mode  
**1**

Submode  
**1**

Data No.  
**48**

PC Programming  
 + BA







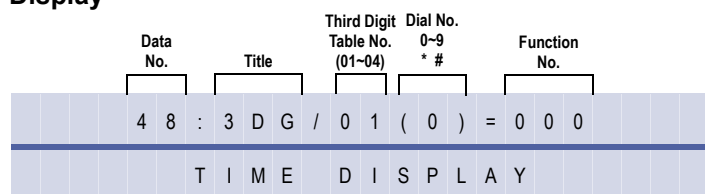





## General Description

Use this Memory Block to assign a 3-digit number as an Access Code.

## Display



## Programming Procedures

<b>1</b>	Go off-line.	
<b>2</b>	Press LK1 + LK1 +   to access the Memory Block.	
<b>3</b>	Enter the function code data using the dial pad. <b>Note:</b> Use the following to enter data: <ul style="list-style-type: none"> <li> to move the cursor left</li> <li> to move the cursor right</li> <li> ~  to enter numeric data</li> <li> +  to enter *</li> <li> +  to enter #</li> </ul>	<b>Default Values</b> All Dial 000 (Not Used)
<b>4</b>	Press  to write the data. The next dial number data is displayed.	
<b>5</b>	After last entry, press  to write the data.	
<b>6</b>	Enter Function No. for Dial No. 0, and press  to write the data and display the next Dial No.	

## Related Programming

M.B. Number	Memory Block Name
<b>1-1-46</b>	Access Code (3-Digit) Assignment
<b>1-1-47</b>	Access Code (2-Digit) Assignment

# N

1. Select options from the list of function numbers in Memory Block 1-1-46 Access Code (1-Digit) Assignment, and assign a 3-digit Access Code.
  - When a function is assigned a 1-digit Access Code or 2-digit Access Code, 3-digit Access Codes (with the same first digit) become invalid (*i.e.*, if a function is assigned to Access Code 5, Access Codes 50~59, 5\*, and 5# cannot be used.)
2. A station number is not assigned in this Memory Block.
3. All items except function number 001 (Station Number) in 1-digit assignment are valid in this block.
4. Four groups of Access Code Tables can be used. 0~9, \*, and # are the third digit Access Codes that are assigned in the third digit tables.
5. Before using this function, assign function numbers 301~304 (Table No. for third digit) in Memory Block 1-1-47 Access Code (2-Digit) Assignment.
6. To program Access Code 811 for Trunk Group 02:
  - Use Memory Block 1-1-47 Access Code (2-Digit) Assignment to assign function 301 to 81.
  - Set 3rd digit Table No. 01 dial number 1 to function 102.

Numbering Plan (2-Digit)

Dial No.	Function Number
81	301(3rd Dgt Table 01)
82	302(3rd Dgt Table 02)
83	303(3rd Dgt Table 03)
84	304(3rd Dgt Table 04)

Numbering Plan (3-Digit)3rd Digit Table No. 01

Dial No.	Function Number
0	101 (Trunk Group 01)
1	102 (Trunk Group 02)
2	103 (Trunk Group 03)
3	104 (Trunk Group 04)
4	105 (Trunk Group 05)
:	:
9	110 (Trunk Group 10)

# Networking Trunk Group/ Route Advance Assignment

*System Mode*  
**1**

*Submode*  
**1**

*Data No.*  
**49**

*PC Programming*  
 + **BCS**







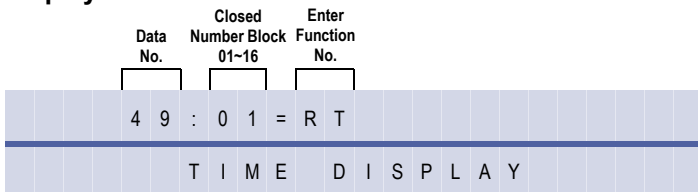

## General Description

Use this Memory Block to assign the function number of the Trunk Group to be used to network an Xen system to another system by Tie lines or CO/PBX/CTX lines.

## Display



## Programming Procedures

<b>1</b>	Go off-line.
<b>2</b>	Press LK1 + LK1 +   to access the Memory Block.
<b>3</b>	Use dial pad to enter the Function Number of the Trunk Group or the Route Advance Block. <span style="float: right;"><b>Default Values</b> Not Specified</span>
	<p><b>Note:</b> Use the following to enter data:</p> <ul style="list-style-type: none"> <li> to move the cursor left</li> <li> to move the cursor right</li> <li> ~  to enter numeric data</li> <li> to clear all data</li> </ul>
<b>4</b>	Press  to write selected data.
<b>5</b>	Press  to go back on-line.

## Related Programming

M.B. Number	Memory Block Name
<b>1-1-30</b>	Route Advance Block Assignment
<b>3-03</b>	Trunk-to-Trunk Group Assignment
<b>1-1-50</b>	CO/PBX Outgoing Digit Add Assignment



Function Number 101~132 (Trunk Group 1~32, respectively) or 201~216 (Route Advance Block 1~16, respectively) is assigned to Closed Number blocks.

# CO/PBX Outgoing Digit Add Assignment

## General Description

Use this Memory Block to specify up to 10 additional digits when a trunk in the Trunk Group or Route Advance block assigned in Memory Block 1-1-49 Networking Trunk Group/Route Advance Assignment is seized, and a number is dialled.

## Display

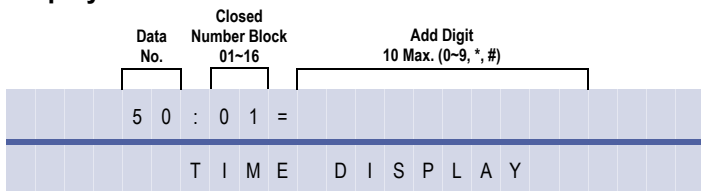













System Mode  
**1**

Submode  
**1**

Data No.  
**50**

PC Programming  
 + BCS

## Programming Procedures

<b>1</b>	Go off-line.	
<b>2</b>	Press LK1 + LK1 +   to access the Memory Block.	
<b>3</b>	Use dial pad to enter digits to be added. <b>Note:</b> Use the following to enter data: <ul style="list-style-type: none"> <li> to move the cursor left</li> <li> to move the cursor right</li> <li> ~  to enter numeric data</li> <li> to clear all data</li> <li> +  to enter *</li> <li> +  to enter #</li> </ul>	<b>Default Values</b> Not Specified
<b>4</b>	Press  to write selected data.	
<b>5</b>	Press  to go back on-line.	

## Related Programming

M.B. Number	Memory Block Name
<b>1-1-46</b>	Access Code (3-Digit) Assignment
<b>1-1-49</b>	Networking Trunk Group/Route Advance Assignment

N

Example:

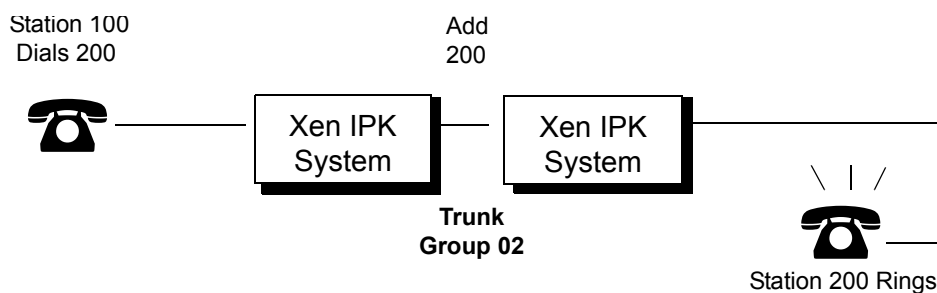

*To assign System 1 in System Programming:*

1. Memory Block 1-1-46 Access Code (1-Digit) Assignment. Assignment 2 → 401 (Closed Number Block 01).
2. Memory Block 1-1-49 Networking Trunk Group/Route Advance Assignment. Assignment Block 01 → 102 (Trunk Group 02).
3. Memory Block 1-1-50 CO/PBX Outgoing Digit Add Assignment. Assignment Block 01 → Assign 2
4. Digits are added when the Access Code is dialed from the internal dial tone.
5. This Memory Block also applies to ISDN trunks.

# CO Line Ringing Pattern Selection

## General Description

Use this Memory Block to assign the initial ringing pattern for incoming calls on a CO line.

## Display

Data No.	Title	Setting Data	Page No.
5 1	: C O P T N	G	1
T I M E D I S P L A Y			

## Settings

LK 1	LK 2	LK 3	LK 4
Ring Pattern A	Ring Pattern B	Ring Pattern C	Ring Pattern D
LK 5	LK 6	LK 7	LK 8
Ring Pattern E	Ring Pattern F	Ring Pattern G	Ring Pattern H

The shaded area indicates the default setting.

LK 9	LK 10	LK 11	LK 12
No ring			
LK 13	LK 14	LK 15	LK 16

## Programming Procedures

1	Go off-line.
2	Press LK1 + LK1 +   to access the Memory Block.
3	Press corresponding CO/PBX line key to change data. <b>Note:</b> Use the following to enter data: to access the next page to access the previous page
4	Press  to write data.
5	Press  to go back on-line.

## Related Programming

M.B. Number	Memory Block Name
1-1-59	Synchronous Ringing Selection

System Mode  
**1**

Submode  
**1**

Data No.  
**51**

PC Programming  
 + BCS

The Ring Patterns are shown in the table below:

s= seconds

Pattern	0s	1s	2s	3s	4s	5s	6s
A							
B							
C							
D							
E							
F							
G							
H							
NIL	No Ring						



# PBX Line Ringing Pattern Selection

## General Description

Use this Memory Block to assign the initial ringing pattern for incoming calls on a PBX line.

## Display

Data No.	Title	Setting Data	Page No.
5 2	: P B X P T N	B	1
T I M E D I S P L A Y			

*System Mode*  
**1**  
*Submode*  
**1**  
*Data No.*  
**52**  
*PC Programming*  
 + **BCS**

## Settings

(Page 1)







LK 1	LK 2	LK 3	LK 4
Ring Pattern A	Ring Pattern B	Ring Pattern C	Ring Pattern D
LK 5	LK 6	LK 7	LK 8
Ring Pattern E	Ring Pattern F	Ring Pattern G	Ring Pattern H

(Page 2)

LK 9	LK 10	LK 11	LK 12
No Ring			
LK 13	LK 14	LK 15	LK 16

The shaded area indicates the default setting.

## Programming Procedures

1	Go off-line.
2	Press LK1 + LK1 +   to access the Memory Block.
3	Press corresponding CO/PBX line key to change data. <b>Note:</b> Use the following to enter data:  to access the next page  to access the previous page
4	Press  to write data.
5	Press  to go back on-line.

## Related Programming

No related programming is necessary for this Memory Block.

# N

Do not program this Memory Block if Memory Block 1-1-59 Synchronous Ringing Selection is assigned Yes.

The Ring Patterns are listed in the table below:

s= seconds

Pattern	0s	1s	2s	3s	4s	5s	6s
A							
B							
C							
D							
E							
F							
G							
H							
NIL	No Ring						

# Tie Line Delay Ring Pattern Selection

## General Description

Use this Memory Block to select a ringing pattern for incoming calls on a Tie line after the timeout set in Memory Block 1-1-07.

## Display

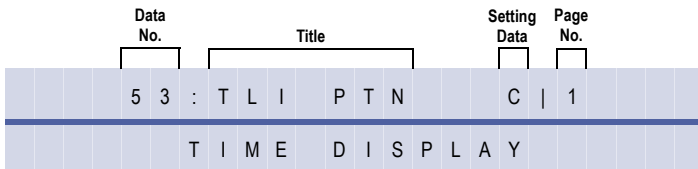

## Settings

(Page 1)

LK 1	LK 2	LK 3	LK 4
Ring Pattern A	Ring Pattern B	Ring Pattern C	Ring Pattern D
LK 5	LK 6	LK 7	LK 8
Ring Pattern E	Ring Pattern F	Ring Pattern G	Ring Pattern H

(Page 2)

LK 9	LK 10	LK 11	LK 12
No Ring			
LK 13	LK 14	LK 15	LK 16

The shaded area indicates the default setting.

## Programming Procedures

- 1 Go off-line.
- 2 Press LK1 + LK1 + to access the Memory Block.
- 3 Press the corresponding CO/PBX line key to change the data option.  
**Note:** Use the following to enter data:  
 to access the next page  
 to access the previous page
- 4 Press data.
- 5 Press to go back on-line.

## Related Programming

M.B. Number	Memory Block Name
1-1-07	Tie Line Delay Ringing Timer Selection
1-1-34	Tie Line First Ring Pattern Selection
4-01	CO/PBX Ring Assignment (Day Mode)
4-02	CO/PBX Ring Assignment (Night Mode)

System Mode  
1

Submode  
1

Data No.  
53

PC Programming  
 + ALN

The Ring Patterns are shown in the table below:

**s= seconds**

Pattern	0s	1s	2s	3s	4s	5s	6s
A							
B							
C							
D							
E							
F							
G							
H							
NIL	No Ring						

# Automated Attendant Transfer Ring Pattern

## General Description

Use this Memory Block to specify the ringing pattern sent to the Multiline Terminal when an incoming call is received at the Automated Attendant and transferred.

## Display

Data No.	Title	Setting Data	Page No.
5 4	: A A P T N	C	1
T I M E D I S P L A Y			

System Mode  
**1**

Submode  
**1**

Data No.  
**54**

PC Programming  
 + AU

## Settings

(Page 1)







LK 1	LK 2	LK 3	LK 4
Ring Pattern A	Ring Pattern B	Ring Pattern C	Ring Pattern D
LK 5	LK 6	LK 7	LK 8
Ring Pattern E	Ring Pattern F	Ring Pattern G	Ring Pattern H

(Page 2)

LK 9	LK 10	LK 11	LK 12
No Ring			
LK 13	LK 14	LK 15	LK 16

The shaded area indicates the default setting.

## Programming Procedures

1	Go off-line.
2	Press LK1 + LK1 +   to access the Memory Block.
3	Press the corresponding CO/PBX line key to change the data option. <b>Note:</b> Use the following to enter data:  to access the next page  to access the previous page
4	Press  to write the data.
5	Press  to go back on-line.

## Related Programming

M.B. Number	Memory Block Name
	Refer to <i>Chapter 2 Guide to Feature Programming</i> .

The Ring Patterns are shown in the table below:

s= seconds

Pattern	0s	1s	2s	3s	4s	5s	6s
A							
B							
C							
D							
E							
F							
G							
H							
NIL	No Ring						

# DID Line Ringing Pattern Selection

## General Description

This Memory Block assigns the ringing pattern to be used for DID calls.

## Display

Data No.	Title	Setting Data	Page No.
5 5	: D I D P T N	C	1
T I M E D I S P L A Y			

System Mode  
**1**

Submode  
**1**

Data No.  
**55**

PC Programming

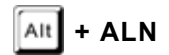

## Settings

LK 1	LK 2	LK 3	LK 4
Ring Pattern A	Ring Pattern B	Ring Pattern C	Ring Pattern D
LK 5	LK 6	LK 7	LK 8
Ring Pattern E	Ring Pattern F	Ring Pattern G	Ring Pattern H

The shaded area indicates the default setting.

LK 9	LK 10	LK 11	LK 12
No ring			
LK 13	LK 14	LK 15	LK 16

## Programming Procedures

1	Go off-line.
2	Press LK1 + LK1 +   to access the Memory Block.
3	Press the corresponding CO/PBX line key to change the data option. <b>Note:</b> Use the following to change page: to move to next page to move to previous page
4	Press  to write the data.
5	Press  to go back on-line.

## Related Programming

M.B. Number	Memory Block Name
1-1-20	DID Digit Length Selection
1-1-21	DID Digit Conversion Assignment
1-1-22	DID Digit Conversion Table & DNIS Assignment

# CO/PBX Prepause Timer Selection

System Mode  
**1**

Submode  
**1**

Data No.  
**57**

PC Programming  
 + BCM

## General Description

Use this Memory Block to assign a pause time before dialled digits can be sent over a CO/PBX line after the trunk is seized by a system user.

## Display

Data No.	Title	Setting Data	Page No.
57	PREPAUSE	3 s	1
TIME DISPLAY			

## Settings

### (Page 1)







LK 1	LK 2	LK 3	LK 4
None	1 sec.	2 sec.	3 sec.
LK 5	LK 6	LK 7	LK 8
4 sec.	5 sec.	6 sec.	7 sec.

### (Page 2)

LK 1	LK 2	LK 3	LK 4
8 sec.	9 sec.	10 sec.	11 sec.
LK 5	LK 6	LK 7	LK 8
12 sec.	13 sec.		

The shaded area indicates the default setting.

## Programming Procedures

1	Go off-line.
2	Press LK1 + LK1 +   to access the Memory Block.
3	Press the corresponding CO/PBX line key to change the data option. <b>Note:</b> Use the following to change page:  to move to next page  to move to previous page
4	Press  to write the data.
5	Press  to go back on-line.

## Related Programming

No related programming is necessary for this Memory Block.



# Synchronous Ringing Selection

## General Description

Use this Memory Block to specify whether or not CO/PBX calls follow Synchronous Ringing.

## Display

Data No.	Title	Function No.
59	SYNCHRONOUS	YS
	TIME DISPLAY	

## Settings

LK 1	LK 2	LK 3	LK 4
Yes	No		
LK 5	LK 6	LK 7	LK 8

The shaded area indicates the default setting.

## Programming Procedures

1	Go off-line.
2	Press LK1 + LK1 +   to access the Memory Block.
3	Press the corresponding CO/PBX line key to change the data option.
4	Press  to write the data.
5	Press  to go back on-line.

## Related Programming

No related programming is necessary for this Memory Block.

System Mode

1

Submode

1

Data No.

59

PC Programming

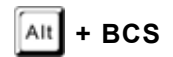

## N

1. Synchronous Ringing does not apply to incoming DID calls, off-hook ringing calls, or CO/PBX ring transfer calls.
2. Do not program this Memory Block if Memory Block 1-1-59 Synchronous Ringing Selection is assigned Yes.

# 8-Digit Matching Table Assignment

System Mode  
**1**

Submode  
**1**

Data No.  
**60**

PC Programming  
 + AC

## General Description







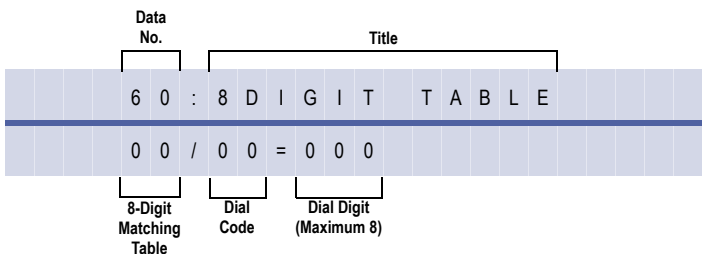































































Use this Memory Block to assign the outgoing dial digit for Code Restriction (except OCC Dial Digit - Normal Dial). Program this assignment in one of two ways:

- a) When the user dials digit(s) and there is a match, the system allows free dialling or denies dialling by disconnecting. Refer to Memory Block 1-1-61, 8-Digit Matching Table to Class Assignment for programming.
- b) When a user dials digit(s) and there is no match, the system allows free dialling or denies dialling by disconnecting. Refer to Memory Block 1-1-65, Code Restriction Class Allow/Deny Selection for programming.

## Display



## Programming Procedures

<b>1</b>	Go off-line.																			
<b>2</b>	Press LK1 + LK1 +   to access the Memory Block.																			
<b>3</b>	Use the dial pad to enter the data. <b>Note:</b> Use the following to enter data:  to move the cursor left  to move the cursor right  ~  to enter numeric data  to clear data  The information that can be entered includes: Matching Table:                   00~15 (8-digit) Dial Code:                           00~15 Dial Digit:                           0~9, *, #, X, P, N (Maximum eight digits)	<b>Default Values</b> <table border="1" style="width: 100%; border-collapse: collapse; text-align: center;"> <thead> <tr> <th style="width: 33%;">Matching Table</th> <th style="width: 33%;">Dial Code</th> <th style="width: 33%;">Setting Data</th> </tr> </thead> <tbody> <tr> <td rowspan="2">00</td> <td>00</td> <td>000</td> </tr> <tr> <td>01</td> <td>1144x</td> </tr> </tbody> </table>	Matching Table	Dial Code	Setting Data	00	00	000	01	1144x										
Matching Table	Dial Code	Setting Data																		
00	00	000																		
	01	1144x																		
<b>4</b>	Operation data includes: <table border="1" style="width: 100%; border-collapse: collapse; text-align: center;"> <thead> <tr> <th style="width: 20%;">Operation Data</th> <th style="width: 40%;">Dial Number</th> <th style="width: 40%;">Operation</th> </tr> </thead> <tbody> <tr> <td>X</td> <td> ~ , , </td> <td> + </td> </tr> <tr> <td>P</td> <td> and </td> <td> + </td> </tr> <tr> <td>N</td> <td> ~ </td> <td> + </td> </tr> <tr> <td>*</td> <td></td> <td> + </td> </tr> <tr> <td>#</td> <td></td> <td> + </td> </tr> </tbody> </table>	Operation Data	Dial Number	Operation	X	 ~  ,  , 	 + 	P	 and 	 + 	N	 ~ 	 + 	*		 + 	#		 + 	
Operation Data	Dial Number	Operation																		
X	 ~  ,  , 	 + 																		
P	 and 	 + 																		
N	 ~ 	 + 																		
*		 + 																		
#		 + 																		
<b>5</b>	Press  to write the data and advance to the next dial code. After all dial codes have been entered, press  again.																			
<b>6</b>	Press  to go back on-line.																			

Doc. No.: 8194 - Release 2.0  
December 2004

**Related Programming**

M.B. Number	Memory Block Name
	Refer to <i>Section 6 Code Restriction</i> in this chapter.

**N**

There are sixteen 8-Digit Matching Tables. Each 8-digit table contains 16 Dial Codes. Each dial code can have eight characters including digits and/or \*, #, X, P, or N characters.

# 8-Digit Matching Table to Class Assignment

## General Description

Use this Memory Block to program, per Class, each 8-digit Matching Table to allow or deny. Classes 00 and 15 are fixed. Only classes 01~14 can be programmed.

## Display

Data No.	Title 1~7	Class No. 01~14	Table 00~15	Setting Data
6 1	: C L S	0 1	( 0 0 ) =	Y S
T I M E D I S P L A Y				

System Mode  
**1**

Submode  
**1**

Data No.  
**61**





PC Programming  
 + AC

## Settings

LK 1	LK 2	LK 3	LK 4
NON	Allow (YS)	Deny (NO)	
LK 5	LK 6	LK 7	LK 8

The shaded area indicates the default setting.

## Programming Procedures

- 1 Go off-line.
- 2 Press LK1 + LK1 +   to access the Memory Block.
- 3 Press the corresponding CO/PBX line key to change the data option.  
**Note:** Class 00 and 15 cannot be programmed.  
Class 00 has no restrictions (Allow)  
Class 15 has restricted outgoing (Deny)  
Refer to the table on the next page.
- 4 Press  to write the data and advance to the next table. Repeat Steps 3 and 4 for each table.
- 5 After data for the last table is entered, press  to write the data.
- 6 Press  to go back on-line.

## Related Programming

M.B. Number	Memory Block Name
	Refer to <i>Section 6 Code Restriction</i> in this chapter.

Table	0	1	2	3	4	5	6	7	8	9	10	11	12	13	14	15
<b>Class</b>																
01	A															
02	A															
03	A															
04	A															
05	A															
06	A															
07	A															
08	A															
09	A															
10	A															
11	A															
12	A															
13	A															
14	A															

**A = Allow**

**D = Deny**

# System Speed Dial Override by Class Selection

## General Description

Use this Memory Block to specify, per Class, whether or not a user can override System Speed Dial.

## Display

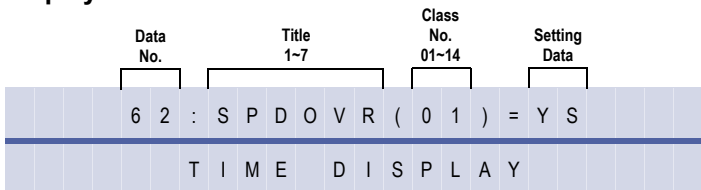

System Mode  
**1**

Submode  
**1**

Data No.  
**62**

PC Programming  
 + AC

## Settings

LK 1	LK 2	LK 3	LK 4
NO No Override	YS Override		
LK 5	LK 6	LK 7	LK 8

The shaded area indicates the default setting.

## Programming Procedures

- 1 Go off-line.
- 2 Press LK1 + LK1 + to access the Memory Block.
- 3 Press the corresponding CO/PBX line key to change the data option.
- 4 Press to write the data and advance to the next class. Repeat Steps 3 and 4 for each class.
- 5 After data for the last class is entered, press to write the data.
- 6 Press to go back on-line.

## Related Programming

M.B. Number	Memory Block Name
1-1-18	System Speed Dial Restriction by Tenant



At system default, all stations are set to Class 00 to allow override for System Speed Dial.

# Hold Recall Time Selection (Exclusive)

## General Description

Use this Memory Block to specify the time for Exclusive Hold Recall. If No Limit is selected, Exclusive Hold Recall is not provided.

With IPK R2000 and above, this memory block allows flexible entries and has four classes.

*For R2000 only.*

## Display

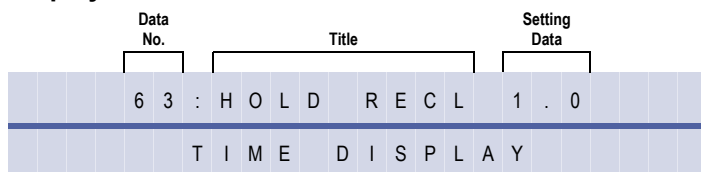

## Settings

LK 1	LK 2	LK 3	LK 4
0.5 min.	1 min.	1.5 min.	2 min.
LK 5	LK 6	LK 7	LK 8
3 min.	5 min.	8 min.	No Limit

The shaded area indicates the default setting.

## Programming Procedures

- 1 Go off-line.
- 2 Press LK1 + LK1 + to access the Memory Block.
- 3 Press the corresponding CO/PBX line key to change the data option.
- 4 Press to write the data.
- 5 Press to go back on-line.

*For R2000 and above.*

## Display

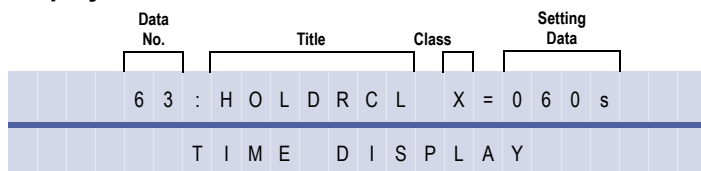

## Programming Procedures

- 1 Go off-line.
- 2 Press LK1 + LK1 + to access the Memory Block.

System Mode  
1



Submode  
1

Data No.  
63

PC Programming



**Programming Procedures** (Continued)

<b>3</b>	Use the dial pad to enter the time required. <i>Note:</i> * to move cursor left. # to move cursor right. Setting Data (Allow): Class 1 to Class 4: 000 to 999 sec Limit <span style="float: right;">000 = No</span>	Default values: Class 1 to Class 4 = 60 secs
<b>4</b>	Press  to write the data.	
<b>5</b>	Press  to go back on-line.	

**Related Programming**

M.B. Number	Memory Block Name
<b>1-1-03</b>	Hold Recall Timer Selection (Non Exclusive Hold)
<b>1-2-23</b>	System Call Park Recall Time Selection
<b>4-71</b>	Time Class Assignment for Telephone Mode (R2000 and above)

**N**

When an Exclusive Hold call recalls, the held call switches to a Non-Exclusive Hold call.



# Attendant Add-On Console Transfer/Camp-On Recall Timer Selection

System Mode  
**1**

Submode  
**1**

Data No.  
**64**

PC Programming



## General Description

Use this Memory Block to specify the time interval before a Ring Transfer or Station Camp-On from a station with an Attendant Add-On Console recalls back to the originating station if the call is not answered.

This memory block is removed with IPK R2000 and above.

## Display

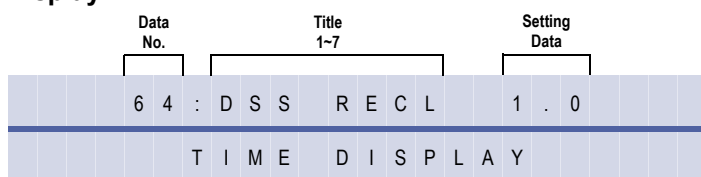

## Settings

LK 1	LK 2	LK 3	LK 4
0.5 min.	1 min.	1.5 min.	2 min.
LK 5	LK 6	LK 7	LK 8
3 min.	5 min.	8 min.	10 min.

The shaded area indicates the default setting.

## Programming Procedures

1	Go off-line.
2	Press LK1 + LK1 +   to access the Memory Block.
3	Press the corresponding CO/PBX line key to change the data option.
4	Press  to write the data.
5	Press  to go back on-line.

## Related Programming

M.B. Number	Memory Block Name
1-1-11	System Transfer/Camp-On Selection
1-1-12	Station Transfer/Camp-On Recall Timer Selection
1-6-00	Attendant Add-On Console to Telephone Port Assignment
1-8-08	Class of Service (Station) Feature Selection 2



- When a station without an assigned Attendant Add-On Console transfers or camps-on a call to a station that goes unanswered, the call recalls using Memory Block 1-1-12 Station Transfer/Camp-On Recall Timer Selection.
- Timer is valid only for stations assigned an Attendant Add-On Console in Memory Block 1-6-00 Attendant Add-On Console to Telephone Port Assignment. The key on the station and the console are both affected.

# Code Restriction Class Allow/ Deny Selection

System Mode  
**1**

Submode  
**1**

Data No.  
**65**

PC Programming  
 + AC

## General Description

Use this Memory Block to assign Code Restriction Classes 01~14 as Allow or Deny. This assignment is used when there is no match or there is an overlap (duplicate numbers in tables with opposite assignments) of numbers in the 8-Digit Matching Tables.

## Display





Data No.	Title	Class No. 01~14	Function
65	CLASS	(01)	YS
TIME DISPLAY			

## Settings

LK 1	LK 2	LK 3	LK 4
Allow (YS)	Deny (NO)		
LK 5	LK 6	LK 7	LK 8

The shaded area indicates the default setting.

## Programming Procedures

<b>1</b>	Go off-line.	
<b>2</b>	Press LK1 + LK1 +   to access the Memory Block.	
<b>3</b>	Press the corresponding CO/PBX line key to change data option.	<b>Default Values</b> Class 01      Deny (NO) Class 02~14    Allow (YES)
<b>4</b>	Press  to write the data and advance to the next class. Repeat steps 3 and 4 until last class is assigned.	
<b>5</b>	Press  to write selected data.	
<b>6</b>	Press  to go back on-line.	

## Related Programming

M.B. Number	Memory Block Name
	Refer to <i>Section 6 Code Restriction</i> in this chapter.

# N

1. If a match is not found or duplicate match is made with opposite assignments, the system uses this Memory Block.
2. If the interdigit dialling time duration exceeds 10 seconds while a restricted station user is dialling on an outside line, the system automatically drops the call.
3. If phones are required to dial emergency "only", then class 01 can be used.
4. Use Memory Block 1-1-70 as the default class assignment for features such as station outgoing lockout In/Out (from DSS console and password lockout).

# 8-Digit Matching Table to Normal Dial Assignment

System Mode  
1

Submode  
1

Data No.  
66

PC Programming



## General Description

Use this Memory Block to assign the 8-Digit Matching Table by class for normal dialling as used or unused. If unused is assigned, the system does not check during normal dialling even if Memory Block 1-1-61 8-Digit Matching Table to Class Assignment is programmed.

## Display

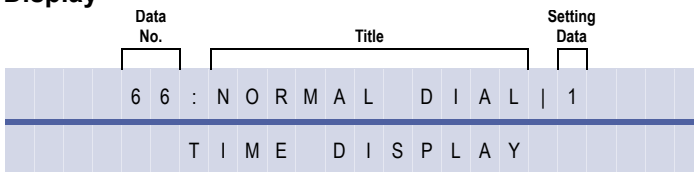

## Settings

(Page 1)

LK 1	LK 2	LK 3	LK 4
Table 00	Table 01	Table 02	Table 03
LK 5	LK 6	LK 7	LK 8
Table 04	Table 05	Table 06	Table 07

(Page 2)

LK 1	LK 2	LK 3	LK 4
Table 08	Table 09	Table 10	Table 11
LK 5	LK 6	LK 7	LK 8
Table 12	Table 13	Table 14	Table 15

There is no default setting.

## Programming Procedures

1	Go off-line.							
2	Press LK1 + LK1 +   to access the Memory Block.							
3	Press the corresponding CO/PBX line key to change data option. <b>Note:</b> Use the following to enter data: to access the next page. to access the previous page. Each time a CO/PBX line key is pressed, the LED toggles between On and Off.	<b>Default Values</b> Tables 00~15 Used						
	<table border="1" style="margin-left: auto; margin-right: auto;"> <tr> <td>CO/PBX Line LED</td> <td>Off</td> <td>On</td> </tr> <tr> <td>Data</td> <td>Restricted</td> <td>Not restricted</td> </tr> </table>	CO/PBX Line LED	Off	On	Data	Restricted	Not restricted	There is no default setting.
CO/PBX Line LED	Off	On						
Data	Restricted	Not restricted						
4	Press  to write the data and advance to the next class. Repeat steps 3 and 4 until last class is assigned.							
5	Press  to write the last data.							
6	Press  to go back on-line.							

## Related Programming

M.B. Number	Memory Block Name
	Refer to <i>Section 6 Code Restriction</i> in this chapter.

# OCC Table Assignment

System Mode  
**1**

Submode  
**1**

Data No.  
**67**

PC Programming  
 + AC







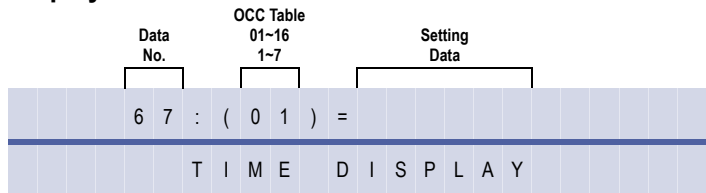































































## General Description

Use this Memory Block to assign an Other Common Carrier (OCC) code (8-digit maximum) in a table. A maximum of 16 codes can be assigned.

## Display



## Programming Procedures

1	Go off-line.																			
2	Press LK1 + LK1 +   to access the Memory Block.																			
3	Use the dial pad to enter the data. <b>Note:</b> Use the following to enter data:  to move the cursor left  to move the cursor right  ~  to enter numeric data  to clear data The information that can be entered includes: OCC Table: 01~16 (8-digit) Setting Data: 0~9, *, #, NANP = X, P, N (Maximum eight digits) Operation data includes:	<b>Default Values</b> Not specified																		
	<table border="1"> <thead> <tr> <th>Operation Data</th> <th>Dial Number</th> <th>Operation</th> </tr> </thead> <tbody> <tr> <td>X</td> <td> ~ , , </td> <td> + </td> </tr> <tr> <td>P</td> <td> and </td> <td> + </td> </tr> <tr> <td>N</td> <td> ~ </td> <td> + </td> </tr> <tr> <td>*</td> <td></td> <td> + </td> </tr> <tr> <td>#</td> <td></td> <td> + </td> </tr> </tbody> </table>	Operation Data	Dial Number	Operation	X	 ~  ,  , 	 + 	P	 and 	 + 	N	 ~ 	 + 	*		 + 	#		 + 	
Operation Data	Dial Number	Operation																		
X	 ~  ,  , 	 + 																		
P	 and 	 + 																		
N	 ~ 	 + 																		
*		 + 																		
#		 + 																		
4	Press  to write the data and advance to the next OCC table.																			
5	After all OCC data is entered, press  again.																			
6	Press  to go back on-line.																			

## Related Programming

M.B. Number	Memory Block Name
	Refer to <i>Section 6 Code Restriction</i> in this chapter.

# 8-Digit Matching Table to OCC Table Assignment

## General Description

Use this Memory Block to assign each 8-Digit Matching Table to each Other Common Carrier (OCC) Code Table.

## Display

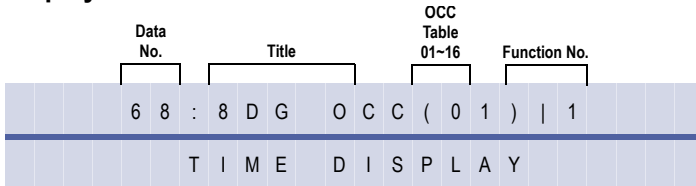

System Mode  
**1**

Submode  
**1**

Data No.  
**68**

PC Programming



## Settings

### (Page 1)

LK 1	LK 2	LK 3	LK 4
Table 00	Table 01	Table 02	Table 03
LK 5	LK 6	LK 7	LK 8
Table 04	Table 05	Table 06	Table 07

### (Page 2)

LK 1	LK 2	LK 3	LK 4
Table 08	Table 09	Table 10	Table 11
LK 5	LK 6	LK 7	LK 8
Table 12	Table 13	Table 14	Table 15

There is no default setting.

## Programming Procedures

1	Go off-line.							
2	Press LK1 + LK1 +   to access the Memory Block.							
3	Press the corresponding CO/PBX line key to change data option. <b>Note:</b> Use the following to enter data: to access the next page to access the previous page. Each time a CO/PBX line key is pressed, the LED toggles between On and Off.	<p><b>Default Values</b> OCC Tables 01~15: All Matching Tables Not Used OCC Table 16: Matching Tables 00~14 Not Used Matching Table 15 Used</p>						
	<table border="1"> <tr> <td>CO/PBX Line LED</td> <td>Off</td> <td>On</td> </tr> <tr> <td>Data</td> <td>Unused</td> <td>Used</td> </tr> </table>	CO/PBX Line LED	Off	On	Data	Unused	Used	There is no default setting.
CO/PBX Line LED	Off	On						
Data	Unused	Used						
4	Press  to write the data and advance to the next OCC table. Repeat steps 3 and 4 until last OCC data is assigned.							
5	Press  to write the last data.							
6	Press  to go back on-line.							

## Related Programming

M.B. Number	Memory Block Name
	Refer to <i>Section 6 Code Restriction</i> in this chapter.

# Tie Line Code Restriction Assignment

## General Description

Use this Memory Block to assign Restriction/No Restriction to outgoing Tie line dialled digits.

## Display

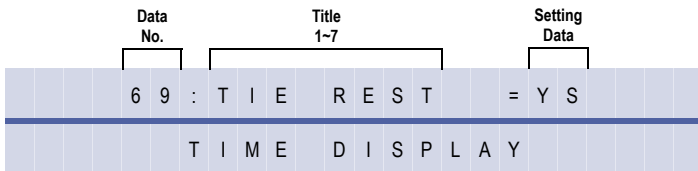





*System Mode*  
**1**  
*Submode*  
**1**  
*Data No.*  
**69**  
*PC Programming*  
 + AC

## Settings

LK 1	LK 2	LK 3	LK 4
No Restriction (NO)	Restriction (YS)		
LK 5	LK 6	LK 7	LK 8

The shaded area indicates the default setting.

## Programming Procedures

1	Go off-line.	
2	Press LK1 + LK1 +   to access the Memory Block.	
3	Press the corresponding CO/PBX line key to change data option.	<b>Default Values</b> Restriction
4	Press  to write the data.	
5	Press  to go back on-line.	

## Related Programming

M.B. Number	Memory Block Name
	Refer to <i>Section 6 Code Restriction</i> in this chapter.



When Tie lines are assigned code restriction, the Access Code used to dial out of the distant system must be entered in front of the dialled number in the 8-Digit Matching Tables.

# Code Restriction Class Assignment when Lockout is Set

System Mode  
1

Submode  
1

Data No.  
70

PC Programming  
 + AC







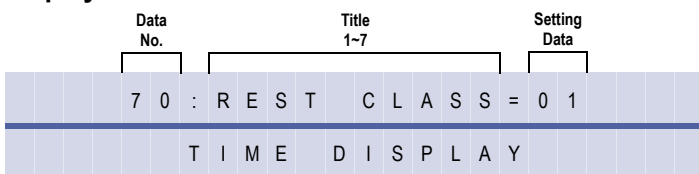

### General Description

Use this Memory Block to assign the Code Restriction Class when a station user sets the Station Lockout or when the Attendant sets Attendant Station Lockout.

### Display



### Programming Procedures

1	Go off-line.	
2	Press LK1 + LK1 +   to access the Memory Block.	
3	Used dial pad to enter class restriction. <b>Note:</b> Use the following to enter data:  to move the cursor left  to move the cursor right  ~  to enter numeric data	<b>Default Values</b> Class 01
4	Press  to write selected data.	
5	Press  to go back on-line.	

### Related Programming

M.B. Number	Memory Block Name
	Refer to <i>Section 6 Code Restriction</i> in this chapter.



When a station is locked out, the Code Restriction Class Assignment of this Memory Block is used instead of the Code Restriction Class assigned in Memory Block 4-07, Code Restriction Class Assignment (Day Mode) or 4-08, Code Restriction Class Assignment (Night Mode).

# First Delay Announcement Start Time Selection

## General Description

Use this Memory Block to specify the delay between receiving a CO call and sending a First Delay Announcement to the calling party.

## Display

Data No.	Title	Setting Data
7 1	MSG START	= 2 0
T I M E D I S P L A Y		

System Mode  
**1**

Submode  
**1**

Data No.  
**71**





PC Programming  
 + AR

## Settings

LK 1	LK 2	LK 3	LK 4
0 sec.	10 sec.	20 sec.	30 sec.
LK 5	LK 6	LK 7	LK 8
40 sec.	50 sec.	60 sec.	

The shaded area indicates the default setting.

## Programming Procedures

- 1 Go off-line.
- 2 Press LK1 + LK1 +   to access the Memory Block.
- 3 Press the corresponding CO/PBX line key to change the data option.
- 4 Press  to write the data.
- 5 Press  to go back on-line.

## Related Programming

M.B. Number	Memory Block Name
1-1-72	First Delay Announcement Repeat Selection
1-8-13	VRS Message Function Assignment
3-43	ACD/UCD Delay Announcement Assignment



This Memory Block does not display unless the MIFA-U( ) ETU is installed.



# First Delay Announcement Repeat Selection

## General Description

Use this Memory Block to specify the number of times a First Delay Announcement is repeated.

## Display

Data No.	Title	Setting Data
7 2	: M S G 1 S E N D =	1
T I M E D I S P L A Y		

System Mode  
**1**

Submode  
**1**

Data No.  
**72**





PC Programming  
 + AR

## Settings

LK 1	LK 2	LK 3	LK 4
1 Time	2 Times	3 Times	4 Times
LK 5	LK 6	LK 7	LK 8
5 Times	6 Times	7 Times	8 Times

The shaded area indicates the default setting.

## Programming Procedures

1	Go off-line.
2	Press LK1 + LK1 +   to access the Memory Block.
3	Press the corresponding CO/PBX line key to change the data option.
4	Press  to write the data.
5	Press  to go back on-line.

## Related Programming

M.B. Number	Memory Block Name
1-1-71	First Delay Announcement Start Time Selection
1-8-12	VRS Message Recording Time Selection
1-8-13	VRS Message Function Assignment
3-43	ACD/UCD Delay Announcement Assignment



This Memory Block does not display unless the MIFA-U( ) ETU is installed.

# First to Second Delay Announcement Interval Time Selection

System Mode  
**1**

Submode  
**1**

Data No.  
**73**

PC Programming  
 + AR

## General Description

Use this Memory Block to specify the interval time between the end of the First Delay Announcement sending time and the start time of the Second Delay Announcement.

## Display





Data No.	Title	Setting Data
73	MSG INTVL	= 20
TIME DISPLAY		

## Settings

LK 1	LK 2	LK 3	LK 4
0 sec.	10 sec.	20 sec.	30 sec.
LK 5	LK 6	LK 7	LK 8
40 sec.	50 sec.	60 sec.	No Limit

The shaded area indicates the default setting.

## Programming Procedures

- 1 Go off-line.
- 2 Press LK1 + LK1 +   to access the Memory Block.
- 3 Press the corresponding CO/PBX line key to change the data option.
- 4 Press  to write the data.
- 5 Press  to go back on-line.

## Related Programming

M.B. Number	Memory Block Name
1-1-74	Second Delay Announcement Repeat Selection
1-1-75	Second Delay Announcement Repeat Interval Time Selection
1-8-13	VRS Message Recording Time Selection
3-43	ACD/UCD Delay Announcement Assignment



1. This Memory Block does not display unless the MIFA-U( ) ETU is installed.
2. This Memory Block does not display unless the MIFA-U( ) ETU is installed.

# Second Delay Announcement Repeat Selection

## General Description

Use this Memory Block to specify the number of times a Second Delay Announcement is repeated.

## Display

Data No.	Title	Setting Data
7 4	: M S G 2 S E N D =	1
	T I M E D I S P L A Y	

System Mode  
**1**

Submode  
**1**

Data No.  
**74**

PC Programming



## Settings

LK 1	LK 2	LK 3	LK 4
1 Time	2 Times	3 Times	4 Times
LK 5	LK 6	LK 7	LK 8
5 Times	6 Times	7 Times	8 Times

The shaded area indicates the default setting.

## Programming Procedures

1	Go off-line.
2	Press LK1 + LK1 +   to access the Memory Block.
3	Press the corresponding CO/PBX line key to change the data option.
4	Press  to write the data.
5	Press  to go back on-line.

## Related Programming

M.B. Number	Memory Block Name
1-1-73	First to Second Delay Announcement Interval Time Selection
1-1-75	Second Delay Announcement Repeat Interval Time Selection
1-8-12	VRS Message Recording Time Selection
1-8-13	VRS Message Function Assignment
3-43	ACD/UCD Delay Announcement Assignment

**N**

1. This Memory Block does not display unless the MIFA-U( ) ETU is installed.
2. This Memory Block does not display unless the MIFA-U( ) ETU is installed.
3. When Memory Block 2-08 is used, this is the number of times the message is played back-to-back. After this is done, the system looks at 1-1-75 to repeat the procedure.

# Second Delay Announcement Repeat Interval Time Selection

## General Description

Use this Memory Block to specify the interval time to repeat Second Delay Announcement to the calling party.

## Display

Data No.	Title	Setting Data
7 5	M S G 2 R P E T	= 2 0 s
T I M E D I S P L A Y		

System Mode  
**1**

Submode  
**1**

Data No.  
**75**





PC Programming  
 + AR

## Settings

LK 1	LK 2	LK 3	LK 4
0 sec.	10 sec.	20 sec.	30 sec.
LK 5	LK 6	LK 7	LK 8
40 sec.	50 sec.	60 sec.	No Limit

The shaded area indicates the default setting.

## Programming Procedures

- 1 Go off-line.
- 2 Press LK1 + LK1 +   to access the Memory Block.
- 3 Press the corresponding CO/PBX line key to change the data option.
- 4 Press  to write the data.
- 5 Press  to go back on-line.

## Related Programming

M.B. Number	Memory Block Name
1-1-73	First to Second Delay Announcement Interval Time Selection
1-1-74	Second Delay Announcement Repeat Selection
3-43	ACD/UCD Delay Announcement Assignment



This Memory Block does not display unless the MIFA-U( ) ETU is installed.

# Barge-In Alert Tone Assignment

## General Description

Use this Memory Block to assign the delayed ringing timer for incoming outside line calls.

Applicable to IPK R2000 and above.

## Display

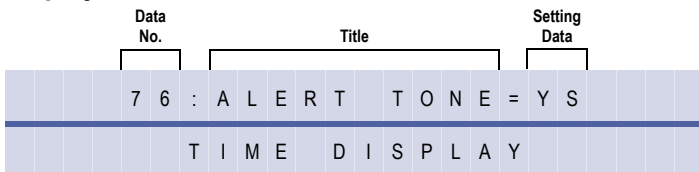

## Settings

LK 1	LK 2	LK 3	LK 4	LK 5	LK 6	LK 7	LK 8
YS	NO						

The shaded area indicates the default setting.

## Programming Procedures

1	Go off-line.	
2	Press LK1 + LK1 +   to access the Memory Block.	
3	Press the corresponding CO/PBX line key to change the data option.	<b>Default Values</b> 15 Seconds
4	Press  to write the data and display the next Memory Block.	
5	Program the next Memory Block or press  to go back on-line.	

## Related Programming

M.B. Number	Memory Block Name
1-8-08	Class of Service (Station) Feature Selection 2
4-17	Station to Class of Service Feature Assignment
4-90	SLT Data Line Security Assignment

# N

- Monitoring telephone conversations may be illegal under certain circumstances and laws. Consult a legal advisor before implementing the monitor of conversations. Some federal and state laws require a monitoring party to use an alert tone to indicate monitoring and/or obtain consent from all parties to the conversation. Some laws provide strict penalties for illegal monitoring of telephone conversations.
- When YS is assigned, both internal and external parties receive the alert tone.

# Delayed Ringing Timer Assignment (CO)

System Mode  
**1**

Submode  
**1**

Data No.  
**77**

PC Programming  
 + BCM





## General Description

Use this Memory Block to assign the delayed ringing timer for incoming outside line calls.

## Display

Data No.	Title	Setting Data
77	DRING ( 1 )	= 15 s
T I M E D I S P L A Y		

## Programming Procedures

1	Go off-line.	
2	Press LK1 + LK1 +   to access the Memory Block.	
3	Use dial pad to enter data.	<b>Default Values</b> 15 Seconds
4	Press  to write the data.	
5	Press  to go back on-line.	

## Related Programming

M.B. Number	Memory Block Name
1-2-26	Delayed Ringing Timer Assignment (ICM)

# Caller ID Display Assignment for System Mode

## General Description

Use this Memory Block to assign up to 15 Multiline Terminals to display Caller ID Indication for normal incoming CO/PBX calls or CO/PBX calls ringing a Call Arrival (CAR) key.

This memory block is removed with IPK R2000 and above.

## Display

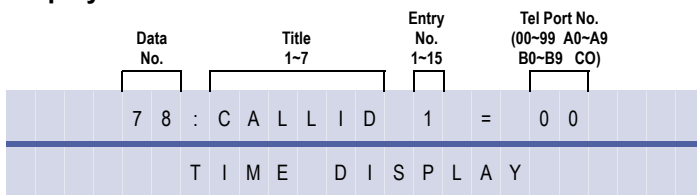









System Mode  
**1**

Submode  
**1**

Data No.  
**78**

PC Programming  
 + AI

## Programming Procedures

<b>1</b>	Go off-line.		
<b>2</b>	Press LK1 + LK1 +   to access the Memory Block.		
<b>3</b>	Use the dial pad to enter Entry No.1 or 2 and Tel Port No. <b>Note:</b> Use the following to enter data: <ul style="list-style-type: none"> <li> to move the cursor left</li> <li> to move the cursor right</li> <li> ~  to enter numeric data</li> </ul>	<b>Default Values</b> Not specified	
<b>4</b>	Press  to write the data and advance to the next Entry No. After data for Entry No. 2 is entered, press  again. A total of 15 entries can be made.		
<b>5</b>	Press  to go back on-line.		

## Related Programming

No related programming is necessary for this Memory Block.

# N

1. To display Caller ID Indication for normal incoming and CAR incoming calls, Caller ID Indication and Ring Assignment must be assigned for the terminal in system programming.
2. Fifteen Multiline Terminals can be assigned system-wide to display Caller ID.
3. A sixteenth terminal can be assigned to display Caller ID using another Memory Block.

# BGM Port Assignment

## General Description

Use this Memory Block to assign the CO/PBX port to use as a Background Music port.

## Display

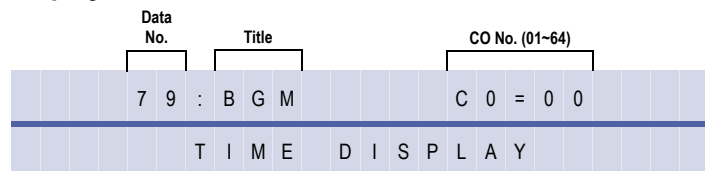

System Mode  
**1**

Submode  
**1**

Data No.  
**79**

PC Programming  
 + BCS

## Programming Procedures

1	Go off-line.	
2	Press LK1 + LK1 +   to access the Memory Block.	
3	Use the dial pad to enter the CO No. <b>Note:</b> Use the following to enter data: <ul style="list-style-type: none"> <li> to move the cursor left</li> <li># key icon"/&gt; to move the cursor right</li> <li> ~  to enter numeric data</li> </ul>	<b>Default Values</b> Not specified
4	Press  to write the data.	
5	Press  to go back on-line.	

## Related Programming

M.B. Number	Memory Block Name
1-8-08	Class of Service (Station) Feature Selection 2
2-06	Line Key Selection for Tenant Mode
4-12	Line Key Selection for Telephone Mode



If separate Music on Hold and Station Background Music are required, use an analogue CO port to support Station Background Music.



# ISDN DTMF Duration/ Interdigit Time Selection

## General Description

Use this Memory Block to specify tone duration and interdigit time of Dual-Tone Multifrequency (DTMF) signals for the ISDN trunk.

## Display

Data No.		Title		Setting Data			
8	0	:	M F	=	1	0 0 / 7 0	
T I M E D I S P L A Y							

## Settings

LK 1		LK 2		LK 3		LK 4	
D.D	I.T.	D.D	I.T.	D.D	I.T.	D.D	I.T.
70ms	60ms	100ms	70ms	400m	100ms	600ms	100ms
LK 5		LK 6		LK 7		LK 8	
D.D	I.T.						
900ms	200ms						

The shaded area indicates the default settings.





System Mode  
**1**

Submode  
**1**

Data No.  
**80**

PC Programming  
 + AN

## Programming Procedures

- 1 Go off-line.
- 2 Press LK1 + LK1 +   to access the Memory Block.
- 3 Press the corresponding CO/PBX line key to change the data option.
- 4 Press  to write the data.
- 5 Press  to go back on-line.

## Related Programming

M.B. Number	Memory Block Name
<b>3-92</b>	Trunk (Installed, DP/DTMF) Selection

# ISDN Dial Interval Timer

## General Description

Use this Memory Block to specify the Dial Interval Timer for ISDN lines.

With IPK R2000 and above, this memory block allows flexible entries and has four classes.

*For R2000 only.*

## Display

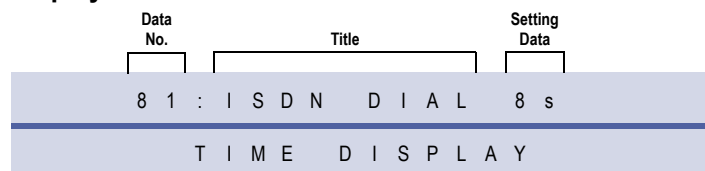

Submode  
**1**

Submode  
**1**

Data No.  
**81**





PC Programming  
 + AN

## Settings

LK 1	LK 2	LK 3	LK 4
2s	4s	8s	16s
LK 5	LK 6	LK 7	LK 8
32s			

The shaded area indicates the default settings.

## Programming Procedures



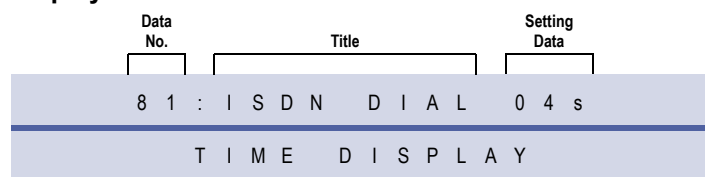

1	Go off-line.
2	Press LK1 + LK1 +   to access the Memory Block.
3	Press the corresponding CO/PBX line key to change the data option.
4	Press  to write the data.
5	Press  to go back on-line.

*For R2000 and above.*



## Display



## Programming Procedures

1	Go off-line.	
2	Press LK1 + LK1 +   to access the Memory Block.	
3	Use the dial pad to enter the time required. <i>Note:</i>  to move cursor left.  to move cursor right. Setting Data (Allow): 01 to 99 sec	Default values: 4 sec

**Programming Procedures** (Continued)

4	Press  to write the data.
5	Press  to go back on-line.

**Related Programming**

M.B. Number	Memory Block Name
3-92	Trunk (Installed, DP/DTMF) Selection
4-71	Time Class Assignment for Telephone Mode (R2000 and above)

# Code Restriction Bypass Table

## General Description





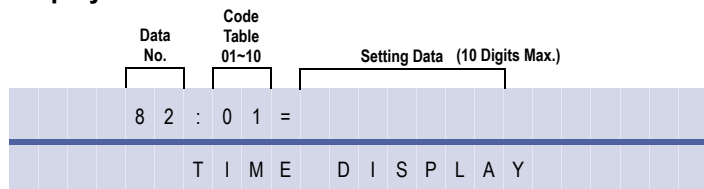

This Memory Block assigns a set of feature codes per system. A Station user can dial these codes as the leading digits of a telephone number. The Xen IPK system ignores these digits and applies code restriction to the remaining digits. The codes are sent to the CO as the leading digits on permitted code restriction calls.

## Display



System Mode  
**1**  
 Submode  
**1**  
 Data No.  
**82**  
 PC Programming  
 + AC

## Programming Procedures

1	Go off-line.	
2	Press LK1 + LK1 +   to access the Memory Block.	
3	Use the dial pad to enter the Table No. <b>Note:</b> Use the following to enter data:  to move the cursor left  to move the cursor right  to enter numeric data	<b>Default Values</b> Not specified
4	Press  to write the data.	
5	Press  to go back on-line.	

## Related Programming

No related programming is necessary for this Memory Block.

**N**

Example: Set Code Table 01 to 1180.  
 When Tel 100 user dials Access Code 0 followed by 1180 then, Telephone Number 12147517 to access a line that is code restricted, the code restriction starts at 12147517. When code restriction is set to allow, the 1214 matches and the call goes through. When Code restriction is deny, the 1214 matches and user receives a reorder tone and ERROR is displayed on telephones that have a display.

# ISDN Stimulus Method Selection

## General Description

Use this Memory Block to specify the country in which the system is being used. This determines the method to be used when activating ISDN supplementary services (stimulus mode).

## Display

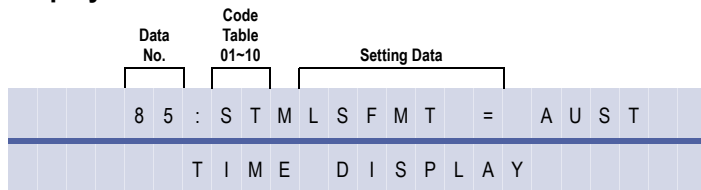

System Mode  
**1**

Submode  
**1**

Data No.  
**85**





PC Programming  
 + AN

## Settings

LK 1	LK 2	LK 3	LK 4
AUST	NZL		
LK 5	LK 6	LK 7	LK 8

The shaded area indicates the default settings.

## Programming Procedures

- 1 Go off-line.
- 2 Press LK1 + LK1 +   to access the Memory Block.
- 3 Press the corresponding CO/PBX line key to change the data option.  
AUST = Australia  
NZL = New Zealand
- 4 Press  to write the data.
- 5 Press  to go back on-line.

## Related Programming

M.B. Number	Memory Block Name
<b>1-8-08</b>	Class of Service (Station) Feature Selection 2
<b>4-17</b>	Station to Class of Service Feature Assignment

# Call Monitoring Alert Assignment

## General Description

Use this Memory Block to specify whether or not Call Monitoring Alert Tone is allowed. When allowed, the Conference LED indicates Call Monitoring. When denied, the Conference LED does not indicate Call Monitoring.

System Software R2000 or higher is required.

## Display

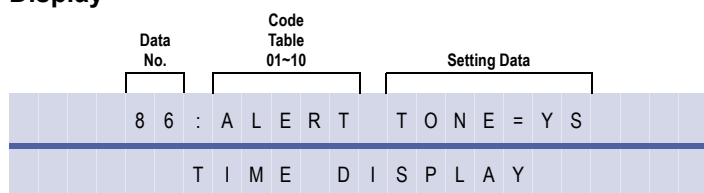

## Settings

LK 1	LK 2	LK 3	LK 4	LK 5	LK 6	LK 7	LK 8
YS	NO						

The shaded area indicates the default settings.

## Programming Procedures

1	Go off-line.
2	Press LK1 + LK1 +   to access the Memory Block.
3	Press the corresponding CO/PBX line key to change the data option.
4	Press  to write the data and display the next Memory Block.
5	Program the next Memory Block or press  to go back on-line.

## Related Programming

M.B. Number	Memory Block Name
1-8-08	Class of Service (Station) Feature Selection 2 (Pg6, LK6 and LK7)



1. When YS is assigned, Call Monitoring Tone and the Conference LED indicate Call Monitoring.
2. When NO is assigned, Call Monitoring Tone and the Conference LED do not indicate Call Monitoring.

# Internal Paging Timeout Selection

## General Description

Use this Memory Block to program the time allowed for paging.

With IPK R2000 and above, this memory block allows flexible entry and four Classes.

*For R2000 only.*

## Display

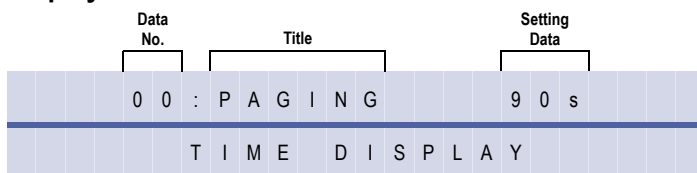

## Settings

LK 1	LK 2	LK 3	LK 4
90 sec.	120 sec.	No Limit	
LK 5	LK 6	LK 7	LK 8

The shaded area indicates the default setting.

## Programming Procedures

1	Go off-line.
2	Press LK1 + LK2 +   to access the Memory Block.
3	Press the corresponding CO/PBX line key to change the data option.
4	Press  to write the data.
5	Press  to go back on-line.

*For R2000 and above.*

## Display

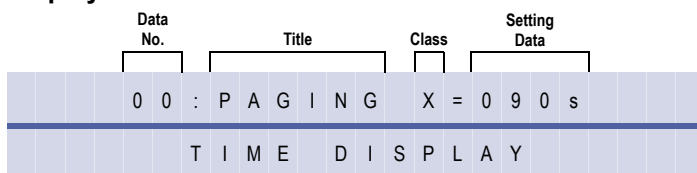

## Programming Procedures

1	Go off-line.
2	Press LK1 + LK2 +   to access the Memory Block.

System Mode  
1  
Submode  
2  
Data No.  
00  
PC Programming  
 +BP





# Intercom Call Voice/Tone Signal Selection

System Mode  
**1**

Submode  
**2**

Data No.  
**01**

PC Programming

 +BI

## General Description

Use this Memory Block to determine whether signal tone or voice is used first for an intercom call.

## Display

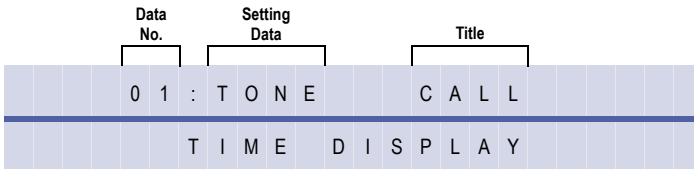





## Settings

LK 1	LK 2	LK 3	LK 4
Tone	Voice		
LK 5	LK 6	LK 7	LK 8

The shaded area indicates the default setting.

## Programming Procedures

<b>1</b>	Go off-line.
<b>2</b>	Press LK1 + LK2 +   to access the Memory Block.
<b>3</b>	Press the corresponding CO/PBX line key to change the data option.
<b>4</b>	Press  to write the data.
<b>5</b>	Press  to go back on-line.

## Related Programming

M.B. Number	Memory Block Name
<b>1-6-03</b>	DSS Call Voice/Tone Signal Selection

# N

- Switch from voice to tone signalling or from tone to voice by dialling a station number, then dialling 1.
- If tone signalling is programmed in this Memory Block, the called party cannot answer handsfree unless the originator of the call dials 1.
- This Memory Block has no effect on incoming Voice Announcement Tie/DID line calls. Refer to Memory Block , 1-1-34 , Tie Line First Ring Pattern Selection.

# Automatic Callback Release Timer Selection

System Mode  
**1**

Submode  
**2**

Data No.  
**02**

PC Programming  

## General Description

Use this Memory Block to determine the time allowed for an automatic callback before the request is automatically cancelled.

With IPK R2000 and above, this memory block allows flexible entry and four Classes.

*For R2000 only.*

## Display





Data No.	Title	Setting Data
0 2	: C A L L B A C K	3 0 m
T I M E D I S P L A Y		

## Settings

LK 1	LK 2	LK 3	LK 4
30 sec.	1 min.	2 min.	3 min.
LK 5	LK 6	LK 7	LK 8
5 min.	10 min.	20 min.	30 min.

The shaded area indicates the default setting.

## Programming Procedures



- 1 Go off-line.
- 2 Press LK1 + LK2 +   to access the Memory Block.
- 3 Press the corresponding CO/PBX line key to change data option.
- 4 Press  to write the data.
- 5 Press  to go back on-line.

*For R2000 and above.*



## Display

Data No.	Title	Class	Setting Data
0 2	: C A L L B A C K X	=	3 0 s
T I M E D I S P L A Y			

## Programming Procedures

- 1 Go off-line.
- 2 Press LK1 + LK2 +   to access the Memory Block.

**Programming Procedures (Continued)**

<p><b>3</b></p>	<p>Use the dial pad to enter the time required.  <i>Note:</i> * to move cursor left.                  # to move cursor right.                  Setting Data (Allow): Class 1 to Class 4: 00 to 99 sec                  00 = No Limit</p>	<p>Default values:                  Class 1 to Class 4 = 30 secs</p>
<p><b>4</b></p>	<p>Press  to write the data.</p>	
<p><b>5</b></p>	<p>Press  to go back on-line.</p>	

**Related Programming**

<p><b>4-71</b></p>	<p>Time Class Assignment for Telephone Mode (R2000 and above)</p>
--------------------	---



# Call Arrival Key Block Assignment

## General Description

Use this Memory Block to specify the number of Call Arrival keys that can be used in the system.

## Display

Data No.	Title	Setting Data
04	CARASSIGN	01
TIME DISPLAY		

System Mode  
**1**

Submode  
**2**

Data No.  
**04**

PC Programming

 +BK

## Settings

### (Page 1)

LK 1	LK 2	LK 3	LK 4
Port 01~04	Port 05~08	Port 09~12	Port 13~16
LK 5	LK 6	LK 7	LK 8
Port 17~20	Port 21~24	Port 25~28	Port 29~32

### (Page 2)

LK 1	LK 2	LK 3	LK 4
Port 33~36	Port 37~40	Port 41~44	Port 45~48
LK 5	LK 6	LK 7	LK 8
Port 49~52	Port 53~56	Port 57~60	Port 61~64

### (Page 3)





LK 1	LK 2	LK 3	LK 4
Port 65~68	Port 69~72	Port 73~76	Port 77~80
LK 5	LK 6	LK 7	LK 8
Port 81~84	Port 85~88	Port 89~92	Port 93~96

No Call Arrival Key Blocks are assigned.

### (Page 4)

LK 1	LK 2	LK 3	LK 4
Port 97~100	Port 101~104	Port 105~108	Port 109~112
LK 5	LK 6	LK 7	LK 8
Port 113~116	Port 117~120		

## Programming Procedures

<b>1</b>	Go off-line.	
<b>2</b>	Press LK1 + LK2 +   to access the Memory Block.	
<b>3</b>	Press the corresponding CO/PBX line key to change the data option. LK is green = block assigned for CAR LK is red = block not available for CAR (hardware is installed)	<b>Default Values</b> No Call Arrival Key Blocks are assigned. Hardware equipped ports are red.
<b>4</b>	Press  to write the data.	
<b>5</b>	Press  to go back on-line.	

**Related Programming**

M.B. Number	Memory Block Name
	Refer to <i>Chapter 2 Guide to Feature Programming</i> .

**N**

1. The Xen IPK system allows a maximum of 120 ports to be shared by station ports (ESI, SLI, VMS) and Call Arrival Keys. If 32 station ports are being used, 88 remain for use as Call Arrival Keys.
2. The Xen IPK system allows a maximum of 32 ports to be shared by station ports (ESI, SLI, VMS) and Call Arrival Keys. If 24 station ports are being used, 8 remain for use as Call Arrival Keys.
3. The Xen IPK system allows a maximum of 32 physical ports to be shared by station ports (ESI, SLI, VMS) and Call Arrival keys, but has 16 extra Call Arrival keys which expand the maximum CAR key assignment to 40. If 32 ports are being used, 16 Call Arrival keys remain to be used.
4. The Xen IPK basic (48) system allows a maximum of 32 ports to be shared by Legacy stations (ESI, SLI, FMS/VMS, and OPX) and Call Arrival Keys. In addition to the shared ports, 40 dedicated CAR ports can also be defined. Dedicated CAR ports are 33~72.

# Specified Station Access Code Assignment

## General Description

Use this Memory Block to assign specific stations to be called using abbreviated dialling. Up to 24 stations can be assigned.

## Display

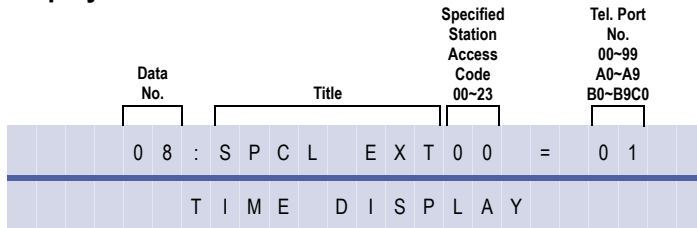

System Mode  
**1**  
Submode  
**2**  
Data No.  
**08**  
PC Programming  
 +BA

## Programming Procedures

1	Go off-line.						
2	Press LK1 + LK2 +   to access the Memory Block.						
3	Enter the options using the dial pad. <b>Note:</b> Use the following to enter data: to move the cursor left to move the cursor right to clear data <b>Setting Data</b> Tel. Port No. 01~120 Specified Station Access Code is 00~23						
<b>Default Values</b>							
<table border="1" style="margin-left: auto;"> <thead> <tr> <th style="text-align: center;">Access Code No.</th> <th style="text-align: center;">Value</th> </tr> </thead> <tbody> <tr> <td style="text-align: center;">00</td> <td style="text-align: center;">01</td> </tr> <tr> <td style="text-align: center;">01-23</td> <td style="text-align: center;">Not Set</td> </tr> </tbody> </table>		Access Code No.	Value	00	01	01-23	Not Set
Access Code No.	Value						
00	01						
01-23	Not Set						
4	Press  to display the Tel. Port No. 01.						
5	After entering the Specified Station No. Access Code, press  to advance to the next Station No.						
6	Press  to write the data.						
7	Press  to go back on-line.						

## Related Programming

M.B. Number	Memory Block Name
1-1-46	Access Code (1-Digit) Assignment
1-1-47	Access Code (2-Digit) Assignment
1-4-14	Automated Attendant Message Access Code (1-Digit) Assignment
1-4-15	Automated Attendant Message Access Code (2-Digit) Assignment



- Specified stations can be accessed from intercom (ICM) dial tone or as an outside caller calling into the Xen IPK system via Auto Attendant.
- The Specified Access Code is assigned in Memory Blocks 1-1-46 , Access Code (1-Digit) Assignment or 1-1-47, Access Code (2-Digit) Assignment.

# Customised Message 1~10 Assignment

System Mode  
**1**

Submode  
**2**

Data No.  
**09~18**

PC Programming  
 +BI







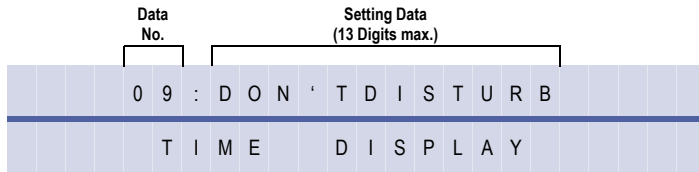



## General Description

Use this Memory Block to program various messages for display at a station LCD. When a user places an intercom (ICM) call from a station equipped with an LCD display to a station in DND mode, the appropriate programmed message displays at the calling station.

## Display



## Programming Procedures

<b>1</b>	Go off-line.																
<b>2</b>	Press LK1 + LK2 +   ~   to access the Memory Block.																
<b>3</b>	<div style="display: flex; justify-content: space-between;"> <div style="width: 60%;"> <p>Enter the options using the dial pad.</p> <p><b>Note:</b> Use the following enter data:</p> <ul style="list-style-type: none"> <li> to move the cursor left</li> <li> to move the cursor right</li> <li> ~  to enter numeric data</li> <li> to clear data</li> </ul> </div> <div style="width: 35%; border: 1px solid black; padding: 5px;"> <p style="text-align: center; margin: 0;"><b>Default Values</b></p> <table border="1" style="width: 100%; border-collapse: collapse; margin: 0;"> <thead> <tr> <th style="text-align: center;">Data No.</th> <th style="text-align: center;">Message</th> </tr> </thead> <tbody> <tr><td style="text-align: center;">09</td><td style="text-align: center;">DON'T DISTURB</td></tr> <tr><td style="text-align: center;">10</td><td style="text-align: center;">MEETING</td></tr> <tr><td style="text-align: center;">11</td><td style="text-align: center;">BUSINESS TRIP</td></tr> <tr><td style="text-align: center;">12</td><td style="text-align: center;">NOT IN</td></tr> <tr><td style="text-align: center;">13</td><td style="text-align: center;">WITH GUEST</td></tr> <tr><td style="text-align: center;">14</td><td style="text-align: center;">OUT OF OFFICE</td></tr> <tr><td style="text-align: center;">15~18</td><td style="text-align: center;">Not Specified</td></tr> </tbody> </table> </div> </div>	Data No.	Message	09	DON'T DISTURB	10	MEETING	11	BUSINESS TRIP	12	NOT IN	13	WITH GUEST	14	OUT OF OFFICE	15~18	Not Specified
Data No.	Message																
09	DON'T DISTURB																
10	MEETING																
11	BUSINESS TRIP																
12	NOT IN																
13	WITH GUEST																
14	OUT OF OFFICE																
15~18	Not Specified																
<b>4</b>	Enter the characters to be displayed. Refer to <i>Section 7, Character Code Tables</i> .																
<b>5</b>	After entering all data for Memory Block , 1-2-09~18 , Customised Message 1~10 Assignment, press  to write the data.																
<b>6</b>	Press  to go back on-line.																

## Related Programming

No related programming is necessary for this Memory Block.



1. Ten messages are available, the first six are assigned at default.
2. Ten messages are available, the first six are assigned at default.
3. System Software allows a message to be entered using the dial pad instead of the ASCII Character Code Tables. Follow the procedure in Appendix B Character Codes, Section 1 Character Assignment on page B-1.



# Intercom Ring Pattern Selection

## General Description

Use this Memory Block to select a ring pattern when intercom calls are made.

## Display

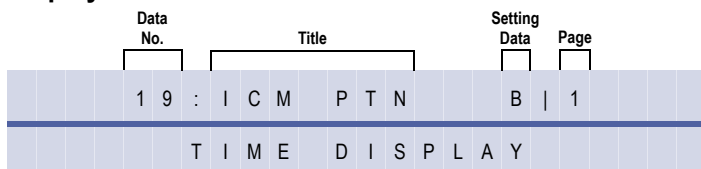

System Mode  
**1**  
Submode  
**2**  
Data No.  
**19**  
PC Programming  
 +BI

## Settings

### (Page 1)

LK 1	LK 2	LK 3	LK 4
Tone Off	Tone On	Pattern A	Pattern B
LK 5	LK 6	LK 7	LK 8
Pattern C	Pattern D	Pattern E	Pattern F

### (Page 2)

LK 1	LK 2	LK 3	LK 4
Pattern G	Pattern H		
LK 5	LK 6	LK 7	LK 8

The shaded area indicates the default setting.

## Programming Procedures

- 1 Go off-line.
- 2 Press LK1 + L2 + to access the Memory Block.
- 3 Press the corresponding CO/PBX line key to change the data option.  
**Note:** Use the following to enter data:  
 to go to the next page  
 to go to the previous page
- 4 Press to write the data.
- 5 Press to go back on-line.

## Related Programming

No related programming is necessary for this Memory Block.

The Ring Patterns are listed in the table below:

s= seconds

Pattern	Line Key	0s	1s	2s	3s	4s	5s	6s
None Off	LK1							
None Off	LK2							
A	LK3							
B	LK4							
C	LK5							
D	LK6							
E	LK7							
F	LK8							
G	LK1 (Pg. 2)							
H	LK2 (Pg. 2)							

# Intercom Ring Tone Selection

## General Description

Use this Memory Block to select a ring tone for intercom calls.

## Display

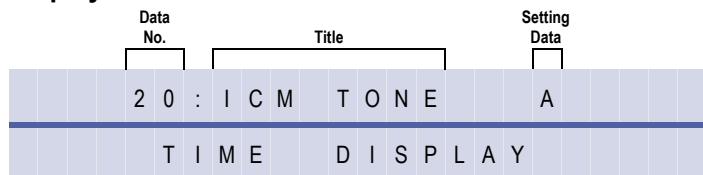

## Settings

LK 1	LK 2	LK 3	LK 4
Tone A	Tone B	Tone C	Tone D
LK 5	LK 6	LK 7	LK 8
Tone E	Tone F	Tone G	Tone H

The shaded area indicates the default setting.

## Programming Procedures

1	Go off-line.
2	Press LK1 + LK2 +   to access the Memory Block.
3	Press the corresponding CO/PBX line key to change the data option.
4	Press  to write the data.
5	Press  to go back on-line.

## Related Programming

No related programming is necessary for this Memory Block.

## N

The available tones are:

- Tone A = (480/600): Modulation (16 Hz)
- Tone B = (480/606): Modulation (8 Hz)
- Tone C = (1024/1285)
- Tone D = (1024)
- Tone E = (500)
- Tone F = (1024/1285): Modulation (16 Hz)
- Tone G = (600/700): Modulation (16 Hz)
- Tone H = (1024) Envelope 2 sec.

System Mode  
**1**

Submode  
**2**

Data No.  
**20**

PC Programming

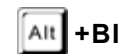

# PHS Telephone Assignment

## General Description

Use this Memory Block to specify the number of PHS Telephones that can be used in the system.

## Display

Data No.	Title	Setting Data
04	PHS ASSIGN	01
TIME DISPLAY		

System Mode  
**1**

Submode  
**2**

Data No.  
**21**

PC Programming  
 +AP

## Settings

### (Page 1)

LK 1	LK 2	LK 3	LK 4
Port 01~04	Port 05~08	Port 09~12	Port 13~16
LK 5	LK 6	LK 7	LK 8
Port 17~20	Port 21~24	Port 25~28	Port 29~32

### (Page 2)

LK 1	LK 2	LK 3	LK 4
Port 33~36	Port 37~40	Port 41~44	Port 45~48
LK 5	LK 6	LK 7	LK 8
Port 49~52	Port 53~56	Port 57~60	Port 61~64

### (Page 3)





LK 1	LK 2	LK 3	LK 4
Port 65~68	Port 69~72	Port 73~76	Port 77~80
LK 5	LK 6	LK 7	LK 8
Port 81~84	Port 85~88	Port 89~92	Port 93~96

No PHS Telephones are assigned.

### (Page 4)

LK 1	LK 2	LK 3	LK 4
Port 97~100	Port 101~104	Port 105~108	Port 109~112
LK 5	LK 6	LK 7	LK 8
Port 113~116	Port 117~120		

## Programming Procedures

1	Go off-line.	
2	Press LK1 + LK2 +   to access the Memory Block.	
3	Press the corresponding CO/PBX line key to change the data option. LK is green = block assigned for PHS Telephones LK is red = block not available for PHS (hardware is installed)	<b>Default Values</b> No PHS Telephones are assigned. Hardware equipped ports are red.
4	Press  to write the data.	
5	Press  to go back on-line.	

**Related Programming**

M.B. Number	Memory Block Name
	Refer to <i>Chapter 2, Guide to Feature Programming</i>

**N**

1. The Xen IPK basic system can support a maximum of 24 PS II stations.
2. The Xen IPK expanded system can support a maximum of 40 PS II stations.
3. The Xen IPK basic system can have 32 ports to be shared by station ports (ESI, SLI, FMS/VMS, CTI, CNF, and OPX), Call Arrival Keys, and PS stations. If 24 station ports are being used, eight remain for use as PS stations.
4. The Xen IPK expanded system allows a maximum of 120 ports to be shared by station ports (ESI, SLI, FMS/VMS, CTI, CNF, and OPX), Call Arrival Keys, PS stations, and IP phones (Memory Block 1-2-32.)
5. The total number of PS station ports are shared with the total number of hardware and software station ports.

# Call Forward No Answer Timer Selection

System Mode  
**1**

Submode  
**2**

Data No.  
**22**

PC Programming  

## General Description

Use this Memory Block to specify the time before incoming intercom calls or incoming CO/PBX lines are forwarded to another station number if the called party does not answer.

With IPK R2000 and above, this memory block allows flexible entry and four Classes.

*For R2000 only.*

## Display

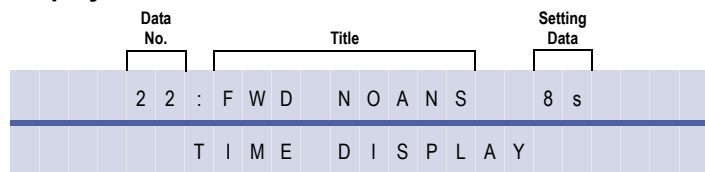





## Settings

LK 1	LK 2	LK 3	LK 4
4 sec.	8 sec.	12 sec.	18 sec.
LK 5	LK 6	LK 7	LK 8
24 sec.	30 sec.	60 sec.	

The shaded area indicates the default setting.

## Programming Procedures



- 1 Go off-line.
- 2 Press LK1 + LK2 +   to access the Memory Block.
- 3 Press the corresponding CO/PBX line key to change the data option.
- 4 Press  to write the data.
- 5 Press  to go back on-line.

*For R2000 and above.*

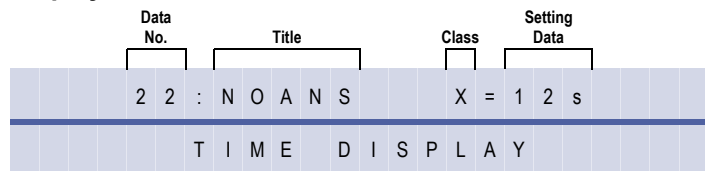

## Display



## Programming Procedures

- 1 Go off-line.
- 2 Press LK1 + LK2 +   to access the Memory Block.

**Programming Procedures (Continued)**

<b>3</b>	Use the dial pad to enter the time required. <i>Note:</i> * to move cursor left. # to move cursor right. Setting Data (Allow): Class 1 to Class 4: 01 to 99 sec	Default values: Class 1 to Class 4 = 12 secs
<b>4</b>	Press  to write the data.	
<b>5</b>	Press  to go back on-line.	

**Related Programming**

M.B. Number	Memory Block Name
<b>1-1-46</b>	Access Code (1-Digit) Assignment
<b>1-1-47</b>	Access Code (2-Digit) Assignment
<b>1-2-01</b>	Intercom Call Voice/Tone Signal Selection
<b>1-8-08</b>	Class of Service (Station) Feature Selection 2
<b>4-17</b>	Station to Class of Service Feature Assignment
<b>4-42</b>	Call Forward-Busy Immediately/Delay Selection
<b>4-71</b>	Time Class Assignment for Telephone Mode (R2000 and above)

**N**

1. For ACD Call Forward No Answer time refer to Memory Block , 1-8-40.
2. This will effect ICM, DIT, DID, TLI calls. CO Ringing Assigned Calls do not follow this Memory Block setting.

# System Call Park Recall Time Selection

System Mode

1

Submode

2

Data No.

23

PC Programming



## General Description

Use this Memory Block to specify the time before a CO/PBX call recalls back to a station from Call Park.

With IPK R2000 and above, this memory block allows flexible entry and four Classes.

*For R2000 only.*

## Display

Data No.	Title	Setting Data
23	PARK RECL	1.0
TIME DISPLAY		

## Settings

LK 1	LK 2	LK 3	LK 4
.5 min.	1 min.	1.5 min.	2 min.
LK 5	LK 6	LK 7	LK 8
3 min.	5 min.	8 min.	10 min.

The shaded area indicates the default setting.

## Programming Procedures

1	Go off-line.
2	Press LK1 + LK2 +   to access the Memory Block.
3	Press the corresponding CO/PBX line key to change the data option.
4	Press  to write the data.
5	Press  to go back on-line.

*For R2000 and above.*

## Display



Data No.	Title	Class	Setting Data
23	PARK RCL	X	= 60 s
TIME DISPLAY			

## Programming Procedures

1	Go off-line.
2	Press LK1 + LK2 +   to access the Memory Block.



**Programming Procedures (Continued)**

<b>3</b>	Use the dial pad to enter the time required. <i>Note:</i> * to move cursor left. # to move cursor right. Setting Data (Allow): Class 1 to Class 4: 001 to 99 sec	Default values: Class 1 to Class 4 = 60 secs
<b>4</b>	Press  to write the data.	
<b>5</b>	Press  to go back on-line.	

**Related Programming**

M.B. Number	Memory Block Name
<b>4-71</b>	Time Class Assignment for Telephone Mode (R2000 and above)

# Intercom Feature Access Code Assignment

*System Mode*  
**1**  
*Submode*  
**2**  
*Data No.*  
**24**  
*PC Programming*  











## General Description

Use this Memory Block to assign the Access Code for Voice/Tone change or Step Call.

## Display

Data No.	Title	Setting Data
24	FEA AC (0)	= 004
TIME DISPLAY		

## Programming Procedures

<b>1</b>	Go off-line.																												
<b>2</b>	Press LK1 + LK2 +   to access the Memory Block.																												
<b>3</b>	<div style="display: flex; justify-content: space-between;"> <div style="width: 60%;"> <p>Use the dial pad to enter the Setting Data.</p> <p><b>Note:</b> Use the following to enter data:</p> <ul style="list-style-type: none"> <li> to move the cursor left</li> <li> to move the cursor right</li> <li> ~  to enter numeric data</li> </ul> <p><b>Setting Data</b></p> <table border="1" style="width: 100%; border-collapse: collapse; text-align: center;"> <thead> <tr> <th>Setting Code</th> <th>Feature</th> </tr> </thead> <tbody> <tr><td>000</td><td>Not Used</td></tr> <tr><td>001</td><td>Voice/Tone Switching</td></tr> <tr><td>002</td><td>Step Call</td></tr> <tr><td>003</td><td>Tone Override</td></tr> <tr><td>004</td><td>Automatic Callback</td></tr> <tr><td>005</td><td>Callback Request</td></tr> <tr><td>006</td><td>Voice Over Originate</td></tr> <tr><td>007</td><td>Quick Transfer to Voice Mail</td></tr> </tbody> </table> </div> <div style="width: 35%;"> <p><b>Default Values</b></p> <table border="1" style="width: 100%; border-collapse: collapse; text-align: center;"> <thead> <tr> <th>Dial Numbers</th> </tr> </thead> <tbody> <tr><td>0 = 004</td></tr> <tr><td>1 = 001</td></tr> <tr><td>2 = 002</td></tr> <tr><td>3~5 = 000</td></tr> <tr><td>6 = 006</td></tr> <tr><td>7 = 007</td></tr> <tr><td>8,9 = 000</td></tr> <tr><td>* = 003</td></tr> <tr><td># = 005</td></tr> </tbody> </table> </div> </div>	Setting Code	Feature	000	Not Used	001	Voice/Tone Switching	002	Step Call	003	Tone Override	004	Automatic Callback	005	Callback Request	006	Voice Over Originate	007	Quick Transfer to Voice Mail	Dial Numbers	0 = 004	1 = 001	2 = 002	3~5 = 000	6 = 006	7 = 007	8,9 = 000	* = 003	# = 005
Setting Code	Feature																												
000	Not Used																												
001	Voice/Tone Switching																												
002	Step Call																												
003	Tone Override																												
004	Automatic Callback																												
005	Callback Request																												
006	Voice Over Originate																												
007	Quick Transfer to Voice Mail																												
Dial Numbers																													
0 = 004																													
1 = 001																													
2 = 002																													
3~5 = 000																													
6 = 006																													
7 = 007																													
8,9 = 000																													
* = 003																													
# = 005																													
<b>4</b>	Press  to write the data and advance to the next Dial No.																												
<b>5</b>	After entering all data, press  to write the data.																												
<b>6</b>	Press  to go back on-line.																												

## Related Programming

M.B. Number	Memory Block Name
<b>1-2-01</b>	Intercom Call Voice/Tone Signal Selection
<b>1-8-08</b>	Class of Service (Station) Feature Selection 2
<b>1-8-26</b>	Voice Mail Quick Transfer Master Hunt Number
<b>4-17</b>	Station to Class of Service Feature Assignment

**N**

1. Features can be assigned to more than one dial number.
2. To enter \* or # under Dial Numbers Selection, press  + \* or #.

# Internal Paging Alert Tone Selection

## General Description

Use this Memory Block to determine whether or not a call alert tone is provided when Internal Paging is used.

## Display

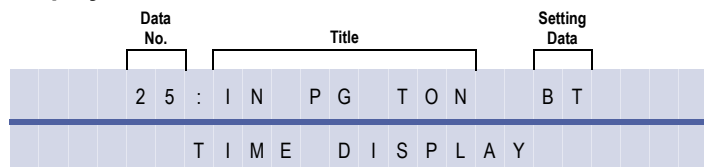

System Mode  
**1**

Submode  
**2**

Data No.  
**25**

PC Programming  
 +BP

## Settings

LK 1	LK 2	LK 3	LK 4
Tone YS	Tone NO		
LK 5	LK 6	LK 7	LK 8

The shaded area indicates the default setting.

## Programming Procedures

- 1 Go off-line.
- 2 Press LK1 + LK2 + to access the Memory Block.
- 3 Press the corresponding CO/PBX line key to change the data option.
- 4 Press to write the data.
- 5 Press to go back on-line.

## Related Programming

No related programming is necessary for this Memory Block.

# Delayed Ringing Timer Assignment (ICM)

## General Description

Use this Memory Block to assign the delayed ringing timer for incoming internal calls.

## Display

Data No.	Title	Setting Data
26	DRING ( 1 )	= 10
T I M E D I S P L A Y		





System Mode  
**1**

Submode  
**2**

Data No.  
**26**

PC Programming  
 + BI

## Programming Procedures

1	Go off-line.	
2	Press LK1 + LK2 +   to access the Memory Block.	
3	Enter data using the dial pad.	<b>Default Values</b> 10 seconds
4	Press  to write data.	
5	Press  to go back on-line.	

## Related Programming

M.B. Number	Memory Block Name
4-37	Extension Line Key Ring Assignment (Day Mode)
4-38	Extension Line Key Ring Assignment (Night Mode)

# PS Out of Area Tone Selection

## General Description

Use this Memory Block to specify whether a call to a PS Handset which is currently out of coverage area will receive Busy Tone (BT) or Ring Back Tone (RBT).

## Display

Data No.	Title	Setting Data
28	PS TONE	= BT
T I M E D I S P L A Y		

System Mode  
**1**

Submode  
**2**

Data No.  
**28**





PC Programming  
 +AP

## Settings

LK 1	LK 2	LK 3	LK 4
BT	RBT		
LK 5	LK 6	LK 7	LK 8

The shaded area indicates the default setting.

## Programming Procedures

- 1 Go off-line.
- 2 Press LK1 + LK2 +   to access the Memory Block.
- 3 Press the corresponding CO/PBX line key to change the data option.
- 4 Press  to write data.
- 5 Press  to go back on-line.

## Related Programming

No related programming is necessary for this Memory Block.



Ring Back Tone is the ringing tone heard by the caller.

Refer to the Features and Specifications Manual, feature M6 - Multi-zone Digital Cordless for instructions with VM when PHS phone is set to CFBNA and turn off or out of area.

# PS Out of Area Timer Selection (BSU only)

## General Description







Use this Memory Block to specify the retry time when a Dterm PS is Out of Area.

## Display

Data No.	Title	Setting Data Data 00-99
30	OUT TIMER	= 08 s
TIME DISPLAY		

System Mode  
**1**  
 Submode  
**2**  
 Data No.  
**30**  
 PC Programming  
 +AP

## Programming Procedures

1	Go off-line.	
2	Press LK1 + LK2 +   to access the Memory Block.	
3	Use the Dial Pad to enter the setting data <b>Note:</b> Use the following to enter data:  to move the cursor left  to move the cursor right	<b>Default Values</b> 12 sec <b>Setting Data</b> 00~99
4	Press  to write data.	
5	Press  to go back on-line.	

## Related Programming

No related programming is necessary for this Memory Block.

# N

- Ring Back Tone is the ringing tone heard by the caller.
- Refer to the Features and Specifications manual, feature M6 - Multi-zone Digital Cordless for instructions with VM when PHS phone is set to CFBNA and turn off or out of area.
- When the PS Out of Area time is shorter than the Call Forward-No Answer time, the caller receives an Out of Area indication.
- This Memory Block is used to define the Time a system searches for a PS II before displaying Out of Area or providing a busy tone to the Caller.
- When using Call Forward - Busy/No Answer feature, verify that the time is compatible with this Memory Block.

### MB1-2-30 = 00 seconds

### Follows 1-2-22 timer (BNA)

MB1-2-28 PHS off	Setting BT	Returned to call RBT	
	Setting RBT	Returned to call RBT	
MB1-2-28 PHS Busy	Setting BT	Returned to call RBT	
	Setting RBT	Returned to call RBT	

### MB1-2-30 = XX seconds

### Follows 1-2-30 timer

MB1-2-28 PHS off	Setting BT	Returned to call BT	
	Setting RBT	Returned to call BT	
MB1-2-28 PHS Busy	Setting BT	Returned to call RBT	
	Setting RBT	Returned to call RBT	

# Call Pickup Group - Direct

## General Description

Text to be inserted

## Display

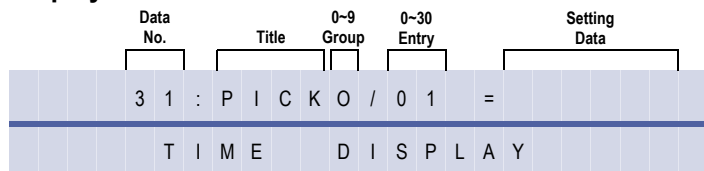

System Mode  
**1**

Submode  
**2**

Data No.  
**31**

PC Programming  
 +BTC

## Programming Procedures

1	Go off-line.
2	Press LK1 + LK2 +   to access the Memory Block.
3	Use the dial pad to enter the Call Pickup Group followed by extension number. <b>Note:</b> Use the following to enter data: to move the cursor left to move the cursor right
	<b>Setting Data</b> Groups = 0~9 Groups Extensions per Group = 01~30
4	Press  to write data.
5	Press  to go back on-line.

## Related Programming

M.B. Number	Memory Block Name
1-1-46	Access Code (1-Digit) Assignment
1-1-47	Access Code (2-Digit) Assignment
1-1-48	Access Code (3-Digit) Assignment



# Bounce Protect Time Selection

## General Description

Use this Memory Block to specify the time before a valid hookflash is detected from a Single Line Telephone or Voice Mail system.

## Display

Data No.	Title	Setting Data	Page No.
01	B N C E	300ms	1
T I M E D I S P L A Y			

System Mode  
**1**

Submode  
**3**

Data No.  
**01**

PC Programming

 + BTI

## Settings

(Page 1)





LK 1	LK 2	LK 3	LK 4
0 ms.	100 ms.	200 ms.	300 ms.
LK 5	LK 6	LK 7	LK 8
400 ms.	500 ms.	600 ms.	700 ms.

(Page 2)

LK 1	LK 2	LK 3	LK 4
800 ms.	900 ms.	1000 ms.	1100 ms.
LK 5	LK 6	LK 7	LK 8
1200 ms.	1300 ms.	1400 ms.	1500 ms.

The shaded area indicates the default setting.

## Programming Procedures

<b>1</b>	Go off-line.
<b>2</b>	Press LK1 + LK3 +   to access the Memory Block.
<b>3</b>	Press the corresponding CO/PBX line key to change the data option.
<b>4</b>	Press  to write the data.
<b>5</b>	Press  to go back on-line.

## Related Programming

M.B. Number	Memory Block Name
<b>1-3-05</b>	Hookflash Start Time Selection

# N

Bounce Protect Time should be equal to Hookflash Start Time in Memory Block 1-3-05 Hookflash Start Time Selection.

# SLT Hookflash Signal Selection

*System Mode*  
**1**

*Submode*  
**3**

*Data No.*  
**02**

*PC Programming*  
 + BTI

## General Description

Use this Memory Block to specify whether a line is held internally, or if behind a PBX, a hookflash (HF) signal is sent to the line when a Single Line Telephone user performs a hookflash.

## Display





Data No.	Title	Setting Data
02	: S I G N A L	H O L D
	T I M E	D I S P L A Y

## Settings

LK 1	LK 2	LK 3	LK 4
Hold	Flash		
LK 5	LK 6	LK 7	LK 8

The shaded area indicates the default setting.

## Programming Procedures

1	Go off-line.
2	Press LK1 + LK3 +   to access the Memory Block.
3	Press the corresponding CO/PBX line key to change the data option.
4	Press  to write the data.
5	Press  to go back on-line.

## Related Programming

M.B. Number	Memory Block Name
1-1-02	Hookflash Time Selection
4-24	SLT Hookflash Assignment



1. If Hold is specified, the CO/PBX line is put on Exclusive Hold.
2. If Hold is selected, the PBX/CTX line can receive the hookflash signal via Access Code **6#** (default).
3. If Flash is specified, press the hookswitch to send the hookflash signal to the PBX/CTX line.

# First Digit PBR Release Timer Selection

## General Description

Use this Memory Block to specify how long a Push Button Receiver (PBR) receiver circuit is connected when a dual-tone multifrequency (DTMF) Single Line Telephone user goes off-hook. After the timer expires the PBR is disconnected. If the Single Line Telephone user dials a digit before the timer expires, a PBR interdigit timer starts.

With IPK R2000 and above, this memory block allows flexible entry and four classes.

*For R2000 only.*

## Display

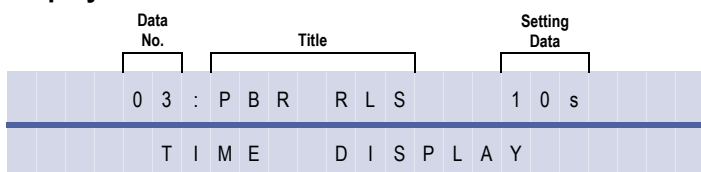

## Settings

LK 1	LK 2	LK 3	LK 4
10 sec.	20 sec.	30 sec.	40 sec.
LK 5	LK 6	LK 7	LK 8
50 sec.	60 sec.		

The shaded area indicates the default setting.

## Programming Procedures

- 1 Go off-line.
- 2 Press LK1 + LK1 + to access the Memory Block.
- 3 Press the corresponding CO/PBX line key to change data option.
- 4 Press to write the data.
- 5 Press to go back on-line.

*For R2000 and above.*

## Display

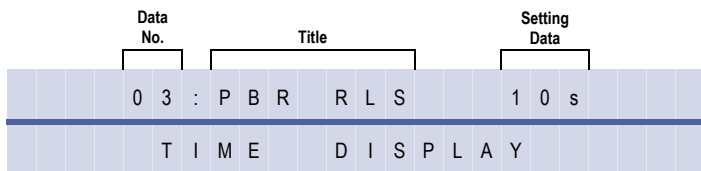

## Programming Procedures

- 1 Go off-line.
- 2 Press LK1 + LK1 + to access the Memory Block.

System Mode  
1  
Submode  
3  
Data No.  
03  
PC Programming  
 + BTI

**Programming Procedures** (Continued)

<b>3</b>	Use the dial pad to enter the time required. <i>Note:</i> * to move cursor left. # to move cursor right. Setting Data (Allow): Class 1 to Class 4: 01 to 99 sec	Default values: 10 secs
<b>4</b>	Press  to write the data.	
<b>5</b>	Press  to go back on-line.	

**Related Programming**

M.B. Number	Memory Block Name
<b>1-8-10</b>	PBR Interdigit Release Timer Selection
<b>4-93</b>	DTMF/DP SLT Type Selection
<b>4-71</b>	Time Class Assignment for Telephone Mode (R2000 and above)

# Dial 1 (DP) Hookflash Selection

## General Description

Use this Memory Block to specify whether or not pressing 1 during an intercom call or a CO/PBX call on a dial pulse (DP) Single Line Telephone provides a hookflash signal.

## Display

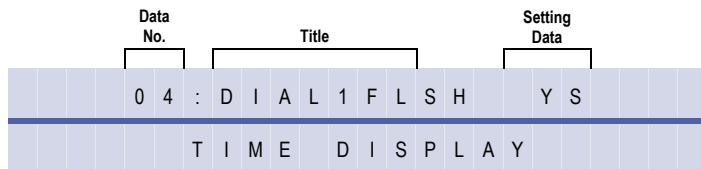

## Settings

LK 1	LK 2	LK 3	LK 4
Yes	No		
LK 5	LK 6	LK 7	LK 8

The shaded area indicates the default setting.

## Programming Procedures

- 1 Go off-line.
- 2 Press LK1 + LK3 + to access the Memory Block.
- 3 Press the corresponding CO/PBX line key to change the data option.
- 4 Press to write the data.
- 5 Press to go back on-line.

## Related Programming

M.B. Number	Memory Block Name
4-67	SLT Data Line Security Assignment
4-93	DTMF/DP SLT Type Selection

System Mode  
**1**

Submode  
**3**

Data No.  
**04**

PC Programming  
 + BTI

# Hookflash Start Time Selection

System Mode  
**1**

Submode  
**3**

Data No.  
**05**

PC Programming  
 + BTI

## General Description

Use this Memory Block to specify the minimum hookflash duration from Single Line Telephone.

## Display

Data No.	Title	Setting Data	Page No.
05	FLASH ST	40	1
TIME DISPLAY			

## Settings

### (Page 1)





LK 1	LK 2	LK 3	LK 4
40 ms.	90 ms.	140 ms.	190 ms.
LK 5	LK 6	LK 7	LK 8
240 ms.	290 ms.	340 ms.	390 ms.

### (Page 2)

LK 1	LK 2	LK 3	LK 4
440 ms.	490 ms.	540 ms.	590 ms.
LK 5	LK 6	LK 7	LK 8
640 ms.	690 ms.	740 ms.	790 ms.

The shaded area indicates the default setting.

## Programming Procedures

<b>1</b>	Go off-line.
<b>2</b>	Press LK1 + LK3 +   to access the Memory Block.
<b>3</b>	Press the corresponding CO/PBX line key to change the data option.
<b>4</b>	Press  to write the data.
<b>5</b>	Press  to go back on-line.

## Related Programming

M.B. Number	Memory Block Name
<b>1-3-01</b>	Bounce Protect Time Selection
<b>1-3-06</b>	Hookflash End Time Selection



1. Press hookswitch during CO/PBX call to place the line on hold or send hookflash to CO/PBX.
2. Bounce Protect Time [Memory Block 1-3-01 Bounce Protect Time Selection] and Hookflash Start Time must be equal.

# Hookflash End Time Selection

## General Description

Use this Memory Block to specify the maximum hookflash duration from a Single Line Telephone to receive a second dial tone.

## Display

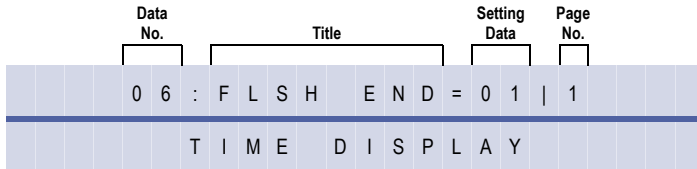

System Mode  
**1**  
Submode  
**3**  
Data No.  
**06**  
PC Programming  
 + BTI

## Settings

### (Page 1)

LK 1	LK 2	LK 3	LK 4
00 (HST + 0 ms.)	01 (HST + 100 ms.)	02 (HST + 200 ms.)	03 (HST + 300 ms.)
LK 5	LK 6	LK 7	LK 8
04 (HST + 400 ms.)	05 (HST + 500 ms.)	06 (HST + 600 ms.)	07 (HST + 700 ms.)

### (Page 2)

LK 1	LK 2	LK 3	LK 4
08 (HST + 800 ms.)	09 (HST + 900 ms.)	10 (HST + 1000 ms.)	11 (HST + 1100 ms.)
LK 5	LK 6	LK 7	LK 8
12 (HST + 1200 ms.)	13 (HST + 1300 ms.)	14 (HST + 1400 ms.)	15 (HST + 1500 ms.)

The shaded area indicates the default setting.  
 HST = Hookflash Start Time

## Programming Procedures

- 1 Go off-line.
- 2 Press LK1 + LK3 + to access the Memory Block.
- 3 Press the corresponding CO/PBX line key to change the data option.
- 4 Press to write the data.
- 5 Press to go back on-line.

## Related Programming

M.B. Number	Memory Block Name
1-3-05	Hookflash Start Time Selection

# Voice Mail Digit Add Assignment

System Mode  
**1**

Submode  
**3**

Data No.  
**07**

PC Programming  
 + AV







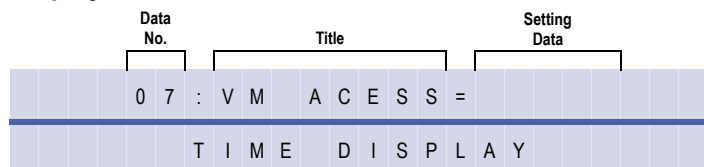



## General Description

Use this Memory Block to assign up to four digits in front of the station number sent to the voice mail when a call is forwarded.

## Display



## Programming Procedures

1	Go off-line.	
2	Press LK1 + LK3 +   to access the Memory Block.	
3	Use the dial pad to enter data. <b>Note:</b> Use the following to enter data:  ~  to enter numeric data  +  to enter * input  +  to enter # input Setting Data: 0~9, *, # (Up to 4 digits)	<b>Default Values</b> All Blank
4	Press  to write the data.	
5	Press  to go back on-line.	

## Related Programming

M.B. Number	Memory Block Name
4-35	Voice Mail/SLT Selection



# Voice Mail DTMF Delay Timer Selection

## General Description

Use this Memory Block to specify the delay time before dual-tone multifrequency (DTMF) tones are sent from Voice Mail Interface (VMI) ports.

## Display

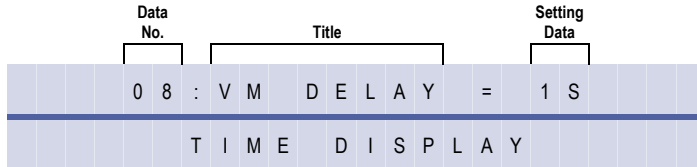

## Settings

LK 1	LK 2	LK 3	LK 4
0 sec.	1 sec.	2 sec.	3 sec.
LK 5	LK 6	LK 7	LK 8
4 sec.	5 sec.	6 sec.	8 sec.

The shaded area indicates the default setting.

## Programming Procedures

1	Go off-line.
2	Press LK1 + LK3 +   to access the Memory Block.
3	Press the corresponding CO/PBX line key to change the data option.
4	Press  to write the data.
5	Press  to go back on-line.

## Related Programming

M.B. Number	Memory Block Name
4-35	Voice Mail/SLT Selection

System Mode  
**1**

Submode  
**3**

Data No.  
**08**

PC Programming  
 + AV

N

This Memory Block applies to both digital voice mail and analogue voice mail ports.

# Voice Mail Disconnect Time Selection

## General Description

Use this Memory Block to specify the length of a disconnect signal sent to the voice mail equipment.

## Display

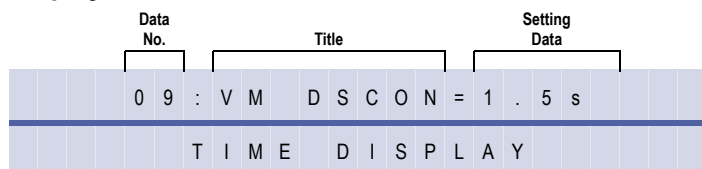

System Mode  
**1**

Submode  
**3**

Data No.  
**09**

PC Programming  
 + AV

## Settings

LK 1	LK 2	LK 3	LK 4
0.5 sec.	1.0 sec.	1.5 sec.	2.0 sec.
LK 5	LK 6	LK 7	LK 8
3.0 sec.	3.5 sec.		

The shaded area indicates the default setting.

## Programming Procedures

- 1 Go off-line.
- 2 Press LK1 + LK3 + to access the Memory Block.
- 3 Press the corresponding CO/PBX line key to change the data option.
- 4 Press to write the data.
- 5 Press to go back on-line.

## Related Programming

M.B. Number	Memory Block Name
4-35	Voice Mail/SLT Selection

# Voice Mail DTMF Duration/ Interdigit Time Selection

## General Description

Use this Memory Block to specify dual-tone multifrequency (DTMF) duration and interdigit time for Voice Mail.

## Display

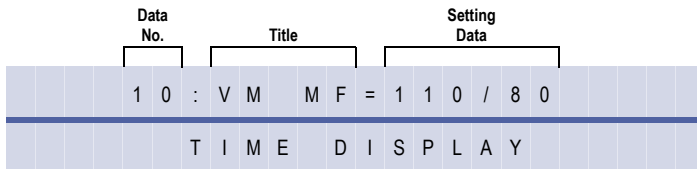

System Mode  
**1**  
Submode  
**3**  
Data No.  
**10**  
PC Programming  
 + AV

## Settings

LK 1	LK 2	LK 3	LK 4
60/70 ms.	110/80 ms.	410/100 ms.	610/100 ms.
LK 5	LK 6	LK 7	LK 8
810/190 ms.			

The shaded area indicates the default setting for a Duration Time/Interdigit Time.

## Programming Procedures

1	Go off-line.	
2	Press LK1 + LK3 +   to access the Memory Block.	
3	Press the corresponding CO/PBX key to change data option.	<b>Default Values</b> Duration Time: 110 ms. Interdigit Time: 80 ms.
4	Press  to write the data.	
5	Press  to go back on-line.	

## Related Programming

M.B. Number	Memory Block Name
4-35	Voice Mail/SLT Selection

# SLT/PHS Talk Start Timer

## General Description

Use this Memory Block to assign the time needed after a hookflash and dialling before three-party (two Cos and one SLT) line conference is allowed from a Single Line Telephone or PHS handset.

## Display

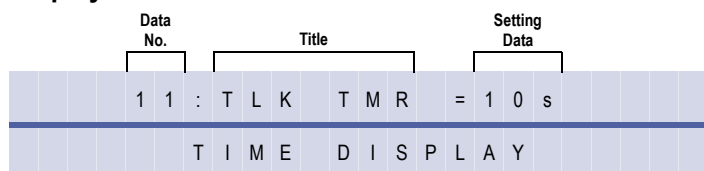

System Mode  
**1**

Submode  
**3**

Data No.  
**11**

PC Programming  
 + BTI

## Programming Procedures

1	Go off-line.	
2	Press LK1 + LK3 +   to access the Memory Block.	
3	Use the dial pad to enter data. NOTE: Use the following to enter data: to enter numeric data to move the cursor left to move the cursor right Setting Data: 01~99 sec	<b>Default Values</b> 10 sec
4	Press  to write the data and display the next Memory Block	
5	Program the next Memory Block or press  to go back on-line.	

## Related Programming

M.B. Number	Memory Block Name
1-8-08	Class of Service (Station) Feature Selection 2 (Page 3, LK5)
3-04	Trunk-to-Trunk Transfer Yes/No Selection
4-17	Station to Class of Service Feature Assignment

# Tandem Transfer Automatic Disconnect Timer Selection

## General Description

Use this Memory Block to specify maximum time before the system automatically disconnects a Trunk-to-Trunk connection.

With IPK R2000 and above, this memory block allows flexible entry.

## Display

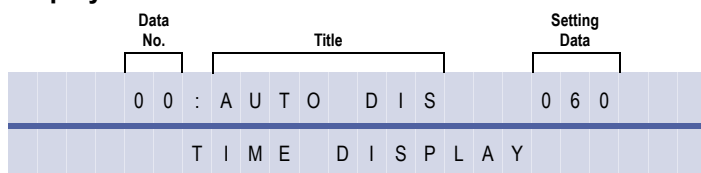

System Mode  
1

Submode  
4

Data No.  
00

PC Programming  
 + AT

## Programming Procedures

1	Go off-line.	
2	Press LK1 + LK4 +   to access the Memory Block.	
3	Press the corresponding CO/PBX line key to change the data option or enter the time required in minutes	<b>Default Values</b> 060 min
4	Press  to write the data.	
5	Press  to go back on-line.	

## Related Programming

M.B. Number	Memory Block Name
	Time Class Assignment for Telephone Mode (R2000 and above)



This block is used for Direct Inward System Access (DISA), Trunk-to-Trunk Transfer, Call Forward - Off Premise, and Tie line tandem features.

# Automated Attendant First Digit PBR Release Timer Selection

*System Mode*  
**1**  
*Submode*  
**4**  
*Data No.*  
**01**  
*PC Programming*  
 + AU

## General Description

Use this Memory Block to specify the time a Push Button Receiver (PBR) circuit remains connected after the Automated Attendant message is played when a calling party calls in through an Automated Attendant trunk.

With IPK R2000 and above, this memory block allows flexible entry and four Classes.

*For R2000 only.*

## Display





Data No.	Title	Setting Data
01	A A P B R T I M E	20 s
T I M E D I S P L A Y		

## Settings

LK 1	LK 2	LK 3	LK 4
5 sec.	10 sec.	20 sec.	30 sec.
LK 5	LK 6	LK 7	LK 8
40 sec.	50 sec.	60 sec.	

The shaded area indicates the default setting.

## Programming Procedures



- 1 Go off-line.
- 2 Press LK1 + LK4 +   to access the Memory Block.
- 3 Press the corresponding CO/PBX line key to change the data option.
- 4 Press  to write the data.
- 5 Press  to go back on-line.

*For R2000 and above.*



## Display

Data No.	Title	Setting Data
01	A A P B R R L S	20 s
T I M E D I S P L A Y		

## Programming Procedures

- 1 Go off-line.
- 2 Press LK1 + LK4 +   to access the Memory Block.

**Programming Procedures**

<b>3</b>	Use the dial pad to enter the time required. <i>Note:</i> * to move cursor left. # to move cursor right. Setting Data (Allow): 01 to 99 sec	Default values: 20 secs
<b>4</b>	Press  to write the data.	
<b>5</b>	Press  to go back on-line.	

**Related Programming**

M.B. Number	Memory Block Name
<b>4-71</b>	Time Class Assignment for Telephone Mode (R2000 and above)

**N**

After PBR is connected, dialling must be completed in the specified time. After the first digit is dialled, interdigit timing (default 7 sec.) controls the PBR timer. Dialling the third digit exceeds the 20 sec. default, and the PBR is disconnected.

# Automated Attendant Transfer Delayed Ringing Time Selection

*System Mode*  
**1**  
*Submode*  
**4**  
*Data No.*  
**02**  
*PC Programming*  
 + AU

### General Description

Use this Memory Block to specify the time that a call rings at the destination station before the automated attendant rings a programmed station.

With IPK R2000 and above, this memory block allows flexible entry and four Classes.

### For R2000 only.

#### Display





Data No.	Title	Setting Data
0 2	: A A D L Y R N G	∞
T I M E D I S P L A Y		

#### Settings

LK 1	LK 2	LK 3	LK 4
10 sec.	20 sec.	30 sec.	∞
LK 5	LK 6	LK 7	LK 8

The shaded area indicates the default setting.

#### Programming Procedures



- 1 Go off-line.
- 2 Press LK1 + LK4 +   to access the Memory Block.
- 3 Press the corresponding CO/PBX line key to change data option.
- 4 Press  to write the data.
- 5 Press  to go back on-line.

### For R2000 and above.

#### Display

Data No.	Title	Class	Setting Data
0 2	: A A D L Y R N G X =	0 0	s
T I M E D I S P L A Y			

#### Programming Procedures

- 1 Go off-line.
- 2 Press LK1 + LK4 +   to access the Memory Block.



**Programming Procedures**

<b>3</b>	Use the dial pad to enter the time required. <i>Note:</i> * to move cursor left. # to move cursor right. Setting Data (Allow): Class 1 to Class 4: 01 to 99 sec (00= No Limit)	Default values: Class 1 to Class 4 = 00 secs (00 = No Limit)
<b>4</b>	Press <b>Transfer</b> to write the data.	
<b>5</b>	Press <b>Speaker</b> to go back on-line.	

**Related Programming**

M.B. Number	Memory Block Name
4-01	CO/PBX Ring Assignment (Day Mode)
4-02	CO/PBX Ring Assignment (Night Mode)
4-71	Time Class Assignment for Telephone Mode (R2000 and above)

N

Example:

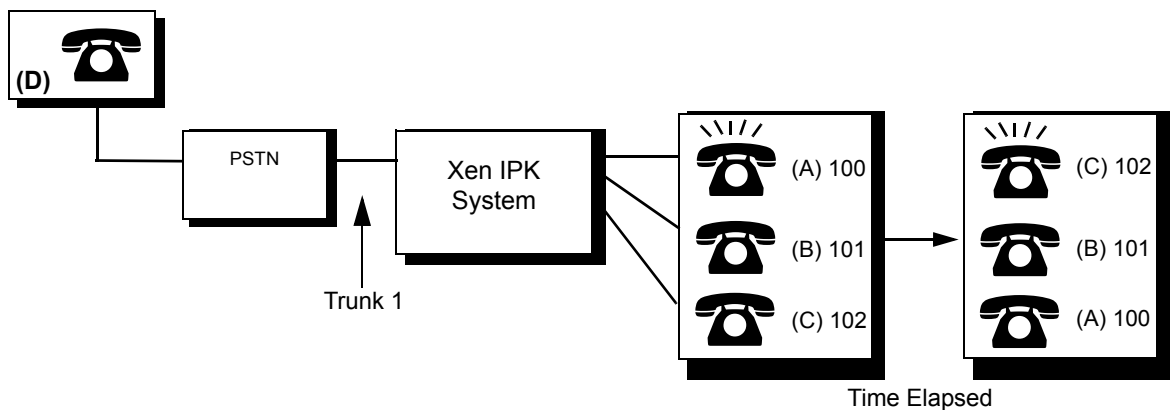

In this example, Public Switching Telephone Network (PSTN) and the system are connected by Trunk 1. Stations A (extension 100) and C (extension 102) are ring assigned to Trunk 1. Trunk 1 is assigned to Automated Attendant trunk.

1. To speak to station user A, the outside user D dials the telephone number for TRUNK 1, confirms the Automated Attendant message, and dials extension 100.
2. In the example at station A:
  - Ⓛ The ICM LED blinks and a ring tone that is different from the normal ringing tone is heard.
  - Ⓛ The call can be answered by lifting the handset.
  - Ⓛ Station users B and C cannot answer the call by pressing the line key on the Multiline Terminals.
3. In the example, if station user A does not answer in the specified time:
  - Ⓛ The ringing tone changes to the normal tone and station C starts ringing.
  - Ⓛ Any station (A, B, or C) user can answer the call by pressing the flashing line key.
4. Selecting No Limit ( $\infty$ ) disables this feature.

# Automated Attendant No Answer Disconnect Time Selection

*System Mode*  
**1**  
*Submode*  
**4**  
*Data No.*  
**03**  
*PC Programming*  
 + AU

## General Description

Use this Memory Block to establish how long the Automated Attendant rings a station before automatically disconnecting the caller.

With IPK R2000 and above, this memory block allows flexible entry.

*For R2000 only.*

## Display

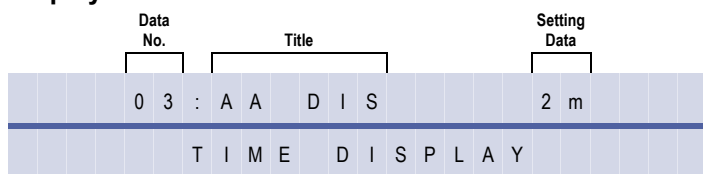





## Settings

LK 1	LK 2	LK 3	LK 4
1 min.	2 min.	3 min.	4 min.
LK 5	LK 6	LK 7	LK 8

The shaded area indicates the default setting.

## Programming Procedures



- 1 Go off-line.
- 2 Press LK1 + LK4 +   to access the Memory Block.
- 3 Press the corresponding CO/PBX line key to change the data option.
- 4 Press  to write the data.
- 5 Press  to go back on-line.

*For R2000 and above.*

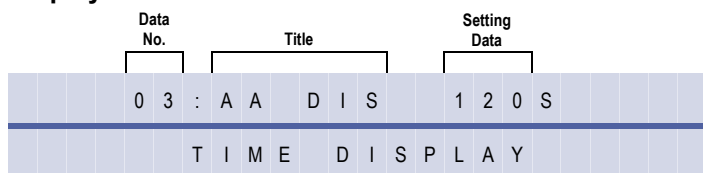
## Display



## Programming Procedures

- 1 Go off-line.
- 2 Press LK1 + LK4 +   to access the Memory Block.

**Programming Procedures**

<b>3</b>	Use the dial pad to enter the time required. <i>Note:</i> * to move cursor left. # to move cursor right. Setting Data (Allow): 001 to 255 sec	Default value: 120 sec
<b>4</b>	Press <b>Transfer</b> to write the data.	
<b>5</b>	Press <b>Speaker</b> to go back on-line.	

**Related Programming**

M.B. Number	Memory Block Name
	Refer to <i>Chapter 2, Guide to Feature Programming</i> .
<b>3-42</b>	Automatic Release Selection
<b>4-71</b>	Time Class Assignment for Telephone Mode (R2000 and above)

**N**

1. If the called party does not answer in the predetermined time, the call is dropped.
2. If Busy Tone Detector is enabled in Memory Block, 3-39, then disconnection of an abandoned call during an Automated Attendant message will be performed by the Trunk Card.
3. If Busy Tone Detector is not enabled, then Abandoned Call will continue to ring in the system for the duration of the time set in Memory Block , 1-4-03.

# Tandem Transfer SMDR Print Extension Assignment

System Mode  
**1**

Submode  
**4**

Data No.  
**04**

PC Programming  
 + AT







## General Description

Use this Memory Block to specify a special number to be output from Station Message Detail Recording (SMDR) to indicate an automatic Trunk-to-Trunk transfer.

## Display

Data No.	Title	Setting Data
04	T A N D E M	= 999
T I M E D I S P L A Y		

## Programming Procedures

<b>1</b>	Go off-line.	
<b>2</b>	Press LK1 + LK4 +   to access the Memory Block.	
<b>3</b>	Use the dial pad to enter the Table Number and Setting Data. <b>Note:</b> Use the following to enter data: <ul style="list-style-type: none"> <li> to move the cursor left</li> <li> to move the cursor right</li> </ul> <b>Setting Data Allowed</b> 2-Digit Number:00~99 3-Digit Number:000~999 4-Digit Number:0000~9999	<b>Default Values</b> 3-digit number = 999
<b>4</b>	Press  to write the data.	
<b>5</b>	Press  to go back on-line.	

## Related Programming

M.B. Number	Memory Block Name
<b>1-2-03</b>	2-, 3-, or 4-Digit Station Number Selection



1. When the system is powered up initially, this block defaults to 3-digit number 999.
2. If 2-digit station numbers are selected, this block defaults to 99.
3. If 4-digit station numbers are selected, this block defaults to 9999.

# Automatic Tandem Trunk by Night Mode Selection

## General Description

This Memory Block is used to establish whether or not the Automatic Trunk-to-Trunk Transfer feature follows the Night Mode assignment.

## Display

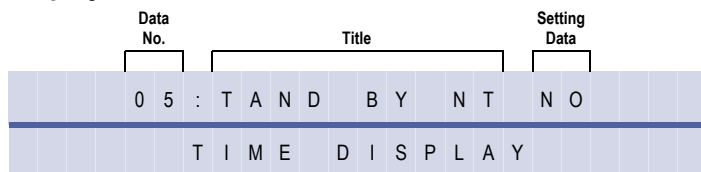





*System Mode*  
**1**  
*Submode*  
**4**  
*Data No.*  
**05**  
*PC Programming*  
 + AT

## Settings

LK 1	LK 2	LK 3	LK 4
No	Yes		
LK 5	LK 6	LK 7	LK 8

The shaded area indicates the default setting.

## Programming Procedures

- 1 Go off-line.
- 2 Press LK1 + LK4 +   to access the Memory Block.
- 3 Press the corresponding CO/PBX line key to change the data option.
- 4 Press  to write the data.
- 5 Press  to go back on-line.

## Related Programming

M.B. Number	Memory Block Name
1-1-27	Automatic Day/Night Mode Switching Time Assignment
1-1-33	Speed Dial Number/Name Display Selection
3-05	Trunk Incoming Answer Mode Selection
3-06	Automatic Tandem Trunk Assignment

# Automated Attendant PBR Timeout Response Selection

System Mode  
**1**

Submode  
**4**

Data No.  
**08**

PC Programming  
 + AU

## General Description

Use this Memory Block to specify how a call answered by the Automated Attendant should be processed if a dual-tone multifrequency (DTMF) tone is not received.

## Display





Data No.	Title	Setting Data
08	AA RES	NORMAL
TIME DISPLAY		

## Settings

LK 1	LK 2	LK 3	LK 4
Normal Call	Release		
LK 5	LK 6	LK 7	LK 8

The shaded area indicates the default setting.

## Programming Procedures

1	Go off-line.
2	Press LK1 + LK4 +   to access the Memory Block.
3	Press the corresponding CO/PBX line key to change the data option.
4	Press  to write the data.
5	Press  to go back on-line.

## Related Programming

M.B. Number	Memory Block Name
	Refer to <i>Chapter 2, Guide to Feature Programming.</i>

## N

1. When Normal Call is selected, and a DTMF tone is not received during the Automated Attendant message or during the Automated Attendant Push Button Receiver (PBR) Release Timer time (20-second default), the system rings selected stations using Memory Block 4-01 [CO/PBX Ring Assignment (Day Mode)] or Memory Block , 4-02 , CO/PBX Ring Assignment (Night Mode).
2. When Release is selected, and a DTMF tone is not received during the Automated Attendant message or during the Automated Attendant PBR Release Timer time (20-second default), the system drops the call after 30 seconds regulated by a fixed timer.

# Automated Attendant PBR Start Time Selection

## General Description

This Memory Block is used to specify whether the Push Button Receiver (PBR) can receive dual-tone multi frequency (DTMF) signalling while the Automated Attendant is sending the message or after the message is complete.

## Display

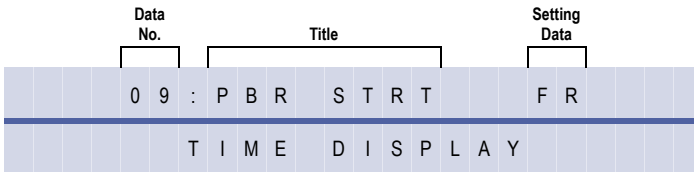





## Settings

LK 1	LK 2	LK 3	LK 4
FR	AF		
LK 5	LK 6	LK 7	LK 8

The shaded area indicates the default setting.

## Programming Procedures

1	Go off-line.
2	Press LK1 + LK4 +   to access the Memory Block.
3	Press the corresponding CO/PBX line key to change the data option. Setting Data: FR: While the Automated Attendant sends the message. AF: After the Automated Attendant sends the message.
4	Press  to write the data.
5	Press  to go back on-line.

## Related Programming

M.B. Number	Memory Block Name
	Refer to <i>Chapter 2, Guide to Feature Programming</i> .

System Mode

1

Submode

4

Data No.

09

PC Programming



+ AU

N

When FR is assigned, the Automated Attendant message send start time and the PBR connected to Automated Attendant trunk start time are the same.

# Automated Attendant Message Day Night Mode Selection

## General Description

Use this Memory Block to specify Automated Attendant messages that are available for use in a Day/Night Mode setting.

## Display

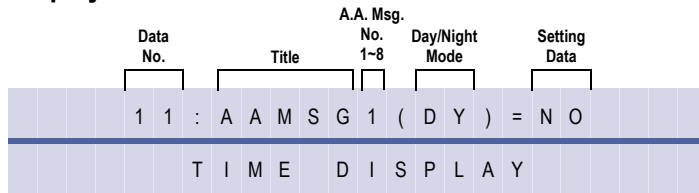

System Mode  
**1**

Submode  
**4**

Data No.  
**11**







PC Programming  
 + AU

## Settings

LK 1	LK 2	LK 3	LK 4
Yes	No		
LK 5	LK 6	LK 7	LK 8

The shaded area indicates the default setting.

## Programming Procedures

- 1 Go off-line.
- 2 Press LK1 + LK4 +   to access the Memory Block.
- 3 Press the corresponding CO/PBX line key to change data option.  
Use the dial pad to enter A.A. message number.  
**Note:** Use the following to enter data:  
 ~  to enter numerical data  
 to toggle between Day Mode and Night Mode
- 4 Press  to write the data.
- 5 Press  to go back on-line.

## Related Programming

M.B. Number	Memory Block Name
	Refer to <i>Chapter 2, Guide to Feature Programming.</i>



1. This Memory Block must be set to YES for Automated Attendant to be enabled.



# Automated Attendant Message to Tenant Assignment

## General Description

Use this Memory Block to assign Automated Attendant Messages to Tenant.

## Display

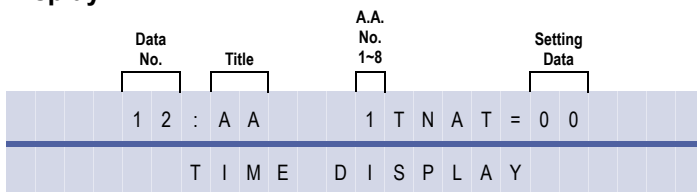

System Mode  
**1**

Submode  
**4**

Data No.  
**12**

PC Programming  
 + AU

## Programming Procedures

1	Go off-line.	
2	Press LK1 + LK4 +   to access the Memory Block.	
3	Use the dial pad to enter data. <b>Note:</b> Use the following to enter data: ~  to enter Automated Attendant message number. ~  to enter Tenant Number.	<b>Default Values</b> All Automated Attendant Messages: Tenant No. 00
4	Press  to write the data.	
5	Press  to go back on-line.	

## Related Programming

M.B. Number	Memory Block Name
	Refer to <i>Chapter 2, Guide to Feature Programming</i> .

# N

If a tenant is not assigned to a specific automated message, the Automated Attendant sends the message assigned in Memory Block , 1-4-11 , Automated Attendant Message Day Night Mode Selection.

# Automated Attendant Answer Delay Time Assignment

## General Description

Use this Memory Block to assign the number of seconds before the Automated Attendant answers an incoming CO/PBX call.

## Display

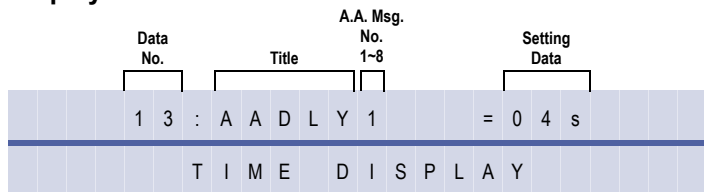

System Mode  
**1**

Submode  
**4**

Data No.  
**13**

PC Programming  
 + AU

## Programming Procedures

1	Go off-line.	
2	Press LK1 + LK4 +   to access the Memory Block.	
3	Use the dial pad to enter data. <b>Note:</b> Use the following to enter data: ~  to enter Automated Attendant message number ~  to enter number of seconds.	<b>Default Values</b> All Automated Attendant Messages: 4 sec.
4	Press  to write the data, and advance to the next A.A.No.	
5	After the last entry, press  to write the data.	
6	Press  to go back on-line.	

## Related Programming

M.B. Number	Memory Block Name
	Refer to <i>Chapter 2, Guide to Feature Programming.</i>

# Automated Attendant Message Access Code (1-Digit) Assignment

*System Mode*  
**1**  
*Submode*  
**4**  
*Data No.*  
**14**  
*PC Programming*  
 + AU









### General Description

Use this Memory Block to enter a 1-digit code to route an incoming call from the Automated Attendant.

### Display

Data No.	Title	A.A. Msg. No. 1-8	Dial No. 0-9	Setting Data
14	AAAC	1	0	030
T I M E D I S P L A Y				







### Programming Procedures

<b>1</b>	Go off-line.																		
<b>2</b>	Press LK1 + LK4 +   to access the Memory Block.																		
<b>3</b>	<div style="display: flex; justify-content: space-between;"> <div style="width: 60%;"> <p>Use the dial pad to enter data.</p> <p><b>Note:</b> Use the following to enter data:</p> <ul style="list-style-type: none"> <li> ~  to enter Automated Attendant message number</li> <li> ~  to enter dial number</li> </ul> <p><b>Setting Data Allowed</b> Function Code 001~053 sec.</p> <p><b>Note:</b> 000 is unused.</p> </div> <div style="width: 35%; border: 1px solid black; padding: 5px;"> <p style="text-align: center; margin: 0;"><b>Default Values</b></p> <table border="1" style="width: 100%; border-collapse: collapse; text-align: center;"> <thead> <tr> <th style="width: 15%;">Dial Number</th> <th style="width: 15%;">Function Code</th> <th style="width: 70%;">Contents</th> </tr> </thead> <tbody> <tr> <td>9</td> <td>030</td> <td>Specified Station Call (0)</td> </tr> <tr> <td>1</td> <td>010</td> <td>Station Number</td> </tr> <tr> <td>2</td> <td>010</td> <td>Station Number</td> </tr> <tr> <td>3</td> <td>010</td> <td>Station Number</td> </tr> <tr> <td>0,4 ~ 8</td> <td>000</td> <td>Unregistered</td> </tr> </tbody> </table> </div> </div>	Dial Number	Function Code	Contents	9	030	Specified Station Call (0)	1	010	Station Number	2	010	Station Number	3	010	Station Number	0,4 ~ 8	000	Unregistered
Dial Number	Function Code	Contents																	
9	030	Specified Station Call (0)																	
1	010	Station Number																	
2	010	Station Number																	
3	010	Station Number																	
0,4 ~ 8	000	Unregistered																	
<b>4</b>	Press  to write the data and advance to the next dial number then to each Automated Attendant number.																		
<b>5</b>	After all data is entered, press  to write the data.																		
<b>6</b>	Press  to go back on-line.																		

### Related Programming

M.B. Number	Memory Block Name
	Refer to <i>Chapter 2, Guide to Feature Programming.</i>

## N

1. Function 011 (Bypass Automated Attendant) uses Memory Blocks , 4-01 , CO/PBX Ring Assignment (Day Mode) and , 4-02 , CO/PBX Ring Assignment (Night Mode) to ring according to those assignments.
2. Functions 015~016 (Ring Internal Paging Zone A/B/C) require assigning the following to ring the desired station:  
Memory Block 4-01 [CO/PBX Ring Assignment (Day Mode)]  
Memory Block 4-02 [CO/PBX Ring Assignment (Night Mode)]  
Memory Block 4-93 (Internal Zone Paging Selection).
3. If a caller receives a busy signal after being transferred by the Automated Attendant, the following Fixed Access Codes apply:
  -   Step Call
  -   Receive a second dial tone
  -   CO rings based on Day/Night Ring Assignment

## 1-Digit Access Codes

Function Code	Contents	Function Code	Contents
000	Unregistered	027	
001	Automatic Attendant Message (1)	028	
002	Automatic Attendant Message (2)	029	
003	Automatic Attendant Message (3)	030	Specified Station Call (00). Refer to Memory Block 1-2-08 (Specified Station Access Code Assignment)
004	Automatic Attendant Message (4)	031	Specified Station Call (01)
005	Automatic Attendant Message (5)	032	Specified Station Call (02)
006	Automatic Attendant Message (6)	033	Specified Station Call (03)
007	Automatic Attendant Message (7)	034	Specified Station Call (04)
008	Automatic Attendant Message (8)	035	Specified Station Call (05)
009		036	Specified Station Call (06)
010	Internal Number (Station Number)	037	Specified Station Call (07)
011	Bypass Automated Attendant	038	Specified Station Call (08)
012		039	Specified Station Call (09)
013		040	Specified Station Call (10)
014		041	Specified Station Call (11)
015	Paging Zone A Call	042	Specified Station Call (12)
016	Paging Zone B Call	043	Specified Station Call (13)
017	Paging Zone C Call	044	Specified Station Call (14)
018		045	Specified Station Call (15)
019		046	Specified Station Call (16)

## 1-Digit Access Codes (Continued)

Function Code	Contents	Function Code	Contents
020	DSS 1 Call	047	Specified Station Call (17)
021	DSS 2 Call	048	Specified Station Call (18)
022	DISA Access Code	049	Specified Station Call (19)
023		050	Specified Station Call (20)
024		051	Specified Station Call (21)
025		052	Specified Station Call (22)
026		053	Specified Station Call (23)

# Automated Attendant Message Access Code (2-Digit) Assignment

*System Mode*  
**1**  
*Submode*  
**4**  
*Data No.*  
**15**  
*PC Programming*  
 + AU











## General Description

Use this Memory Block to enter a 2-digit code to route an incoming call from the Automated Attendant.

## Display

Data No.	Title	A.A. Msg. No. 1-8	Dial No.	Setting Data
15	AA	AC1	=00	=030
T I M E D I S P L A Y				

## Programming Procedures

1	Go off-line.																														
2	Press LK1 + LK4 +   to access the Memory Block.																														
3	<div style="display: flex; justify-content: space-between;"> <div style="width: 60%;"> <p>Use the dial pad to enter data.</p> <p><b>Note:</b> The following are used when entering data:</p> <p> ~  to enter Automated Attendant message number</p> <p>  ~  to enter dial number</p> </div> <div style="width: 35%;"> <p><b>Default Values</b></p> <table border="1" style="width: 100%; border-collapse: collapse; text-align: center;"> <thead> <tr> <th>Dial No.</th> <th>Funct. Code</th> <th>Contents</th> </tr> </thead> <tbody> <tr> <td>00 ~ 50</td> <td>030</td> <td>Specified Station Cal (0)</td> </tr> <tr> <td>51</td> <td>011</td> <td>Bypass Automated Attendant</td> </tr> <tr> <td>52</td> <td>015</td> <td>Paging Zone A Call</td> </tr> <tr> <td>53</td> <td>016</td> <td>Paging Zone B Call</td> </tr> <tr> <td>54</td> <td>017</td> <td>Paging Zone C Call</td> </tr> <tr> <td>55 ~ 87</td> <td>000</td> <td>Not Used</td> </tr> <tr> <td>88</td> <td>020</td> <td>DSS 1 Call</td> </tr> <tr> <td>89</td> <td>021</td> <td>DSS 2 Call</td> </tr> <tr> <td>90~99</td> <td>000</td> <td>Not Used</td> </tr> </tbody> </table> </div> </div>	Dial No.	Funct. Code	Contents	00 ~ 50	030	Specified Station Cal (0)	51	011	Bypass Automated Attendant	52	015	Paging Zone A Call	53	016	Paging Zone B Call	54	017	Paging Zone C Call	55 ~ 87	000	Not Used	88	020	DSS 1 Call	89	021	DSS 2 Call	90~99	000	Not Used
Dial No.	Funct. Code	Contents																													
00 ~ 50	030	Specified Station Cal (0)																													
51	011	Bypass Automated Attendant																													
52	015	Paging Zone A Call																													
53	016	Paging Zone B Call																													
54	017	Paging Zone C Call																													
55 ~ 87	000	Not Used																													
88	020	DSS 1 Call																													
89	021	DSS 2 Call																													
90~99	000	Not Used																													
4	Enter Setting Data. Press  to write the data and to advance the Dial Number.																														
5	After all data is entered, press  to write the data.																														
6	Press  to go back on-line.																														

## Related Programming

M.B. Number	Memory Block Name
	Refer to <i>Chapter 2, Guide to Feature Programming.</i>



To use default 52~54, ringing must be assigned in Memory Blocks 4-01 [CO/PBX Ring Assignment (Day Mode)] or 4-02 [CO/PBX Ring Assignment (Night Mode)] .

# Automated Attendant Message Repeat Selection

## General Description

Use this Memory Block to specify the number of times a message from the Automated Attendant is repeated to the calling party.

## Display

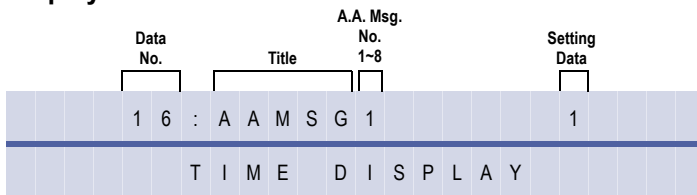

System Mode  
**1**

Submode  
**4**

Data No.  
**16**

PC Programming  
 + AU

## Settings

LK 1	LK 2	LK 3	LK 4
One Time	Two Times	Three Times	Four Times
LK 5	LK 6	LK 7	LK 8
Five Times	Six Times	Seven Times	Eight Times

The shaded area indicates the default setting.

## Programming Procedures

1	Go off-line.	
2	Press LK1 + LK4 +   to access the Memory Block.	
3	Press the corresponding CO/PBX line to change data option.	<b>Default Values</b> All Messages One Time
4	Press  to write the data and advance to next Automated Attendant Number.	
5	After all data is entered, press  to write the data.	
6	Press  to go back on-line.	

## Related Programming

M.B. Number	Memory Block Name
	Refer to <i>Chapter 2, Guide to Feature Programming</i> .

# Automated Attendant Delay Announcement Hold Tone Selection

*System Mode*  
**1**  
*Submode*  
**4**  
*Data No.*  
**17**  
*PC Programming*  
 + AU

## General Description

Use this Memory Block to specify the tone that is sent to the outside party after the Automated Attendant Delay Announcements are played.

## Display



Data No.	Title	Setting Data
17	AA HOLD	RBT
TIME DISPLAY		

## Settings

LK 1	LK 2	LK 3	LK 4
RBT	MOH		
LK 5	LK 6	LK 7	LK 8

The shaded area indicates the default setting.

## Programming Procedures

<b>1</b>	Go off-line.	
<b>2</b>	Press LK1 + LK4 +  to access the Memory Block.	
<b>3</b>	Press the corresponding CO/PBX line to change data option. <b>Example:</b> To change RBT to MOH, press CO/PBX line key 2.	<b>Default Values</b> All Messages One Time
<b>4</b>	Press  to write the data and advance to Memory Block , 1-4-18 , Automated Attendant Delay Announcement Assignment	
<b>5</b>	Press  to go back on-line.	

## Related Programming

M.B. Number	Memory Block Name
<b>1-4-18</b>	Automated Attendant Delay Announcement Assignment
<b>1-4-19</b>	Automated Attendant 1st to 2nd Delay Announcement Interval Time Selection
<b>1-4-20</b>	Automated Attendant Delay Announcement Disconnect Time Selection



# Automated Attendant Delay Announcement Assignment

## General Description

Use this Memory Block to specify the order for the Automated Attendant messages that are played when in the Delayed Announcement Mode.

## Display

Data No.	1st Message No.	Title	Setting Data 2nd Message No.
1 8 :	( 1 )	2 N D =	N O N E
T I M E D I S P L A Y			

System Mode  
**1**

Submode  
**4**

Data No.  
**18**









PC Programming  
 + AU

## Settings

LK 1	LK 2	LK 3	LK 4
Not Specified (NONE)	MSG1	MSG2	MSG3
LK 5	LK 6	LK 7	LK 8
MSG4	MSG5	MSG6	MSG7
LK9	LK10	LK11	LK12
MSG8			

The shaded area indicates the default setting.

## Programming Procedures

1	Go off-line.	
2	Press LK1 + LK4 +   to access the Memory Block.	
3	Use the dial pad to enter the 1st message number. Use the Line Key to enter the Setting Data. <b>Note:</b> Use the following to enter data: <ul style="list-style-type: none"> <li> to move the cursor left</li> <li> to move the cursor right</li> <li> ~  to enter numeric data</li> </ul>	<b>Default Values</b> 1st Message No. 1~8 : Not Specified
4	Pressing  will write the selected data and advance to Memory Block , 1-4-19 , Automated Attendant 1st to 2nd Delay Announcement Interval Time Selection	
5	Press  to go back on-line.	

## Related Programming

M.B. Number	Memory Block Name
<b>1-4-19</b>	Automated Attendant 1st to 2nd Delay Announcement Interval Time Selection
<b>1-4-20</b>	Automated Attendant Delay Announcement Disconnect Time Selection

Doc. No.: 8194 - Release 2.0  
December 2004



1. This Memory Block must be set to YES for Automated Attendant to be enabled.
2. This Feature is **not** related to Memory Block , 3-43 , ACD/UCD Delay Announcement Assignment.

# Automated Attendant 1<sup>st</sup> to 2<sup>nd</sup> Delay Announcement Interval Time Selection

*System Mode*  
**1**  
*Submode*  
**4**  
*Data No.*  
**19**  
*PC Programming*  
 + AU

### General Description

Use this Memory Block to specify the interval time between the Automated Attendant Delay Announcement messages.

### Display





Data No.	Title	Setting Data
19	1 s t I N T R V L	4 m
T I M E D I S P L A Y		

### Settings

LK 1	LK 2	LK 3	LK 4
Immediate (0s)	10 sec. (10s)	20 sec. (20s)	30 sec. (30s)
LK 5	LK 6	LK 7	LK 8
1 min. (1m)	2 min. (2m)	3 min. (3m)	4 min. (4m)
LK 9	LK 10	LK 11	LK 12
5 min. (5m)	10 min. (10m)	20 min. (20m)	

The shaded area indicates the default setting.

### Programming Procedures

1	Go off-line.	
2	Press LK1 + LK4 +   to access the Memory Block.	
3	Press the corresponding CO/PBX line key to change the data option. <b>Example:</b> To change 4 minutes to 10 seconds, press CO/PBX line key 2.	<b>Default Values</b> 4 min.
4	Press  to write the selected data and advance to Memory Block , 1-4-20 , Automated Attendant Delay Announcement Disconnect Time Selection.	
5	Press  to go back on-line.	

### Related Programming

M.B. Number	Memory Block Name
1-4-18	Automated Attendant Delay Announcement Assignment
1-4-20	Automated Attendant Delay Announcement Disconnect Time Selection

# Automated Attendant Delay Announcement Disconnect Time Selection

System Mode  
**1**

Submode  
**4**

Data No.  
**20**

PC Programming



## General Description

Use this Memory Block to establish how long the Automated Attendant rings the stations before disconnecting the caller. This Memory Block only applies when the Automated Attendant is set to the Delay Announcement Mode.

## Display

Data No.	Title	Setting Data
20	2 n d I N T R V L	30 s
T I M E D I S P L A Y		

## Settings

LK 1	LK 2	LK 3	LK 4
Immediate (0s)	10 sec. (10s)	20 sec. (20s)	30 sec. (30s)
LK 5	LK 6	LK 7	LK 8
1 min. (1m)	2 min. (2m)	3 min. (3m)	4 min. (4m)
LK9	LK10	LK11	LK12
5 min. (5m)	10 min. (10m)	20 min. (20m)	

The shaded area indicates the default setting.

## Programming Procedures

1	Go off-line.
2	Press LK1 + LK4 +   to access the Memory Block.
3	Press the corresponding CO/PBX line key to change the data option. <b>Default Values</b> Specified in the shaded area.
4	Press  to write the selected data and advance to Memory Block , 1-5-02 , SMDR Print Format.
5	Press  to go back on-line.

## Related Programming

M.B. Number	Memory Block Name
1-4-18	Automated Attendant Delay Announcement Assignment
1-4-19	Automated Attendant 1st to 2nd Delay Announcement Interval Time Selection

# Automated Attendant Extension Number Assignment

*System Mode*  
**1**  
*Submode*  
**4**  
*Data No.*  
**21**  
*PC Programming*  
 + AU







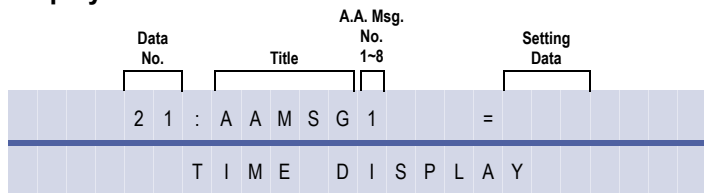

## General Description

Use this Memory Block to assign the extension number of each AA message.

## Display



## Programming Procedures

<b>1</b>	Go off-line.		
<b>2</b>	Press LK1 + LK4 +   to access the Memory Block.		
<b>3</b>	Use the dial pad to enter data. <b>Note:</b> Use the following to enter data:  ~  to enter Automated Attendant message number 2-Digit Station Number: 10~99 3-Digit Station Number: 100~999 4-Digit Station Number: 1000~9999  to clear all data when cursor is at setting position (Depends what length the extension number has been assigned in MB1-2-03.)	<b>Default Values</b> Not assigned.	
<b>4</b>	Press  to write the data, and advance to the next A.A.No.		
<b>5</b>	After the last entry, press  to write the data.		
<b>6</b>	Press  to go back on-line.		

## Related Programming

M.B. Number	Memory Block Name
	Refer to <i>Chapter 2, Guide to Feature Programming.</i>



1. Extension number cannot be the same as the physical extension, CAR, ACD/UCD/SCD pilot number.

# Automated Attendant Direct Extension Ring or Ring Assignment

System Mode  
**1**

Submode  
**4**

Data No.  
**22**

PC Programming



## General Description

Use this Memory Block to ring at an extension or normal ringing after the AA PBR timer expires

## Display

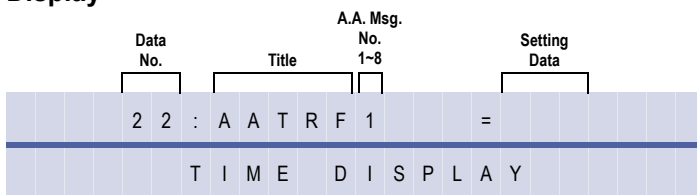

## Programming Procedures

<b>1</b>	Go off-line.		
<b>2</b>	Press LK1 + LK4 +   to access the Memory Block.		
<b>3</b>	Use the dial pad to enter data. <b>Note:</b> Use the following to enter data: <ul style="list-style-type: none"> <li> to move the cursor LEFT</li> <li> to move the cursor RIGHT</li> <li> ~  to enter numeric data</li> <li>2-Digit Station Number: 10~99</li> <li>3-Digit Station Number: 100~999</li> <li>4-Digit Station Number: 1000~9999</li> <li>H to clear all data when cursor is at setting position (Depends what length the extension number has been assigned in HB1-2-03.)</li> </ul>	<b>Default Values</b> Not assigned.	
<b>4</b>	Press  to write the data, and advance to the next A.A.No.		
<b>5</b>	After the last entry, press  to write the data.		
<b>6</b>	Press  to go back on-line.		

## Related Programming

M.B. Number	Memory Block Name
	Refer to <i>Chapter 2, Guide to Feature Programming</i> .

## N

1. If extension number is not assigned, then the system follows the assignment of MB 1-4-08 (release or becomes a normal call).
2. The extension number can be physical, CAR or AA message.

THIS PAGE INTENTIONALLY LEFT BLANK

# SMDR Print Format

## General Description

Use this Memory Block to specify whether or not ALL digits are to be printed. If All is specified, all digits are printed. If MASK is specified, the last four digits are masked and XXXX is printed.

## Display

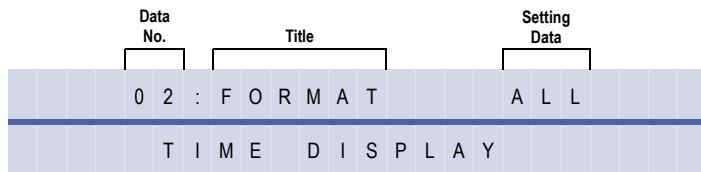





*System Mode*  
**1**  
*Submode*  
**5**  
*Data No.*  
**02**  
*PC Programming*  
 + AS

## Settings

LK 1	LK 2	LK 3	LK 4
All	Mask		
LK 5	LK 6	LK 7	LK 8

The shaded area indicates the default setting.

## Programming Procedures

- 1 Go off-line.
- 2 Press LK1 + LK5 +   to access the Memory Block.
- 3 Press the corresponding CO/PBX line key to change the data option.
- 4 Press  to write the data.
- 5 Press  to go back on-line.

## Related Programming

M.B. Number	Memory Block Name
1-5-13	Printer Connected Selection

# Printer Connected Selection

## General Description

Use this Memory Block to program when a printer or PC is connected for SMDR use. If the printer is disconnected from the system, an alarm sounds at stations connected to Ports 01 and 02.

## Display

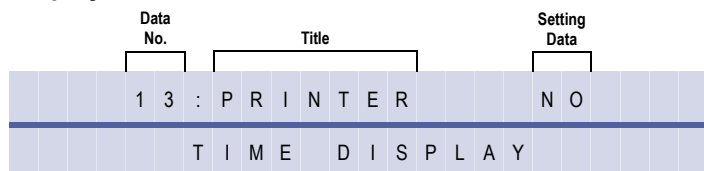





*System Mode*  
**1**  
*Submode*  
**5**  
*Data No.*  
**13**  
*PC Programming*  
 + AS

## Settings

LK 1	LK 2	LK 3	LK 4
No	PC	Printer	
LK 5	LK 6	LK 7	LK 8

The shaded area indicates the default setting.

## Programming Procedures

- 1 Go off-line.
- 2 Press LK1 + LK5 +   to access the Memory Block.
- 3 Press the corresponding CO/PBX line key to change the data option.
- 4 Press  to write the data.
- 5 Press  to go back on-line.

## Related Programming

M.B. Number	Memory Block Name
1-5-02	SMDR Print Format
1-5-14	Printer Line Feed Control Selection
1-5-23	Outgoing Mode Selection
1-5-25	SMDR Valid Call Timer Assignment
1-8-35	COM Port Baud Rate Setting Assignment
1-8-36	COM Port Parity/Stop Bit Setting Assignment



1. Station Message Detail Recording (SMDR) cannot be used if this Memory Block is programmed for No.
2. When PC is assigned, the SMDR output data can be saved in a Comma-Separated Values (CSV) format file on a PC. The file can then be opened using PC software (i.e., MS Excel) to analyze, filter, and/or sort the data.



# Printer Line Feed Control Selection

## General Description

This Memory Block specifies the format of the data sent to the Station Message Detail Recording (SMDR) printer. If YES is set, a carriage return is provided with the call record.

## Display

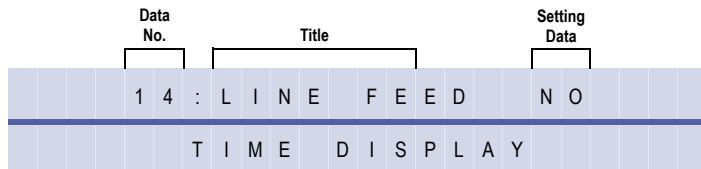

System Mode  
**1**

Submode  
**5**

Data No.  
**14**





PC Programming  
 + AS

## Settings

LK 1	LK 2	LK 3	LK 4
Yes	No		
LK 5	LK 6	LK 7	LK 8

The shaded area indicates the default setting.

## Programming Procedures

- 1 Go off-line.
- 2 Press LK1 + LK5 +   to access the Memory Block.
- 3 Press the corresponding CO/PBX line key to change the data option.
- 4 Press  to write the data.
- 5 Press  to go back on-line.

## Related Programming

M.B. Number	Memory Block Name
<b>1-5-02</b>	SMDR Print Format
<b>1-5-13</b>	Printer Connected Selection
<b>1-5-25</b>	SMDR Valid Call Timer Assignment

# N

**Example:** Settings to specify the format of communication data output to the printer.

 Line Feed control in effect.

```
07/03/92    09:00    08-05-12    OG 123
00:15:32    102885167537000    LCR    FWD234
12345678
```

 No Line Feed control.

```
07/03/92    09:00    08-05-12    OG 123    00:15:32    10288516753700    LCR    IWD234
12345678
(No Limit)
```

# Outgoing Mode Selection

## General Description

Use this Memory Block to specify whether a station's Extension Number or ID Number is to be printed in SMDR call records. Also, setting this to "ID" allows use of the Code Restriction Password Override facility, in preference to the Forced Account Code facility.

## Display

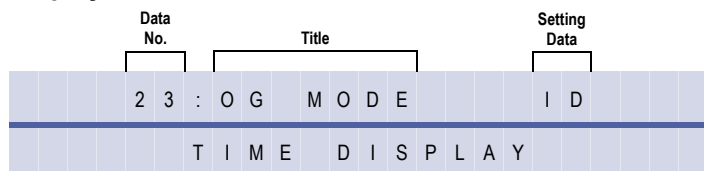





*System Mode*  
**1**  
*Submode*  
**5**  
*Data No.*  
**23**  
*PC Programming*  
 + AS

## Settings

LK 1	LK 2	LK 3	LK 4
TEL	ID		
LK 5	LK 6	LK 7	LK 8

The shaded area indicates the default setting.

## Programming Procedures

- 1 Go off-line.
- 2 Press LK1 + LK5 +   to access the Memory Block.
- 3 Press the corresponding CO/PBX line key to change the data option.
- 4 Press  to write the data.
- 5 Press  to go back on-line.

## Related Programming

M.B. Number	Memory Block Name
1-1-19	Line Selection for Automatic Outgoing Calls
1-1-46	DID Digit Length Selection
1-1-47	DID Digit Conversion Assignment
1-1-48	DID Forward Station Number for Busy Station or Undefined Digit
1-8-08	Class of Service (Station) Feature Selection 2
1-9-00	DISA/ID Code Assignment
1-9-02	DISA/ID Password Effect/Invalid Selection
1-9-03	ID Restriction Class Assignment (Day Mode)
1-9-04	ID Restriction Class Assignment (Night Mode)
4-26	DISA/ID Number Station Assignment
4-27	ID Outgoing Restriction Selection

Doc. No.: 8194 - Release 2.0  
December 2004

# SMDR Valid Call Timer Assignment

## General Description

Use this Memory Block to assign the minimum length of a call before the Station Message Detail Recording (SMDR) outputs a record of the outgoing CO/PBX call.

## Display

Data No.	Title	Setting Data
25	SMDR	TIM = 000S
TIME DISPLAY		





System Mode  
**1**

Submode  
**5**

Data No.  
**25**

PC Programming  
 + AS

## Programming Procedures

1	Go off-line.	
2	Press LK1 + LK5 +   to access the Memory Block.	
3	Use the dial pad to enter data.	<b>Default Values</b> 0 seconds
	<ul style="list-style-type: none"> <li>Minimum time assignment is 000 sec.</li> <li>Time assignment can be set from 000 sec.~990 sec. in increments of 10 (Setting Data: 00~99)</li> </ul>	
4	Press  to write the data.	
5	Press  to go back on-line.	

## Related Programming

M.B. Number	Memory Block Name
1-1-05	Start Timer Selection
1-5-13	Printer Connected Selection

# SMDR Incoming/Outgoing Print Selection

*System Mode*  
**1**

*Submode*  
**5**

*Data No.*  
**26**

*PC Programming*  
 + **AS**

## General Description

Use this Memory Block to specify the type of call records to be output from the Station Message Detail Recording (SMDR): OUT = print outgoing call records only, INC = print incoming call records only, ALL = print incoming and outgoing call records.

## Display

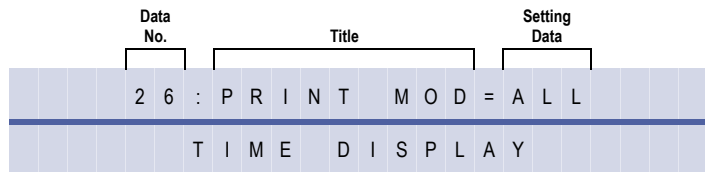





## Settings

LK 1	LK 2	LK 3	LK 4
All	Out	INC	
LK 5	LK 6	LK 7	LK 8

The shaded area indicates the default setting.

## Programming Procedures

- 1 Go off-line.
- 2 Press LK1 + LK5 +   to access the Memory Block.
- 3 Press the corresponding CO/PBX line key to change the data option.
- 4 Press  to write the data.
- 5 Press  to go back on-line.

## Related Programming

M.B. Number	Memory Block Name
1-5-13	Printer Connected Selection

# Attendant Add-On Console to Telephone Port Assignment

## General Description

Use this Memory Block to assign an Attendant Add-On Console to a telephone port number.

## Display

Data No.	Title	DSS No. 1-4	Setting Data
0 1	: D S S	1 = P	0 1
T I M E D I S P L A Y			



System Mode  
**1**

Submode  
**6**

Data No.  
**00**

PC Programming  
 + BTD

## Programming Procedures

<b>1</b>	Go off-line.															
<b>2</b>	Press LK1 + LK6.															
<b>3</b>	Use * to move cursor to the second Data No. position and press ! to access the Memory Block.															
<b>4</b>	Use the dial pad to enter the data. <b>Note:</b> Use the following to enter data: * to move the cursor left # to move the cursor right 0-9 to enter numeric data															
<b>Default Values</b>																
<table border="1" style="margin-left: auto; margin-right: auto;"> <thead> <tr> <th>DSS</th> <th></th> <th>Tel Port No.</th> </tr> </thead> <tbody> <tr> <td>1</td> <td style="text-align: center;">&gt;</td> <td>01</td> </tr> <tr> <td>2</td> <td style="text-align: center;">&gt;</td> <td>02</td> </tr> <tr> <td>3</td> <td style="text-align: center;">&gt;</td> <td>01</td> </tr> <tr> <td>4</td> <td style="text-align: center;">&gt;</td> <td>02</td> </tr> </tbody> </table>		DSS		Tel Port No.	1	>	01	2	>	02	3	>	01	4	>	02
DSS		Tel Port No.														
1	>	01														
2	>	02														
3	>	01														
4	>	02														
<b>5</b>	Press  to write the data.															
<b>6</b>	Change the data using the dial pad.															
<b>7</b>	Press  to write the data.															
<b>8</b>	Press  to go back on-line.															

## Related Programming

M.B. Number	Memory Block Name
<b>7-2</b>	Telephone Type Assignment

## N

1. The telephone with an Attendant Add-On Console connected must be specified by port number.
2. A maximum of four Attendant Add-On Consoles can be connected to a system.
3. A maximum of four Attendant Add-On Consoles can be connected to one telephone.

# DSS Call Voice/Tone Signal Selection

## General Description

Use this Memory Block to specify which is to be used first, Voice or Tone signalling, when calling an extension from an Attendant Add-On Console.

## Display

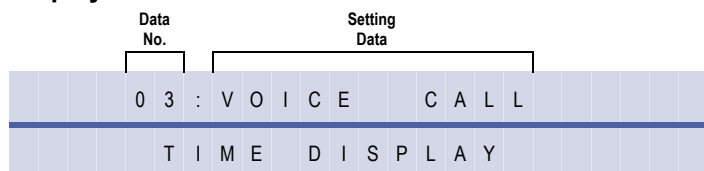

System Mode  
**1**

Submode  
**6**

Data No.  
**03**

PC Programming  
 + **BTD**

## Settings

LK 1	LK 2	LK 3	LK 4
Tone	Voice		
LK 5	LK 6	LK 7	LK 8

The shaded area indicates the default setting.

## Programming Procedures

1	Go off-line.
2	Press LK1 + LK6.
3	Use  to move cursor to the second Data No. position and press  to access the Memory Block.
4	Press the corresponding CO/PBX line key to change the data option.
5	Press  to write the data.
6	Press  to go back on-line.

## Related Programming

M.B. Number	Memory Block Name
1-6-00	Attendant Add-On Console to Telephone Port Assignment



1. Voice/tone signalling can also be switched by dialling 1 from a station.
2. If tone signalling is programmed in this Memory Block, the called party cannot answer handsfree unless the Direct Station Select (DSS) station switches it to Voice by dialling 1.

# Attendant Add-On Console Key Selection

## General Description

Use this Memory Block to assign functions to the Attendant Add-On Console keys.

## Display

Data No.	DSS No. 1-4	Button No. 01-60	Setting Data	Page No.
05	:	1 / 01	= CO 01	2
T I M E D I S P L A Y				

System Mode  
**1**

Submode  
**6**

Data No.  
**05**

PC Programming



## Settings

### (Page 1)

LK 1	LK 2	LK 3	LK 4
Vacant	TEL. No. 01~96	Internal Paging Zone A	Internal Paging Zone B
LK 5	LK 6	LK 7	LK 8
Internal Paging Zone C	All Internal Zone Paging	External Zone A	External Zone B

### (Page 2)

LK 1	LK 2	LK 3	LK 4
External Zone C	All External Zone Paging	Message Waiting	Night Mode Change
LK 5	LK 6	LK 7	LK 8
Transfer	Attendant Station Outgoing Lockout	Call Arrival Key	Trunk (01~64)

There is no default setting.

### (Page 3)

LK 1	LK 2	LK 3	LK 4
Live Recording Feature	Mail Box Number	Doorphone 1	Doorphone 2
LK 5	LK 6	LK 7	LK 8
GP Relay 0	GP Relay 1		

## Programming Procedures

<b>1</b>	Go off-line.
<b>2</b>	Press LK1 + LK6. Use $\odot$ to move cursor to the second Data No. position and press $\odot$ to access the Memory Block.

**Programming Procedures**

**3** Press the corresponding CO/PBX line key and dial pad keys to change the data option:

Functions can be assigned to keys 01~60 on Attendant Add-On Consoles 1~4.

Functions to be programmed:

- ☎ Station No. 01~96
- ☎ Internal Paging Zone A
- ☎ Internal Paging Zone B
- ☎ Internal Paging Zone C
- ☎ Internal Paging Zone ALL
- ☎ External Paging Zone A
- ☎ External Paging Zone B
- ☎ External Paging Zone C
- ☎ External Zone Paging ALL
- ☎ Message Waiting
- ☎ Night Mode Switching
- ☎ Trunk (01~64)
- ☎ Transfer
- ☎ Attendant Station Outgoing Lockout
- ☎ Call Arrival Key (01~88)
- ☎ Feature Access Key with Live Recording
- ☎ Digital Voice Mail Mailbox Number
- ☎ DPH 1 & 2
- ☎ General Purpose Relay 04

DSS Key Number						
1	2	3	4	5	6	
<input type="text"/>	<input type="text"/>	<input type="text"/>	<input type="text"/>	<input type="text"/>	<input type="text"/>	<b>01~06</b>
<input type="text"/>	<input type="text"/>	<input type="text"/>	<input type="text"/>	<input type="text"/>	<input type="text"/>	<b>07~12</b>
<input type="text"/>	<input type="text"/>	<input type="text"/>	<input type="text"/>	<input type="text"/>	<input type="text"/>	<b>13~18</b>
<input type="text"/>	<input type="text"/>	<input type="text"/>	<input type="text"/>	<input type="text"/>	<input type="text"/>	<b>19~24</b>
<input type="text"/>	<input type="text"/>	<input type="text"/>	<input type="text"/>	<input type="text"/>	<input type="text"/>	<b>25~30</b>
<input type="text"/>	<input type="text"/>	<input type="text"/>	<input type="text"/>	<input type="text"/>	<input type="text"/>	<b>31~36</b>
<input type="text"/>	<input type="text"/>	<input type="text"/>	<input type="text"/>	<input type="text"/>	<input type="text"/>	<b>37~42</b>
<input type="text"/>	<input type="text"/>	<input type="text"/>	<input type="text"/>	<input type="text"/>	<input type="text"/>	<b>43~48</b>
<input type="text"/>	<input type="text"/>	<input type="text"/>	<input type="text"/>	<input type="text"/>	<input type="text"/>	<b>49~54</b>
<input type="text"/>	<input type="text"/>	<input type="text"/>	<input type="text"/>	<input type="text"/>	<input type="text"/>	<b>55~60</b>

**Default Values**

DSS No.	Key No.	Data Setting
1~4	01	TEL No. 01
	02	TEL No. 02
	48	TEL. No. 48
	49	Night Mode Switching
	50	Internal Paging Zone A (INT A)
	51	Internal Paging Zone B (INT B)
	52	Internal Paging Zone C (INT C)
	53	All Internal Paging Zone (INT ALL)
	54	Vacant
	55	Message Waiting (MSG)
	56	External Paging Zone A (EXT A)
	57	External Paging Zone B (EXT B)
	58	External Paging Zone C (EXT C)
	59	External Paging Zone All (EXT ALL)
	60	Transfer (TRF)

- Note:** Use the following to enter data:
- ⌂ to move the cursor left
  - # to move the cursor right
  - 0 (OPER) ~ 9 (WYS) to enter numeric data
  - Hold to set data when assigning Tel No. 01~96
  - Recall to go to the next page
  - Feature to go to the previous page

**4** Press **Transfer** to write the data.

**5** Press **Speaker** to go back on-line.



**Related Programming**

M.B. Number	Memory Block Name
1-6-00	Attendant Add-On Console to Telephone Port Assignment
7-2	Telephone Type Assignment

**N**

1. When TEL is assigned to a line key, the red LED is used to indicate Station Status.
2. When a function (e. g., Message or Paging) that does not require a green LED is assigned to a 2-colour LED key, the green LED does not function.
3. Telephone number setting data for telephone sets is determined by the number of installed ESI(8)-U( ) ETUs.
4. Message Waiting and Attendant Station Outgoing Lockout cannot be assigned on the same console.
5. DSS/CO keys should be programmed on line keys 1~48 only.
6. The Feature Access key with Live Record has seven features:

**Related Programming**

Feature No.	Feature
00	Record Start
01	Record Pause/Restart
02	Record Erase
03	Record Finish
04	Record Erase/Restart
05	Pager
06	Record Confirmation
07	Live Monitoring

7. Each function can be assigned by dialling the Feature No. using the dial pad after pressing LK1 on page 3.
8. Digital Voice Mail Mailbox Number can be entered using two, three, or four digits of the Mailbox number on the dial pad. This feature is used for Live Record addressing. The Live Record feature must be assigned to a line key on the console also.

# Attendant Transfer Selection During Live Record

*System Mode*  
**1**

*Submode*  
**6**

*Data No.*  
**08**

*PC Programming*  
 + **BTD**

## General Description

This Memory Block controls the behavior of the Attendant DSS/BLF transfer while the Attendant is engaged in a live recording operation. The call is either transferred to the DSS/BLF extension or the voice mail box of the DSS/BLF extension. If Yes is selected, the call is transferred to the DSS/BLF extension. If No is selected, the live record session is addressed to that DSS/BLF extension (no transfer).

## Display

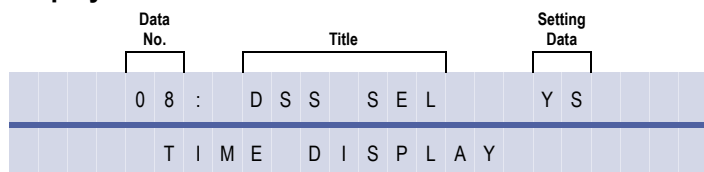





## Settings

LK 1	LK 2	LK 3	LK 4
No	Yes		
LK 5	LK 6	LK 7	LK 8

The shaded area indicates the default setting.

## Programming Procedures

- 1 Go off-line.
- 2 Press LK1 + LK6. Use  to move cursor to the second Data No. position and press  to access the Memory Block.
- 3 Press the corresponding CO/PBX line key to change the data option.
- 4 Press  to write the data.
- 5 Press  to go back on-line.

## Related Programming

No related programming is necessary for this Memory Block.

# Doorphone Assignment

## General Description

Use this Memory Block to enable the doorphones in System Programming.

## Display

Data No.	Title
00	DPH ASSIGN
	TIME DISPLAY

System Mode

1

Submode

7

Data No.

00

PC Programming

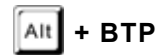

## Settings

LK 1	LK 2	LK 3	LK 4
DP1	DP2	DP3	DP4
LK 5	LK 6	LK 7	LK 8

There is no default setting.

## Programming Procedures

1	Go off-line.						
2	Press LK1 + LK7 +   to access the Memory Block.						
3	Press the CO/PBX line key corresponding to each doorphone. The LED changes to indicate the data each time the CO/PBX line key is pressed.						
	<table border="1"> <tbody> <tr> <td>CO/PBX Line LED</td> <td>Off</td> <td>On</td> </tr> <tr> <td>Data</td> <td>No</td> <td>Yes</td> </tr> </tbody> </table> <p>There is no default setting.</p>	CO/PBX Line LED	Off	On	Data	No	Yes
CO/PBX Line LED	Off	On					
Data	No	Yes					
4	Press  to write the data.						
5	Press  to go back on-line.						

## Related Programming

M.B. Number	Memory Block Name
1-7-01	Doorphone Display Time Selection

# Doorphone Display Time Selection

## General Description

Use this Memory Block to define how long a doorphone call signals a station before it times out.

With IPK R2000 and above, this memory block allows flexible entry.

*For R2000 only.*

## Display

Data No.	Title	Setting Data
01	DPH T I M E R	10 s
T I M E D I S P L A Y		





## Settings

LK 1	LK 2	LK 3	LK 4
10 sec.	30 sec.	60 sec.	90 sec.
LK 5	LK 6	LK 7	LK 8

The shaded area indicates the default setting.

*System Mode*  
**1**  
*Submode*  
**7**  
*Data No.*  
**01**  
*PC Programming*  
 + BTP

## Programming Procedures



1	Go off-line.
2	Press LK1 + LK7 +   to access the Memory Block.
3	Press the CO/PBX line key corresponding to each time assignment. The LED changes to indicate the data each time the CO/PBX line key is pressed.
4	Press  to write the data.
5	Press  to go back on-line.

*For R2000 and above.*



## Display

Data No.	Title	Setting Data
01	DPH T M R	10 s
T I M E D I S P L A Y		

## Programming Procedures

1	Go off-line.
2	Press LK1 + LK7 +   to access the Memory Block.

**Programming Procedures (Continued)**

<b>3</b>	Use the dial pad to enter the time required. <i>Note:</i> * to move cursor left. # to move cursor right. Setting Data (Allow): 01 to 99 sec	Default values: 10 secs
<b>4</b>	Press  to write the data.	
<b>5</b>	Press  to go back on-line.	

**Related Programming**

M.B. Number	Memory Block Name
<b>1-7-00</b>	Doorphone Assignment
<b>4-71</b>	Time Class Assignment for Telephone Mode (R2000 and above)

# External Speaker Connection Selection

## General Description

Use this Memory Block to specify whether or not external speakers are connected to the system.

## Display

Data No.	Title
02	ESP CONN
TIME DISPLAY	

System Mode  
**1**

Submode  
**7**

Data No.  
**02**



PC Programming  
 + BP

## Settings



LK 1	LK 2	LK 3	LK 4
ESP A	ESP B	ESP C	
LK 5	LK 6	LK 7	LK 8

The shaded area indicates the default setting.

## Programming Procedures

- Go off-line.
- Press LK1 + LK7 +   to access the Memory Block.
- Press the CO/PBX line key corresponding to each ESP Zone. The LED changes to indicate the data each time the CO/PBX line key is pressed.
 

CO/PBX Line LED	Off	On
Data	No	Yes

There is no default setting.
- Press  to write the data.
- Press  to go back on-line.

## Related Programming

M.B. Number	Memory Block Name
1-7-03	External Paging Alert Tone Selection



Only three external speaker zones can be connected to the system.

# External Paging Alert Tone Selection

## General Description

Use this Memory Block to specify whether or not a paging alert tone is sent on External Zone Paging (all speakers/individual speaker).

## Display

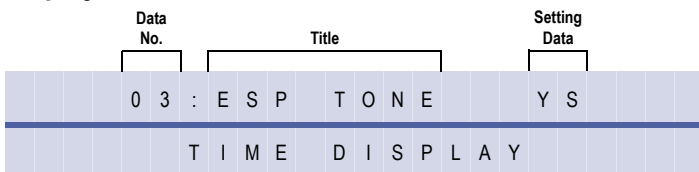

System Mode  
**1**

Submode  
**7**

Data No.  
**03**

PC Programming  
 + BP

## Settings

LK 1	LK 2	LK 3	LK 4
Yes	No		
LK 5	LK 6	LK 7	LK 8

The shaded area indicates the default setting.

## Programming Procedures

- 1 Go off-line.
- 2 Press LK1 + LK7 + to access the Memory Block.
- 3 Press the corresponding CO/PBX line key to change the data option.
- 4 Press to write the data.
- 5 Press to go back on-line.

## Related Programming

M.B. Number	Memory Block Name
<b>1-7-02</b>	External Speaker Connection Selection
<b>1-7-08</b>	External Speaker Chime Selection

# Doorphone Ringing Pattern Selection

## General Description

Use this Memory Block to define the doorphone ringing cycle. Each doorphone can be individually assigned.

## Display

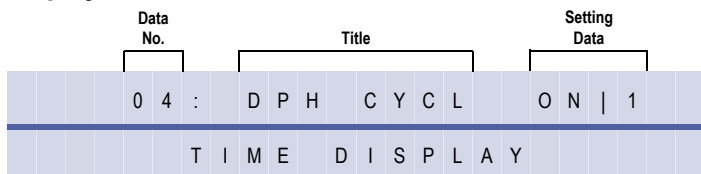

*System Mode*  
**1**  
*Submode*  
**7**  
*Data No.*  
**04**  
*PC Programming*  
 + BTP





## Settings

LK 1	LK 2	LK 3	LK 4
Off	On	Cycle A	Cycle B
LK 5	LK 6	LK 7	LK 8
Cycle C	Cycle D	Cycle E	Cycle F

The shaded area indicates the default setting.

LK 1	LK 2	LK 3	LK 4
Cycle G	Cycle H		
LK 5	LK 6	LK 7	LK 8

## Programming Procedures

1	Go off-line.	
2	Press LK1 + LK7 +   to access the Memory Block.	
3	Press the corresponding CO/PBX line key to change the data option.	<b>Default Values</b> All doorphones are LK2
4	Press  to write the data.	
5	Press  to go back on-line.	

## Related Programming

M.B. Number	Memory Block Name
1-7-00	Doorphone Assignment
1-7-05	Doorphone Ringing Frequency Selection
4-03	Doorphone Chime Assignment (Day Mode)
4-04	Doorphone Chime Assignment (Night Mode)





# Doorphone Ringing Frequency Selection

## General Description

Use this Memory Block to define the doorphone ringing frequency. Each doorphone can be individually assigned.

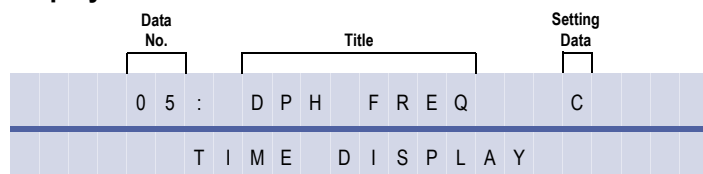
## Display







*System Mode*  
**1**  
*Submode*  
**7**  
*Data No.*  
**05**  
*PC Programming*  
 + BTP

## Settings

LK 1	LK 2	LK 3	LK 4
Freq A	Freq B	Freq C	Freq D
LK 5	LK 6	LK 7	LK 8
Freq E	Freq F	Freq G	Freq H

The shaded area indicates the default setting.

## Programming Procedures

<b>1</b>	Go off-line.
<b>2</b>	Press LK1 + LK7 +   to access the Memory Block.
<b>3</b>	Press the corresponding CO/PBX line key to change the data option.
<b>4</b>	Press  to write the data.
<b>5</b>	Press  to go back on-line.

## Related Programming

M.B. Number	Memory Block Name
<b>1-7-00</b>	Doorphone Assignment
<b>1-7-04</b>	Doorphone Ringing Pattern Selection

# External Paging Timeout Selection

*System Mode*  
**1**  
*Submode*  
**7**  
*Data No.*  
**06**  
*PC Programming*  
 + BP

## General Description

Use this Memory Block to specify the time allowed for External Paging before timeout and release of the paging circuit.

With IPK R2000 and above, this memory block allows flexible entry and four Classes.

*For R2000 only.*

## Display





Data No.	Title	Setting Data
06	ESP T I M E R	5 . 0
T I M E D I S P L A Y		

## Settings

LK 1	LK 2	LK 3	LK 4
0.5 min.	1.0 min.	1.5 min.	2.0 min.
LK 5	LK 6	LK 7	LK 8
3.0 min.	5.0 min.	8.0 min.	No Limit

The shaded area indicates the default setting.

## Programming Procedures



- 1 Go off-line.
- 2 Press LK1 + LK7 +   to access the Memory Block.
- 3 Press the corresponding CO/PBX line key to change the data option.
- 4 Press  to write the data.
- 5 Press  to go back on-line.

*For R2000 and above.*



## Display

Data No.	Title	Setting Data
06	ESP T M R X =	3 0 0 s
T I M E D I S P L A Y		

## Programming Procedures

- 1 Go off-line.
- 2 Press LK1 + LK7 +   to access the Memory Block.

**Programming Procedures (Continued)**

<b>3</b>	Use the dial pad to enter the time required. <i>Note:</i> * to move cursor left. # to move cursor right. Setting Data (Allow): Class 1 to Class 4: 000 to 999 sec <i>NOTE: CCIS Network use Class 1 only.</i>	Default values: Class 1 to Class 4 = 300 secs
<b>4</b>	Press  to write the data.	
<b>5</b>	Press  to go back on-line.	

**Related Programming**

M.B. Number	Memory Block Name
<b>1-2-00</b>	Internal Paging Timeout Selection
<b>1-7-02</b>	External Speaker Chime Selection
<b>4-71</b>	Time Class Assignment for Telephone Mode (R2000 and above)

# External Ring Relay Cycle Selection

## General Description

Use this Memory Block to assign one of six distinctive ringing controls/intervals to relay circuits.

## Display

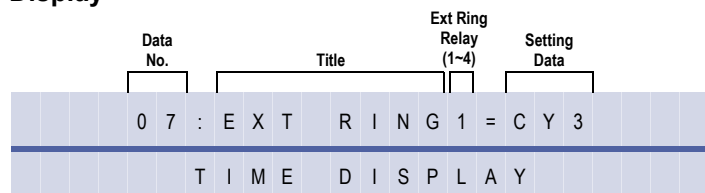





*System Mode*  
**1**  
*Submode*  
**7**  
*Data No.*  
**07**  
*PC Programming*  
 + BP

## Settings

LK 1	LK 2	LK 3	LK 4
Cycle 1	Cycle 2	Cycle 3	Cycle 4
LK 5	LK 6	LK 7	LK 8
Cycle 5	Cycle 6	Continuous	

The shaded area indicates the default setting.

## Programming Procedures

- 1 Go off-line.
- 2 Press L1 + LK7 +   to access the Memory Block.
- 3 Press corresponding CO/PBX line key to change the data option.
- 4 Press  to write the data.
- 5 Press  to go back on-line.

## Related Programming

M.B. Number	Memory Block Name
<b>1-2-00</b>	Internal Paging Timeout Selection
<b>1-7-02</b>	External Speaker Connection Selection
<b>2-08</b>	ECR Relay to Tenant Assignment
<b>4-71</b>	Time Class Assignment for Telephone Mode (R2000 and above)

# N

An External Tone relay or the Night Chime relay must be assigned in Memory Block 2-08 ECR Relay to Tenant Assignment before the tone is generated from JK1.

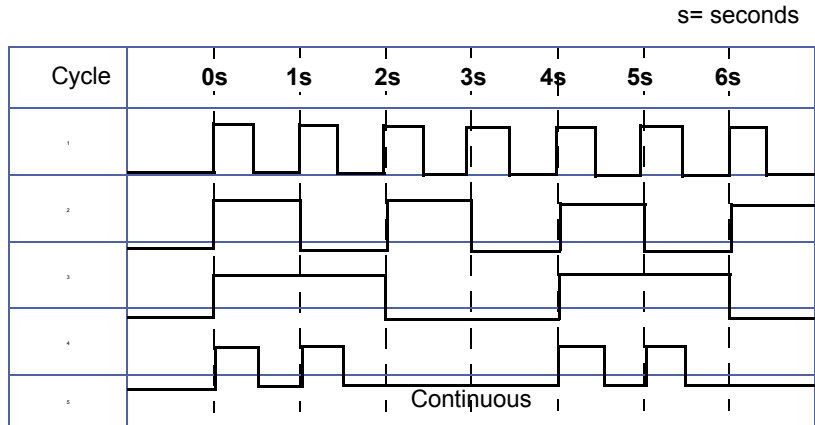



# External Speaker Chime Selection

## General Description

Use this Memory Block to determine whether paging alert tone (4 tones) or alert chime sounds before the speech path is established, or after, or before and after.

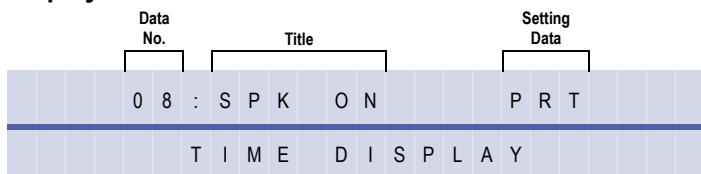
## Display



*System Mode*  
**1**  
*Submode*  
**7**  
*Data No.*  
**08**  
*PC Programming*  
 + BP





## Settings

LK 1	LK 2	LK 3	LK 4
PRT	C-S	C-B	
LK 5	LK 6	LK 7	LK 8

The shaded area indicates the default setting.

**PRT = Normal Paging Tone Before the Page**  
**C-S = Chime - Start Only (4 Tone Chime)**  
**C-B = Chime - Both Start and End (4 Tone Chime)**

## Programming Procedures

1	Go off-line.
2	Press LK1 + LK7 +   to access the Memory Block.
3	Press the corresponding CO/PBX line key to change the data option. LK - On = Enabled LK - Off = Disabled
4	Press  to write the data.
5	Press  to go back on-line.

## Related Programming

M.B. Number	Memory Block Name
1-7-03	External Paging Alert Tone Selection
1-7-09	External Speaker Chime Start Time Selection



Memory Block 1-7-03 External Paging Alert Tone Selection must be enabled before this Memory Block has any affect.

# External Speaker Chime Start Time Selection

System Mode  
**1**

Submode  
**7**

Data No.  
**09**

PC Programming  
 + BP

## General Description

This Memory Block is used only when paging alert tone (4-tones) is assigned in Memory Block 1-7-08 (External Speaker Chime Selection). This Memory Block assigns the delay after an external paging code is dialed and before the paging alert tone is provided.

## Display

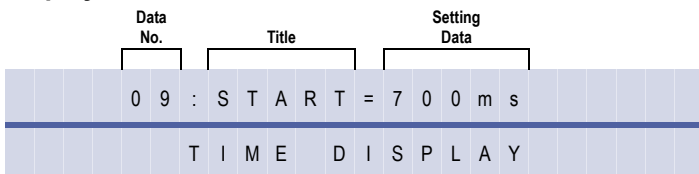

### (Page 1)







LK 1	LK 2	LK 3	LK 4
0 ms.	100 ms.	200 ms.	300 ms.
LK 5	LK 6	LK 7	LK 8
400 ms.	500 ms.	600 ms.	700 ms.

The shaded area indicates the default setting.

### (Page 2)

LK 1	LK 2	LK 3	LK 4
800 ms.	900 ms.	1000 ms.	1100 ms.
LK 5	LK 6	LK 7	LK 8
1200 ms.	1300 ms.	1400 ms.	1500 ms.

## Programming Procedures

<b>1</b>	Go off-line.
<b>2</b>	Press LK1 + LK7 +   to access the Memory Block.
<b>3</b>	Press the corresponding CO/PBX line key to change the data option. <b>Note:</b> Use the following when entering data:  to go to the next page  to go to the previous page
<b>4</b>	Press  to write the data and advance to Memory Block 1-8-01 SLT or Automated Attendant/DISA to PBR Selection.
<b>5</b>	Press  to go back on-line.

## Related Programming

M.B. Number	Memory Block Name
<b>1-7-08</b>	External Speaker Chime Selection

THIS PAGE INTENTIONALLY LEFT BLANK



# SLT or Automated Attendant/ DISA to PBR Selection

System Mode  
**1**

Submode  
**8**

Data No.  
**01**

PC Programming



## General Description

Use this Memory Block to specify whether the four Push Button Receiver (PBR) circuits in the CPU( )-U( ) ETU Unit are used for Single Line Telephones or the Automated Attendant/Direct Inward System Access (DISA).

## Display

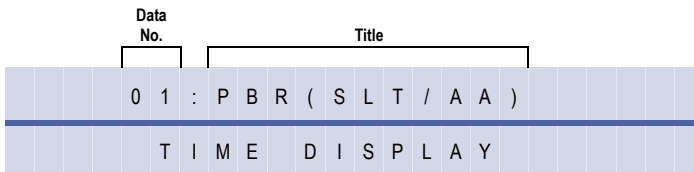

## Settings

LK 1	LK 2	LK 3	LK 4
PBR 1 and 2	PBR 3 and 4		
LK 5	LK 6	LK 7	LK 8

There is no default setting.

## Programming Procedures

- Go off-line.
- Press LK1 + LK8 + to access the Memory Block.
- Press the corresponding CO/PBX line key to change the data option.  
The LED indication changes to indicate the data each time the CO/PBX line key is pressed.
 

CO/PBX Line LED	Off	On
Data	Single Line Telephone	A.A./DISA

The shaded area indicates the default setting.
- Press to write the data.
- Press to go back on-line.

## Related Programming

No related programming is necessary for this Memory Block.

# N

- If LK1 and LK2 are assigned to Automated Attendant/DISA, the PBR( )-13 ETU must be installed in the system if Single Line Telephones are used.
- For Automated Attendant to function at least one PBR must be set.

# PBR Receive Level Assignment for Automated Attendant/DISA

System Mode  
**1**

Submode  
**8**

Data No.  
**02**

PC Programming  
 + AU





## General Description

Use this Memory Block to specify the receiving level of the Push Button Receiver (PBR) at the Automated Attendant/Direct Inward System Access (DISA).

## Display

Data No.	Title	PBR No. 1/2	Setting Data
02	PBR	1	= 13
T I M E D I S P L A Y			

## Programming Procedures

1	Go off-line.																																		
2	Press LK1 + LK8 +   to access the Memory Block.																																		
3	Use the dial pad to change the data option. The information that can be entered includes:	<p><b>Default Values (PBR 1 and 2)</b></p> <table border="1"> <thead> <tr> <th>Setting Data</th> <th>Receiving Level</th> </tr> </thead> <tbody> <tr> <td>05</td> <td>-46 dBm</td> </tr> </tbody> </table>	Setting Data	Receiving Level	05	-46 dBm																													
Setting Data	Receiving Level																																		
05	-46 dBm																																		
	<table border="1"> <thead> <tr> <th>Setting Data</th> <th>Receiving Level</th> </tr> </thead> <tbody> <tr><td>00</td><td>-33.0 dBm</td></tr> <tr><td>01</td><td>-34.0 dBm</td></tr> <tr><td>02</td><td>-35.0 dBm</td></tr> <tr><td>03</td><td>-36.0 dBm</td></tr> <tr><td>04</td><td>-37.0 dBm</td></tr> <tr><td>05</td><td>-38.0 dBm</td></tr> <tr><td>06</td><td>-39.0 dBm</td></tr> <tr><td>07</td><td>-40.0 dBm</td></tr> <tr><td>08</td><td>-41.0 dBm</td></tr> <tr><td>09</td><td>-42.0 dBm</td></tr> <tr><td>10</td><td>-43.0 dBm</td></tr> <tr><td>11</td><td>-44.0 dBm</td></tr> <tr><td>12</td><td>-45.0 dBm</td></tr> <tr><td>13</td><td>-46.0 dBm</td></tr> <tr><td>14</td><td>-47.0 dBm</td></tr> <tr><td>15</td><td>-48.0 dBm</td></tr> </tbody> </table>	Setting Data	Receiving Level	00	-33.0 dBm	01	-34.0 dBm	02	-35.0 dBm	03	-36.0 dBm	04	-37.0 dBm	05	-38.0 dBm	06	-39.0 dBm	07	-40.0 dBm	08	-41.0 dBm	09	-42.0 dBm	10	-43.0 dBm	11	-44.0 dBm	12	-45.0 dBm	13	-46.0 dBm	14	-47.0 dBm	15	-48.0 dBm
Setting Data	Receiving Level																																		
00	-33.0 dBm																																		
01	-34.0 dBm																																		
02	-35.0 dBm																																		
03	-36.0 dBm																																		
04	-37.0 dBm																																		
05	-38.0 dBm																																		
06	-39.0 dBm																																		
07	-40.0 dBm																																		
08	-41.0 dBm																																		
09	-42.0 dBm																																		
10	-43.0 dBm																																		
11	-44.0 dBm																																		
12	-45.0 dBm																																		
13	-46.0 dBm																																		
14	-47.0 dBm																																		
15	-48.0 dBm																																		
4	Press  to write the data and advance to the next PBR.																																		
5	Enter next PBR, and press  to write data.																																		
6	Press  to go back on-line.																																		

## Related Programming

No related programming is necessary for this Memory Block.



- When the Automated Attendant answers, the DTMF signal level from the calling party is reduced from the Public Switching Telephone Network (PSTN). This Memory Block specifies the minimum detectable receiving level. Setting Data 15 is the most sensitive.
- PBR 1 data is for Channels 1 and 2 and PBR 2 is for Channels 3 and 4 in the CPU( )-U( ) ETU/MBD-U( ) Unit.

# Time Display (12h/24h) Selection

## General Description

Use this Memory Block to specify either a 12-hour (12:00 a.m. to 11:59 p.m.) or 24-hour (00:00 to 23:59) time display.

## Display

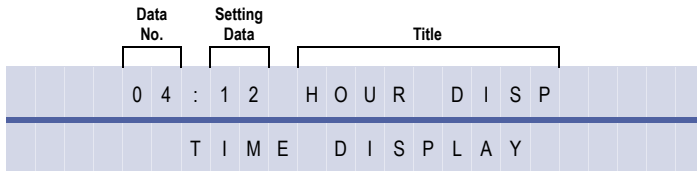





*System Mode*  
**1**  
*Submode*  
**8**  
*Data No.*  
**04**  
*PC Programming*  
 + **BM**

## Settings

LK 1	LK 2	LK 3	LK 4
12 Hr	24 Hr		
LK 5	LK 6	LK 7	LK 8

The shaded area indicates the default setting.

## Programming Procedures

- 1 Go off-line.
- 2 Press LK1 + LK8 +   to access the Memory Block.
- 3 Press corresponding CO/PBX line key to change the data option.
- 4 Press  to write the data.
- 5 Press  to go back on-line.

## Related Programming

No related programming is necessary for this Memory Block.

# Class of Service (Attendant) Feature Selection 1

System Mode  
**1**

Submode  
**8**

Data No.  
**07**

PC Programming  
 + **BTS**

## General Description

Use this Memory Block to allow or deny specific attendant features for each Class Of Service. When individual stations are assigned, the station user can access only the features designated allow.

## Display

Data No.	Title	Class No. (00-15)	Page No. (01-03)
07	CLS1	(00)	01
TIME DISPLAY			

## Settings

### (Page 1)

LK 1	LK 2	LK 3	LK 4
Night Mode Switching	Night Mode Switching Per Tenant	System Speed Dial Programming	Not Used
LK 5	LK 6	LK 7	LK 8
Not Used	Not Used	Automatic Trunk-to-Trunk Transfer Set/Reset	Automated Attendant/DISA Set/Reset Mode

### (Page 2)



LK 1	LK 2	LK 3	LK 4
Timed Alarm for Single Line Telephone Set/Reset	Call Forward Set/Cancel from Destination Station	System-Wide Reset Refer to Note 1	Password (Outgoing Restriction) Refer to Note 2
LK 5	LK 6	LK 7	LK 8
DISA Password Cancel	DISA Password Confirmation	Weekend Mode Per Tenant	Forced Account Code

There is no default setting.

### (Page 3)

LK 1	LK 2	LK 3	LK 4
Terminal Exchange Mode Set	Not Used	Not Used	Not Used
LK 5	LK 6	LK 7	LK 8
Not Used	Not Used	Not Used	Not Used

## Programming Procedures

<b>1</b>	Go off-line.
<b>2</b>	Press LK1 + LK8 +   to access the Memory Block.



**Programming Procedures** (Continued)



- 3 Press the corresponding CO/PBX line key to enter data.  
The LED indication changes to indicate the data each time a CO/PBX line key is pressed.

CO/PBX Line Key LED	Off	On
Data	Deny	Allow

Refer to Table on following page for default settings.

**Note:** Use the following when entering data:

- Press  to go to the next page
- Press  to go to the previous page

- 4 Press  key. Data for Class 01 ~ 15 is displayed successively.
- 5 Press  to write the data for Class 15.
- 6 Press  to go back on-line.

**Related Programming**

M.B. Number	Memory Block Name
4-17	Station to Class of Service Feature Assignment

**N**

1. System-Wide Reset selection resets the following: Timed Alarm, Call Forward-All Call, Do Not Disturb, Customised Message, and Callback Request.
2. Password (Outgoing Restriction) selection cancels Station Lockout and default password for another station.
3. Sixteen Classes (00 ~ 15) of feature restriction patterns allow a station user to activate particular features while restricting others.
4. At default, stations 100 and 101 are in class 00. All other stations are in class 15.
5. Stations are assigned to a Class of Service in Memory Block 4-17 Station to Class of Service Feature Assignment.
6. If Terminal Exchange Mode is enabled by user on Attendant Station the PC Programming is unavailable.
7. Terminal Exchange Mode must be set to OFF on the extension to enable PC connection to function.

Classes 00 ~ 15 are programmed in this Memory Block as feature restriction classes. In Memory Block 4-17 Station to Class of Service Feature Assignment specify any class of service for each telephone to assign the features the user can/cannot activate.

Corresponding CO/PBX Line Key	Function Name	Default Class 00	Default Class 01 ~ 15
<b>Page 01</b>			
LK1	Night Mode Switching (System-Wide))	Allow	Deny
LK2	Night Mode Switching (Tenant)	Allow	Deny
LK3	System Speed Dial Programming	Allow	Deny
LK4	Not Used	N/A	N/A
LK5	Not Used	N/A	N/A
LK6	Not Used	N/A	N/A
LK7	Automatic Trunk-to-Trunk Transfer (Set/Reset) and programming of Outgoing Numbers	Allow	Deny
LK8	Automated Attendant/DISA Mode (Set/Reset)	Allow	Deny
<b>Page 02</b>			
LK1	Timed Alarm (Set/Reset) for Single Line Telephones	Allow	Deny
LK2	–Call Forward-All Call (Set/Reset) from Destination Station –Call Forward CAR Keys –Call Forward All Call Set –Call Forward Busy/No Answer set	Allow	Deny
LK3	System-Wide Reset of Timed Alarm, Call Forward-All Calls, Do Not Disturb, Customised Message, and Callback Request	Deny	Deny
LK4	Cancel Station Lockout and Default Password for another Station	Allow	Deny
LK5	DISA Password Cancel	Allow	Deny
LK6	DISA Password Confirmation	Allow	Deny
LK7	Automated Attendant Weekend Mode (Set/Reset) Tenant	Allow	Deny
LK8	Forced Account Code Programming	Allow	Deny
<b>Page 03</b>			
LK1	Terminal Exchange Mode Set	Allow	Deny
LK2-LK8	Not Used	N/A	N/A

# Class of Service (Station) Feature Selection 2

System Mode  
**1**

Submode  
**8**

Data No.  
**08**

PC Programming



## General Description

Use this Memory Block to allow or deny specific station features for each Class of Service. When individual stations are assigned, the station user can access only the features designated allow.

## Display

Data No.	Title	Class No. (00-15)	Page No. (01-03)
08	CLS2	(00)	01
T I M E D I S P L A Y			

## Settings

### (Page 1)

LK 1	LK 2	LK 3	LK 4
Call Forward-All Calls, DND, Break Mode	Trunk Queuing	Automatic Callback	Barge-In (Calling Party)
LK 5	LK 6	LK 7	LK 8
Rejection of Barge-In (Called Party)	Timed Alarm for SLT	General Purpose Relay	Voice / Tone Override

### (Page 2)

LK 1	LK 2	LK 3	LK 4
Absence Message	Callback Message	Station Outgoing Lockout Set	Not Used
LK 5	LK 6	LK 7	LK 8
Call Forward Busy/No Answer Set	VRS Voice Message	Disable 10 sec. Code Restriction Timer	DISA Password Code Restriction Password Override

### (Page 3)

LK 1	LK 2	LK 3	LK 4
Not Used	User Ringing Line Preference Set/Reset	Voice/Tone Override (Receive)	LCR/ACR Bypass
LK 5	LK 6	LK 7	LK 8
Station Trunk-to-Trunk Transfer	Account Code Entry	Digit Restriction Timer Selection	Call Alert Notification

### (Page 4)

LK 1	LK 2	LK 3	LK 4
LCR/ACR Recall	DSS Key Transfer Operation	Caller ID	Caller ID Number Selection
LK 5	LK 6	LK 7	LK 8
Manual Live Record Activate	Auto Live Record Activate	BGM	Unsupervised Conference

### (Page 5)

LK 1	LK 2	LK 3	LK 4
Forced Account Code	Group Listening Selection	Station Relocation	Set Call Forward-Off Premise
LK 5	LK 6	LK 7	LK 8
Pre-Set Dialling	Live Monitoring	2 Row Caller ID Display	Malicious Call Trace







### (Page 6)

LK 1	LK 2	LK 3	LK 4
ACR Normal Originate	VM MSG LED	Forced Account Code VERIFY/UNVERIFY	ISDN Supplementary Services
LK 5	LK 6	LK 7	LK 8
CCIS Caller ID	Call Monitor Originate	Call Monitor Receive	Save Caller ID Missed Call

### (Page 7)

LK 1	LK 2	LK 3	LK 4
Send Caller ID to SLT	Not Used	Not Used	Not Used
LK 5	LK 6	LK 7	LK 8
Not Used	Not Used	Not Used	Not Used

**Programming Procedures**

<b>1</b>	Go off-line.9						
<b>2</b>	Press LK1 + LK8 +   to access the Memory Block.						
<b>3</b>	<p>Press the corresponding CO/PBX line key to change the data option. The LED indication changes to indicate data each time CO/PBX line key is pressed.</p> <table border="1" style="margin-left: 20px;"> <thead> <tr> <th style="text-align: center;">CO/PBX Line Key LED</th> <th style="text-align: center;">Off</th> <th style="text-align: center;">On</th> </tr> </thead> <tbody> <tr> <td style="text-align: center;">Data</td> <td style="text-align: center;">Deny</td> <td style="text-align: center;">Allow</td> </tr> </tbody> </table> <p style="margin-left: 20px;">Refer to Table on following page for default settings.</p> <p><b>Note:</b> Press  to go to the next page. Press  to go back to the previous page.</p>	CO/PBX Line Key LED	Off	On	Data	Deny	Allow
CO/PBX Line Key LED	Off	On					
Data	Deny	Allow					
<b>4</b>	Press  key. Data for Class 01 ~ 15 is displayed successively						
<b>5</b>	Press  to write the data for class 15.						
<b>6</b>	Press  to go back on-line.						

**Related Programming**

M.B. Number	Memory Block Name
4-17	Station to Class of Service Feature Assignment

**N**

1. Sixteen Classes (00~15) of feature restriction patterns allow a station user to activate particular features while restricting others.
2. At default, all stations are in Class 00.
3. Stations are assigned to a Class of Service in Memory Block 4-17 Station to Class of Service Feature Assignment.
4. LCR/ARS Bypass (Page 3, LK 4) applies only when the station is assigned to an LCR/ARS Class (1~4) in Memory Block 4-40 (LCR Class Selection). LCR/ARS Bypass does not apply when using access codes to directly access an ARS Table (functions 601~604 – ARS Tables 1~4) in Memory Blocks 1-1-46~48 [Access Code (1/2/3-Digit) Assignment].
5. ARS Overflow (Page 6, LK 1) allows or restricts access to Trunk Group 01 when the first priority trunk group (programmed route) is busy.

Corresponding CO/PBX Line Key	Function Name	Default Class 00	Default Class 01 ~ 15
<b>Page 01</b>			
LK1	Set Call Forward - All Call, Do Not Disturb (DND), Break Mode	Allow	Deny
LK2	Trunk Queuing	Allow	Deny
LK3	Automatic Callback	Allow	Deny
LK4	Barge-In Originate on a CO/PBX Line	Deny	Deny
LK5	Barge-In Receive	Allow	Deny
LK6	Timed Alarm (Set/Cancel)	Allow	Deny

Doc. No.: 8194 - Release 2.0  
December 2004



Corresponding CO/PBX Line Key	Function Name	Default Class 00	Default Class 01 ~ 15
LK7	General Purpose Relay	Allow	Deny
LK8	Voice Override/Tone Override Originate	Allow	Deny
<b>Page 02</b>			
LK1	Absence Message	Allow	Deny
LK2	Callback Request Originate	Allow	Deny
LK3	Station Outgoing Lockout (Set/Cancel)	Allow	Deny
LK4	Not Used	N/A	N/A
LK5	Call Forward Busy, No Answer, Busy/No Answer Set	Allow	Deny
LK6	VRS Voice Message Record/Verify/Erase	Allow	Deny
LK7	Not Used	N/A	N/A
LK8	DISA PAssword Set/Code Restriction Password Override	Allow	Deny
<b>Page 03</b>			
LK1	Not Used	N/A	N/A
LK2	User Ringing Line Preference Set/Reset	Allow	Deny
LK3	Voice Override/Tone Override/Camp-On Receive	Allow	Deny
LK4	LCR Bypass (Trunk Groups 02 ~ 32)	Deny	Deny
LK5	Station Trunk-to-Trunk Transfer	Deny	Deny
LK6	Account Code Entry	Deny	Deny
LK7	Digit Restriction Timer Selection	Allow	Allow
LK8	Call Alert Notification for DIT, DID, and A.P.	Allow	Deny

Corresponding CO/PBX Line Key	Function Name	Default Class 00	Default Class 01 ~ 15
<b>Page 04</b>			
LK1	LCR Recall	Allow	Deny
LK2	DSS Key Transfer Operation Operation applies to Feature Access/One-Touch keys and Attendant Add-On console keys programmed for DSS. After you press a DSS key and go on-hook, only an Allow Call is transferred.	Deny	Deny
LK3	Caller ID	Deny	Deny
LK4 (Future Network Release is dependant on Carrier Network)	Caller ID Number Selection If set for deny, Name is displayed if both name and number are received. If set for allow, Number is displayed if both name and number are received.	Deny	Deny
LK5	Manual Live Record Activate	Deny	Deny
LK6	Auto Live Record Activate. LK5 must be on also.	Deny	Deny
LK7	BGM Selection	Allow	Deny
LK8	Unsupervised Conference	Deny	Deny
<b>Page 05</b>			
LK1	Forced Account Code	Deny	Deny
LK2	Group Listening Selection	Deny	Deny
LK3	Station Relocation	Allow	Deny
LK4	Set Call Forward-Off Premise Related to Page 01(LK1) and Page 02 (LK5)	Deny	Deny
LK5	Pre-Set Dialling	Deny	Deny
LK6	Live Monitoring	Deny	Deny
LK7	2-Row Caller ID Display	Deny	Deny
LK8	Malicious Call Trace	Deny	Deny

Corresponding CO/PBX Line Key	Function Name	Default Class 00	Default Class 01 ~ 15
<b>Page 06</b>			
LK1	ACR Normal Originate	Deny	Deny
LK2	VM MSG Key To turn on/off display of new message sent to a Voice Mail Box.	Deny	Deny
LK3	Forced Account Code - VERIFY/UNVERIFY	Deny	Deny
LK4	ISDN Supplementary Services	Deny	Deny
LK5	Not used		
LK6	Not used		
LK7	Not used		
LK8	Not used		

**N**

Setting Page 04 - LK4 to ON will affect the "Speed Dial" Name match feature, therefore this setting is required to be set to OFF at all times.

# Music on Hold Pattern Selection

## General Description

Use this Memory Block to specify the Music on Hold pattern.

## Display

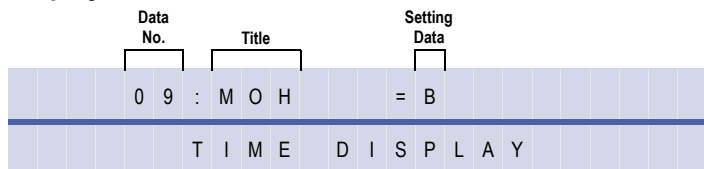

*System Mode*  
**1**  
*Submode*  
**8**  
*Data No.*  
**09**  
*PC Programming*

## Settings

LK 1	LK 2	LK 3	LK 4
A	B		
LK 5	LK 6	LK 7	LK 8

The shaded area indicates the default setting.

Medley A = American Folk Song Medley

Medley B = Christmas Song Medley

## Programming Procedures

- 1 Go off-line.
- 2 Press LK1 + LK8 + to access the Memory Block.
- 3 Press the corresponding CO/PBX line key to change the data option.
- 4 Press to write the data.
- 5 Press to go back on-line.

## Related Programming

M.B. Number	Memory Block Name
1-8-31	Hold Tone Source Selection
1-8-32	Hold Internal Tone Volume Selection



1. Music on Hold can be provided to CO/PBX and intercom calls that are placed on hold.
2. One of two melodies can be selected:
  - A = American Folk Song Medley
  - B = Christmas Song Medley

# PBR Interdigit Release Timer Selection

## General Description

Use this Memory Block to specify the interdigit release time for the Push Button Receiver (PBR).

## Display

Data No.	Title	Setting Data
10	PBR RELEASE	7 s
TIME DISPLAY		

System Mode  
**1**

Submode  
**8**

Data No.  
**10**





PC Programming  
 + **BM**

## Settings

LK 1	LK 2	LK 3	LK 4
3 sec.	4 sec.	5 sec.	6 sec.
LK 5	LK 6	LK 7	LK 8
7 sec.	8 sec.	9 sec.	10 sec.

The shaded area indicates the default setting.

## Programming Procedures

- 1 Go off-line.
- 2 Press LK1 + LK8 +   to access the Memory Block.
- 3 Press the corresponding CO/PBX line key to change the data option.
- 4 Press  to write the data.
- 5 Press  to go back on-line.

## Related Programming

M.B. Number	Memory Block Name
1-3-03	First Digit PBR Release Timer Selection
1-8-01	SLT or Automated Attendant/DISA to PBR Selection

**N**

A DTMF Single Line Telephone connected to the Xen system must be supported by a PBR that receives DTMF signals.

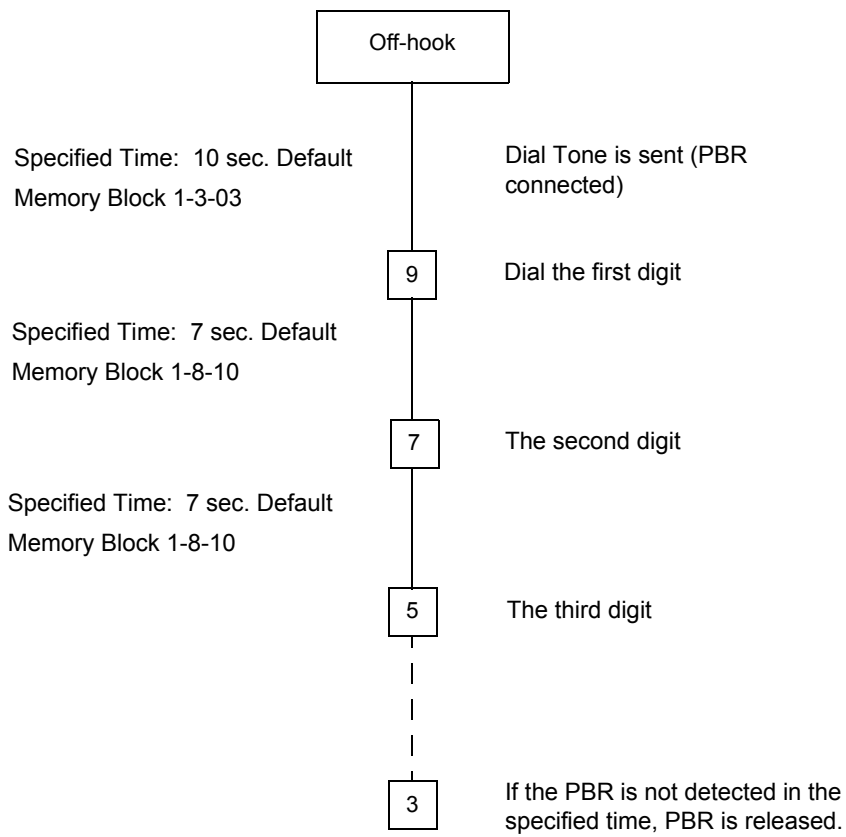

# System Refresh Timer Assignment

System Mode  
**1**

Submode  
**8**

Data No.  
**11**

PC Programming



## General Description

Use this Memory Block to assign the System Refresh Time during idle periods/no change in state.

## Display

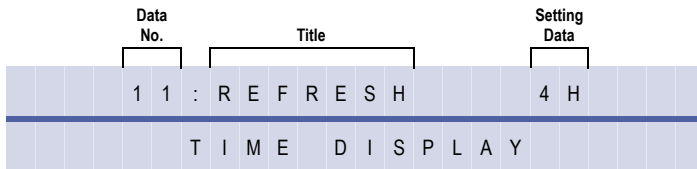

## Settings

LK 1	LK 2	LK 3	LK 4
No Refresh	4 hr.	8 hr.	12 hr.
LK 5	LK 6	LK 7	LK 8
24 hr.			

The shaded area indicates the default setting.

## Programming Procedures

1	Go off-line.
2	Press LK1 + LK8 +   to access the Memory Block.
3	Press the corresponding CO/PBX line key to change the data option.
4	Press  to write the data.
5	Press  to go back on-line.

## Related Programming

No related programming is necessary for this Memory Block.



1. The system automatically refreshes itself during idle periods based on the time specified in this Memory Block.
2. If there is a call in progress during Refresh Time activity and no other actions occurring in the system at that time, the system will refresh.

# VRS Message Recording Time Selection

System Mode  
**1**

Submode  
**8**

Data No.  
**12**

PC Programming  
 + AR

## General Description

Use this Memory Block to specify the length and number of messages for each of the eight Voice Recording Service (VRS) channels.

## Display

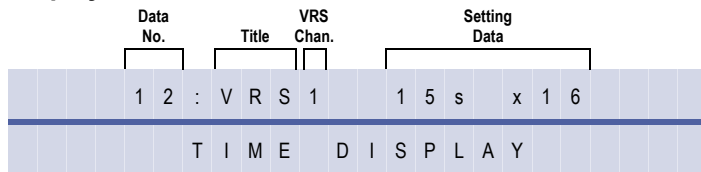







## Settings

LK 1	LK 2	LK 3	LK 4
Recording Time 15 sec. 16 messages	Recording Time 30 sec. 8 messages	Recording Time 60 sec. 4 messages	Recording Time 120 sec. 2 messages
LK 5	LK 6	LK 7	LK 8

The shaded area indicates the default setting.

## Programming Procedures

1	Go off-line.	
2	Press LK1 + LK8 +   to access the Memory Block.	
3	Press corresponding CO/PBX line key to change data option. <b>Note:</b> Use the following to enter VRS Channel:  ~  to enter numeric data	<b>Default Values</b> All VRS Channels Recording Time = 15 seconds, 16 messages
4	Press  to write the data and advance to the next VRS Channel.	
5	After entering last data, press  to write the data.	
6	Press  to go back on-line.	

## Related Programming

No related programming is necessary for this Memory Block.



Voice Recording Services Channel 1 has 240 seconds for message recording. The number of messages that can be recorded depends on message length. Divide 240 by the message length to obtain number.



# VRS Message Function Assignment

System Mode  
**1**

Submode  
**8**

Data No.  
**13**

PC Programming



## General Description

Use this Memory Block to assign the recorded voice prompt Delay Announcement/ Automated Attendant Message to the Voice Recording Service (VRS) channel. Refer to Memory Block 1-8-12 (VRS Message Recording Time Selection), for the quantity of messages per channel allowed.

## Display

Data No.	Title	VRS Channel No. (1~8)	Message Location No. (1~16)	Setting Data	Page No.
13	VRS	1	01	NON	1
T I M E D I S P L A Y					

## Settings

### (Page 1)

LK 1	LK 2	LK 3	LK 4	LK5	LK6	LK7	LK8
NON	V1 (Voice Prompt)	V2 (Voice Prompt)	M1 (Delay Message)	Not Used	Not Used	Not Used	Not Used

### (Page 2)

LK 1	LK 2	LK 3	LK 4	LK5	LK6	LK7	LK8
D1 (Day A A)	D2 (Day A A)	D3 (Day A A)	D4 (Day A A)	D5 (Day A A)	D6 (Day A A)	D7 (Day A A)	D8 (Day A A)

The shaded selection is the default.

### (Page 3)

LK 1	LK 2	LK 3	LK 4	LK5	LK6	LK7	LK8
N1 (Night A A)	N2 (Night A A)	N3 (Night A A)	N4 (Night A A)	N5 (Night A A)	N6 (Night A A)	N7 (Night A A)	N8 (Night A A)

### (Page 4)

LK 1	LK 2	LK 3	LK 4	LK5	LK6	LK7	LK8
W1 (Weekend A A)	W2 (Weekend A A)	W3 (Weekend A A)	W4 (Weekend A A)	W5 (Weekend A A)	W6 (Weekend A A)	W7 (Weekend A A)	W8 (Weekend A A)

## N

- The amount of messages per channel that can be assigned is dependant on MB 1-8-12 (VRS Message Time Selection). Message Location number will not change in MB 1-8-12 to reflect the setting in MB 1-8-12, but the amount of messages that the system software will allow to be recorded is in accordance to MB 1-8-12.
- VRS card channel 1~4 is assigned as "VRS = 01" in MB 7-01.  
VRS card channel 5~8 is assigned as "VRS = 05" in MB 7-01.
- A hardware upload of two (2) VRS cards will change their positions, if VRS channels 5~8 are assigned before VRS channels 1~4 in MB 7-01.

# Tone Assignment

## General Description

Use this Memory Block to assign each system tone to the flexible tables.

## Display

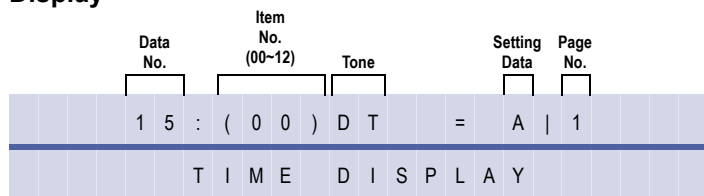

System Mode  
**1**

Submode  
**8**

Data No.  
**15**

PC Programming  
 + **BI**

## Settings

### (Page 1)







LK 1	LK 2	LK 3	LK 4
Tone A	Tone B	Tone C	Tone D
LK 5	LK 6	LK 7	LK 8
Tone E	Tone F	Tone G	Tone H

### (Page 2)

LK 1	LK 2	LK 3	LK 4
Tone I	Tone J	Tone K	Tone L
LK 5	LK 6	LK 7	LK 8
Tone M			

The shaded area indicates the default setting.

## Programming Procedures

- 1 Go off-line.
- 2 Press LK1 + LK8 +   to access the Memory Block.
- 3 Press the corresponding CO/PBX line key to change the Setting Data option.  
Use  ~  to enter Table No.
- 4 Press  to write the data and advance to the next table.
- 5 After entering last data, press  to write the data.
- 6 Press  to go back on-line.







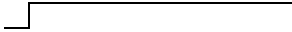

## Related Programming

No related programming is necessary for this Memory Block.

**Default Table**

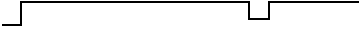
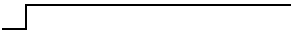
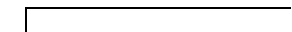
Table Number	Tone	LCD	Default
00	ICM Dial Tone	DT	A
01	Second Dial Tone	2DT	B
02	Special Dial Tone	SPDT	C
03	Busy Tone	BT	D
04	Reorder/Error Tone	ROT	E
05	Howler Tone	HWT	F
06	Service Set Tone	SST	G
07	ICM Ringback Tone	RBT1	I
08	Tie/DID Ringback Tone	RBT2	I
09	Call Waiting Tone	CWT	J
10	LCR Dial Tone	SDT	K
11	Tone Burst 1	TB1	G
12	Tone Burst 2	TB2	K

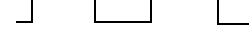
**Tone Table**

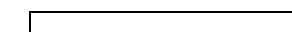
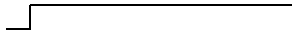
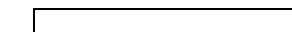
<b>Tone</b>	<b>Frequency (Hz)</b>	<b>Intermittent</b>	<b>Cycle</b>
<b>A</b>	350/440	Continuous	
<b>B</b>	440	120 IPM 0.25 On, 0.25 Off 0.25 On, 1.25 Off	
<b>C</b>	440	240 IPM 0.125 On, 0.125 Off	
<b>D</b>	425	80 IPM 0.375 On, 0.375 Off	
<b>E</b>	425	2.5 On, 0.5 Off	
<b>F</b>	2400 16 Hz Mod.	Continuous	
<b>G</b>	800	Continuous	
<b>H</b>	400	0.075 On, 0.1 Off 0.075 On, 0.1 Off 0.075 On, 0.1 Off 0.075 On, 0.4 Off	
<b>I</b>	425 25 Hz Mod.	0.4 On, 0.2 Off	
<b>J</b>	440 20 Hz Mod.	60 IPM 0.5 On, 0.5 Off	
<b>K</b>	400	Continuous	
<b>L</b>	400	60 IPM 0.5 On, 0.50 Off	
<b>M</b>	No Tone	Continuous	

# Voice Prompt to Tone Assignment

## General Description

Use this Memory Block to assign the voice prompt to each tone. Voice prompt is provided only during the Internal Dial tone or Call Waiting tone.

## Display

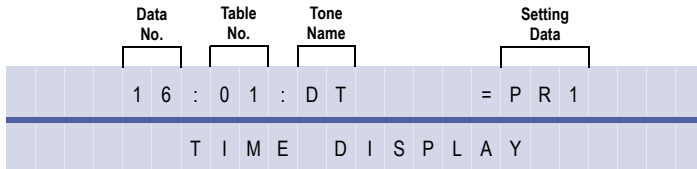

System Mode  
**1**

Submode  
**8**

Data No.  
**16**





PC Programming  
 + AR

## Settings

LK 1	LK 2	LK 3	LK 4
Voice Prompt 1	Voice Prompt 2		
LK 5	LK 6	LK 7	LK 8

The shaded area indicates the default setting.

## Programming Procedures

<b>1</b>	Go off-line.	
<b>2</b>	Press LK1 + LK8 +   to access the Memory Block.	
<b>3</b>	Press corresponding CO/PBX line key to change data option. <b>Note:</b> Table No. 1: Dial tone Table No. 2: Call Waiting tone	<b>Default Values</b> Dial Tone: Voice Prompt 1 Call Waiting Tone: Voice Prompt 2
<b>4</b>	Press  to write the data and advance to Table 02.	
<b>5</b>	After entering last data, press  to write the data.	
<b>6</b>	Press  to go back on-line.	

## Related Programming

M.B. Number	Memory Block Name
	Refer to <i>Chapter 2 Guide to Feature Programming</i> .

# PC Programming Password Assignment

## General Description

Use this Memory Block to assign system passwords that must be entered when connecting to the system using MAT PC Programming.

## Display

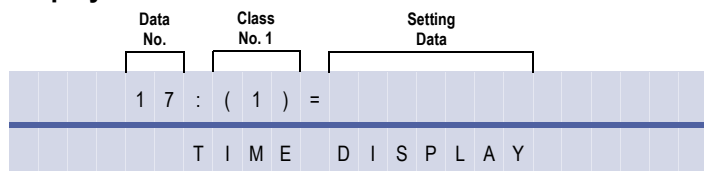

*System Mode*  
**1**

*Submode*  
**8**

*Data No.*  
**17**

*PC Programming*  
 + **CSP**

## Programming Procedures

<b>1</b>	Go off-line.	
<b>2</b>	Press LK1 + LK8 +   to access the Memory Block.	
<b>3</b>	Use the following to enter Class 1 (Technician Mode) and password (8 digits max). <b>Note:</b> Use the following to enter data: ~  to enter numeric data Press  to clear data	<b>Default Values</b> Class 1, 2 All Blank
<b>4</b>	Press  to write the data and advance to Class 2 (End User Mode).	
<b>5</b>	After entering Class 2 password, press  to write the data. The next Memory Block is displayed.	
<b>6</b>	Program the next Memory Block or press  to go back on-line.	

## Related Programming

No related programming is necessary for this Memory Block.

# N

1. Password 1 (Class 1) is used for Technician MAT PC Programming
2. Password 2 (Class 2) is used for End User MAT PC Programming.
3. Password 1 (Class 1) can be assigned only by telephone programming. It cannot be assigned or changed by Technician or End User MAT PC Programming.
4. Password 2 (Class 2) can be assigned by telephone programming or Technician MAT PC Programming. It cannot be assigned or changed by End User MAT PC Programming.
5. Password 2 (Class 2) cannot be assigned until password 1 (Class 1) is assigned in the Memory Block.
6. For passwords for both classes; only the first 5 digits are used.

# Site Name Assignment

## General Description



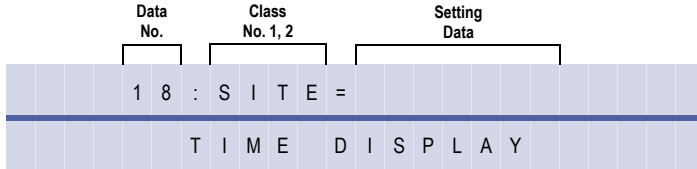

Use this Memory Block to indicate a system name for PC Programming software to use to program the system.

## Display



*System Mode*  
**1**  
*Submode*  
**8**  
*Data No.*  
**18**  
*PC Programming*  
 + CSN

## Programming Procedures

1	Go off-line.
2	Press LK1 + LK8 +   to access the Memory Block.
3	Use Character Code Table in Section 7, and enter up to eight characters for Setting Data. <b>Note:</b> Press  to clear data at cursor
4	Press  to write the data.
5	Press  to go back on-line.

## Related Programming

No related programming is necessary for this Memory Block.

# N

When programmed, this assignment creates a directory in the PC after download is performed

# ACD/UCD Group Agent Assignment

System Mode  
**1**

Submode  
**8**

Data No.  
**25**

PC Programming  
 + AA



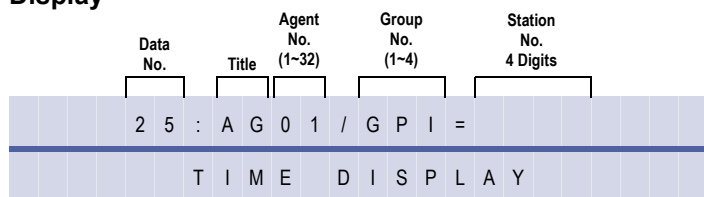

## General Description

Use this Memory Block to specify the Agent Extension Number and the Automatic Call Distribution/Uniform Call Distribution (ACD/UCD) Group Numbers where each agent is assigned.

## Display



## Programming Procedures

1	Go off-line.
2	Press LK1 + LK8 +   to access the Memory Block.
3	Setting data includes Group no. (1 ~ 4) and Station No. (4 digits max.) Use dial pad to enter data. <span style="float: right;"><b>Default Values</b> Not Specified</span> Agent station number is one of the following: <ul style="list-style-type: none"> <li>• 2 digit (00 ~ 99)</li> <li>• 3 digit (000 ~ 999)</li> <li>• 4 digit (0000 ~ 9999)</li> </ul>
4	Press  to write Group and Station No. and advance to next Agent number (1 ~ 32).
5	After entering last data, press  to write the data.
6	Press  to go back on-line.

## Related Programming

M.B. Number	Memory Block Name
1-1-46	Access Code (1-Digit) Assignment
1-1-47	Access Code (2-Digit) Assignment
1-1-48	Access Code (3-Digit) Assignment
1-2-03	2-, 3-, or 4-Digit Station Number Selection



UCD and ACD cannot be installed in the same system.



# Voice Mail Quick Transfer Master Hunt Number

## General Description

Use this Memory Block to specify a Voice Mail Master Hunt Number to operate Quick Transfer to Voice Mail. This Memory Block also enables the voice mail display in the LCD of a Multiline Terminal when a voice mail machine sets a message.

## Display

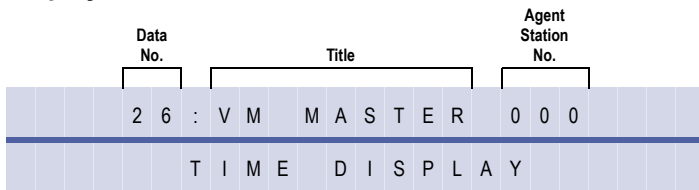









System Mode  
**1**

Submode  
**8**

Data No.  
**26**

PC Programming  
 + AV

## Programming Procedures

1	Go off-line.	
2	Press LK1 + LK8 +   to access the Memory Block.	
3	Use dial pad to enter agent station No. <b>Note:</b> Use the following to enter data: <ul style="list-style-type: none"> <li> ~  to enter numeric data</li> <li> to move cursor left</li> <li> to move cursor right</li> </ul> Agent station number is one of the following: <ul style="list-style-type: none"> <li>• 2 digit (00 ~ 99)</li> <li>• 3 digit (000 ~ 999)</li> <li>• 4 digit (0000 ~ 9999)</li> </ul>	<b>Default Values</b> Not Specified
4	Press  to write the data.	
5	Press  to go back on-line.	

## Related Programming

M.B. Number	Memory Block Name
1-1-46	Access Code (1-Digit) Assignment
1-1-47	Access Code (2-Digit) Assignment
1-1-48	Access Code (3-Digit) Assignment
1-2-08	2-, 3-, or 4-Digit Station Number Selection
1-2-24	Intercom Feature Access Code Assignment
4-14	Intercom Master Hunt Number Selection
4-15	Intercom Master Hunt Number Forward Assignment
4-35	Voice Mail/SLT Selection

# Forced Account Code Length Assignment

System Mode  
**1**

Submode  
**8**

Data No.  
**27**

PC Programming  
 + BF









## General Description

Use this Memory Block to assign the digit length of the Forced Account Codes.

## Display

Data No.	Title	Setting Data
27	FORCED	04DGT
TIME DISPLAY		

## Programming Procedures

<b>1</b>	Go off-line.	
<b>2</b>	Press LK1 + LK8 +   to access the Memory Block.	
<b>3</b>	Use dial pad to enter number of digits. <b>Note:</b> Use the following to enter data:  ~  to enter digits  to move cursor left  to move cursor right Setting Data = 01 ~ 13 digits	<b>Default Values</b> 4 Digits
<b>4</b>	Press  to write the data.	
<b>5</b>	Press  to go back on-line.	

## Related Programming

M.B. Number	Memory Block Name
<b>1-1-46 ~ 1-1-48</b>	Access Code (1-Digit) Assignment ~ Access Code (3-Digit) Assignment
<b>1-8-07</b>	Class of Service (Attendant) Feature Selection 1
<b>1-8-08</b>	Class of Service (Station) Feature Selection 2 Page 5, LK 1– Forced Account Code/Authorisation Code Page 6, LK 3 – Unverified for Forced Account Code/Authorisation Code
<b>4-07</b>	Code Restriction Class Assignment (Day Mode)
<b>4-08</b>	Code Restriction Class Assignment (Night Mode)
<b>4-17</b>	Station to Class of Service Feature Assignment
<b>4-64</b>	Timer Class Assignment for Telephone Mode Selection
<b>4-65</b>	Code Restriction Class Assignment CFVA Restricted Tel/Night Mode

# SCD (Simplified Call Distribution) Pilot Number Assignment

System Mode  
**1**

Submode  
**8**

Data No.  
**29**

PC Programming  
 + AA









## General Description

Use this Memory Block to define the SCD Pilot number for each of the four groups. It can be any valid unused station number.

## Display

Data No.	Title	Setting Data
29	PILOT	1
TIME DISPLAY		

## Programming Procedures

<b>1</b>	Go off-line.	
<b>2</b>	Press LK1 + LK8 +   to access the Memory Block.	
<b>3</b>	Use dial pad to enter an extension number. <b>Note:</b> Use the following to enter data:  ~  to enter digits  to move cursor left  to move cursor right	<b>Default Values</b> Not Assigned <b>Setting Data Extension No.</b> 00 ~ 99 000 ~ 999 0000 ~ 9999
<b>4</b>	Press  to write the data.	
<b>5</b>	Press  to go back on-line.	

## Related Programming

M.B. Number	Memory Block Name
<b>1-8-30</b>	SCD Group Agent Assignment

# SCD Group Agent Assignment

## General Description

Use this Memory Block to assign stations to one of four simplified call distribution groups. A total of 32 stations can be assigned.

## Display

Data No.	Title	Table No.	SCD Group No.	Setting Data
3 0	: S G	0 1	2 =	
T I M E D I S P L A Y				









System Mode  
**1**

Submode  
**8**

Data No.  
**30**

PC Programming  
 + AA

## Programming Procedures

<b>1</b>	Go off-line.	
<b>2</b>	Press LK1 + LK8 +   to access the Memory Block.	
<b>3</b>	Use dial pad to enter the station numbers. <b>Note:</b> Use the following to enter data:  ~  to enter digits  to move cursor left  to move cursor right	<b>Default Values</b> Not Assigned Setting Data SCD Group No. 1 ~ 4 Table No. 1 ~ 32 Extension No. 00 ~ 99 000 ~ 999 0000 ~ 9999
<b>4</b>	Press  to write the data.	
<b>5</b>	Press  to go back on-line.	

## Related Programming

M.B. Number	Memory Block Name
<b>1-8-29</b>	SCD (Simplified Call Distribution) Pilot Number Assignment

# Hold Tone Source Selection

## General Description

Use this Memory Block to assign an internal or external Music on Hold source.

## Display

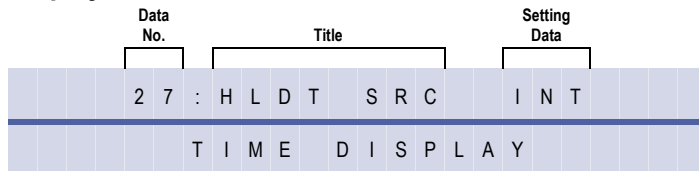

System Mode  
**1**

Submode  
**8**

Data No.  
**31**

PC Programming



## Settings

LK 1	LK 2	LK 3	LK 4
Int	Ext		

The shaded area indicates the default setting.

## Programming Procedures

1	Go off-line.	
2	Press LK1 + LK8 +   to access the Memory Block.	
3	Use the Line keys to select the Music On Hold source.	<b>Default Values</b> INT
4	Press  to write the data.	
5	Press  to go back on-line.	

## Related Programming

M.B. Number	Memory Block Name
1-8-09	Music on Hold Pattern Selection
1-8-32	Hold Internal Tone Volume Selection

# Hold Internal Tone Volume Selection

## General Description

When the internal Music On Hold source is used, this Memory Block is used to pad the music by -6 dB.

## Display

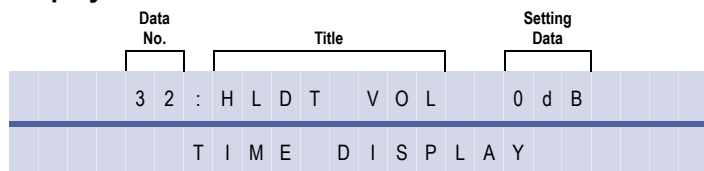

*System Mode*  
**1**

*Submode*  
**8**

*Data No.*  
**32**





*PC Programming*  
 + **BCS**

## Settings

LK 1	LK 2		
0 dB	-6 dB		

The shaded area indicates the default setting.

## Programming Procedures

1	Go off-line.	
2	Press LK1 + LK8 +   to access the Memory Block.	
3	Use Line keys to select the dB setting.	<b>Default Values</b> 0 dB
4	Press  to write the data.	
5	Press  to go back on-line.	

## Related Programming

M.B. Number	Memory Block Name
1-8-31	Hold Tone Source Selection

# Master Clock Selection

## General Description

When either a PRT(1)-U( ) or BRT(4)-U( ) ETU is installed, clocking must be synchronised. This Memory Block assigns the source to be synchronised with. Enter the cabinet/slot number of the PRT or BRT ETU to be used for synchronisation of the CLKG-U( ). This synchronised clock signal is then fed to each of the remaining BRT and PRT ETUs.

## Display

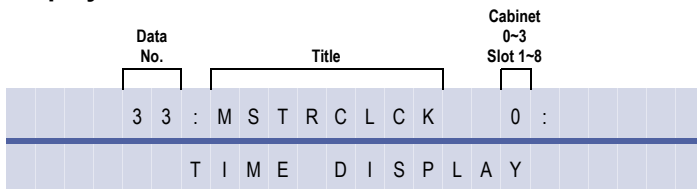

System Mode  
**1**  
 Submode  
**8**  
 Data No.  
**33**  
 PC Programming  
 + AN

## Programming Procedures

1	Go off-line.	
2	Press LK1 + LK8 +   to access the Memory Block.	
3	Use dial pad to enter number of digits. <b>Note:</b> Use the following to enter data: ~  to enter digits to move cursor left to move cursor right	<b>Default Values</b> Cabinet 0 (Not Assigned) <b>Setting Data</b> Cabinet 0 ~ 3 Slot 1 ~ 8
4	Press  to write the data.	
5	Press  to go back on-line.	

## Related Programming

M.B. Number	Memory Block Name
7-1	Card Interface Slot Assignment

## N

1. If the master clock selection is changed, all PRT calls may be disconnected as the resynchronisation occurs.
2. When a PRT or BRT ETU is installed, a CLKG-U( ) Unit must be fitted to the CPUI( )-U( ) ETU.
3. Ensure this Memory Block is set correctly when a BRI or PRI card is installed.
4. If Clock is not set, data services via ISDN may be affected.

# COM Port Baud Rate Setting Assignment

*System Mode*  
**1**  
*Submode*  
**8**  
*Data No.*  
**35**  
*PC Programming*  
 + **CSS**

## General Description

Use this Memory Block to define the baud rates for all three COM ports individually.

## Display

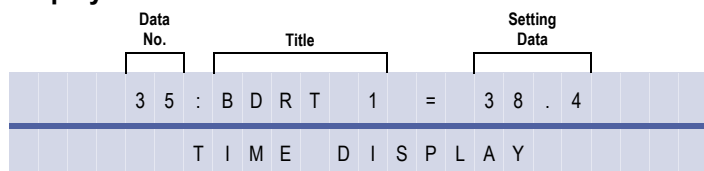





## Settings

LK 1	LK 2	LK 3	LK 4
4.8	9.6	19.2	38.4

The shaded area indicates the default setting.

## Programming Procedures

- 1 Go off-line.
- 2 Press LK1 + LK8 +   to access the Memory Block.
- 3 Use the Line keys to select the baud rate for each COM port.
 

**Default Values**  
 COM 1 = 38.4  
 COM 2 = 4.8  
 COM 3 = 9.6 (Not Used)
- 4 Press  to write the data.
- 5 Press  to go back on-line.

## Related Programming

M.B. Number	Memory Block Name
1-5-13	Printer Connected Selection



- COM 1 = PC Programming
- COM 1 = LGR
- COM 2 = Station Message Detail Recording (SMDR)
- COM 3 = Automatic Call Distribution



# COM Port Parity/Stop Bit Setting Assignment

## General Description

Use this Memory Block to define the Parity and Stop bit for the individual COM ports.

## Display

Data No.	Title	Setting Data
36	P / S 1	= N O N / 1
T I M E D I S P L A Y		

## Settings

LK 1	LK 2	LK 3	LK 4
Non/1	Non/2	Even/1	Odd/1
LK 5	LK 6	LK 7	LK 8

The shaded area indicates the default setting.

## Programming Procedures

1	Go off-line.	
2	Press LK1 + LK8 +   to access the Memory Block.	
3	Use the Line keys to select the parity and stop bit setting.	<b>Default Values</b> COM 1 = Non/1 COM 2 = Non/1 COM 3 = Non/1 (Not Used) COM 4 = Non/1
4	Press  to write the data.	
5	Press  to go back on-line.	

## Related Programming

M.B. Number	Memory Block Name
1-5-13	Printer Connected Selection



COM 1 = PC/LCR Programming  
 COM 2 = Station Message Detail Recording (SMDR)  
 COM 3 = Automatic Call Distribution

System Mode  
**1**  
 Submode  
**8**  
 Data No.  
**36**  
 PC Programming

# General Purpose Relay Assignment

## General Description

Use this Memory Block to specify whether or not the General Purpose Relays on the ECR-U13 ETU are used.

## Display

Data No.	Title	Setting Data
37	RELAY ( 0 , 1 )	NO
TIME DISPLAY		

System Mode  
**1**

Submode  
**8**

Data No.  
**37**





PC Programming  
 + BP

## Settings

LK 1	LK 2	LK 3	LK 4
No	Yes		
LK 5	LK 6	LK 7	LK 8

The shaded area indicates the default setting.

## Programming Procedures

1	Go off-line.	
2	Press LK1 + LK8 +   to access the Memory Block.	
3	Use the Line Keys to select the appropriate settings.	<b>Default Values</b> No
4	Press  to write the data.	
5	Press  to go back on-line.	

## Related Programming

M.B. Number	Memory Block Name
1-6-05	Attendant Add-On Console Key Selection



These General Purpose Relays are normally open relays.

# Modem Port for Remote Programming Assignment

## General Description









A socket modem can be installed on the MIFM-U( ) ETU when it is installed in S1 or S2 of the B64-U23 KSU. Use this Memory Block to assign the extension number for the socket modem.

## Display

Data No.	Title	Setting Data
38	MODEM	=
TIME DISPLAY		

*System Mode*  
**1**  
*Submode*  
**8**  
*Data No.*  
**38**  
*PC Programming*  
 + CSS

## Programming Procedures

1	Go off-line.	
2	Press LK1 + LK8 +   to access the Memory Block.	
3	Use dial pad to enter number of digits. <b>Note:</b> Use the following to enter data:  ~  to enter digits  to move cursor left  to move cursor right	<b>Default Values</b> Not assigned <b>Setting Data Extension No.</b> 00 ~ 99 000 ~ 999 0000 ~ 9999
4	Press  to write the data.	
5	Press  to go back on-line.	

## Related Programming

M.B. Number	Memory Block Name
7-1	Card Interface Slot Assignment

# N

Modem Extension number is a phantom number. It does not have to be assigned in MB 4-10.

# ACD Hunt Timer

## General Description

Use this Memory Block to assign the time value for hunting among the Automatic Call Distribution/Uniform Call Distribution (ACD/UCD) agents that do not answer an ACD/UCD call.

## Display

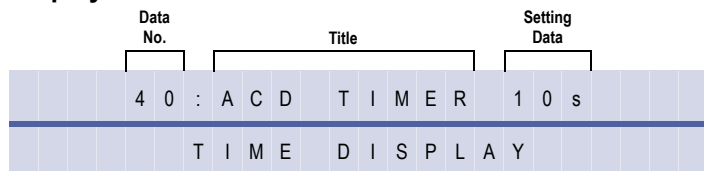

System Mode  
**1**

Submode  
**8**

Data No.  
**40**

PC Programming  
 + AA

## Settings

LK 1	LK 2	LK 3	LK 4
10 sec.	20 sec.	30 sec.	60 sec.
LK 5	LK 6	LK 7	LK 8
120 sec.	240 sec.	No Limit	

The shaded area indicates the default setting.

## Programming Procedures

1	Go off-line.	
2	Press LK1 + LK8 +   to access the Memory Block.	
3	Use the Line keys to assign the new value.	<b>Default Values</b> 10 seconds
4	Press  to write the data.	
5	Press  to go back on-line.	

## Related Programming

M.B. Number	Memory Block Name
1-8-25	ACD/UCD Group Agent Assignment
1-12-00	ACD/UCD Group Pilot Number Assignment
1-12-01	ACD/UCD Group Overflow Destination Assignment
1-12-02	ACD/UCD Overflow Timer Selection

# CAR for Voice Mail Message Notice Assignment

System Mode  
**1**

Submode  
**8**

Data No.  
**47**

PC Programming  
 + AV







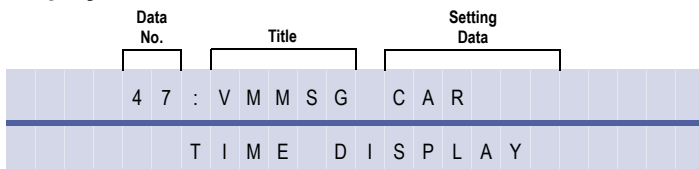



## General Description

Use this Memory Block to assign the Call Arrival Key that is used to send Voice Mail message notification to other systems.

## Display



## Programming Procedures

<b>1</b>	Go off-line.		
<b>2</b>	Press LK1 + LK8 +   to access the Memory Block.		
<b>3</b>	Use the dial pad to enter data. <b>Note:</b> Use the following to enter data: <ul style="list-style-type: none"> <li> ~  to enter Automated Attendant message number</li> <li> to move the cursor LEFT</li> <li> to move the cursor RIGHT</li> <li> ~  to enter numeric data</li> </ul> 2-Digit CAR: 10~99 3-Digit CAR: 100~999 4-Digit CAR: 1000~9999 H : to clear all data when cursor is at setting position.(Depends what length the extension number has been assigned in HB1-2-03.)	<b>Default Values</b> Not assigned.	
<b>4</b>	Press  to write the data.		
<b>5</b>	Press  to go back on-line.		

## Related Programming

M.B. Number	Memory Block Name
<b>1-1-46</b>	Access Code (1-Digit) Assignment
<b>1-1-47</b>	Access Code (2-Digit) Assignment
<b>1-2-03</b>	2-, 3-, or 4-Digit Station Number Selection
<b>1-2-04</b>	Call Arrival Key Block Assignment
<b>4-10</b>	Station Number Assignment

## Related Programming

No related programming is necessary for this Memory Block.

Doc. No.: 8194 - Release 2.0  
December 2004

# New AA-Info Yes/No Selection

## General Description

Use this Memory Block to specify whether or not New AA-Info is allowed. New Application-to-Application (AA) Info is used with internal Voice Mail Systems (i.e., FMS( )-U( ) or VMS( )-U( ) ETUs. For external digital Voice Mail System and VP/CTI Systems, this Memory Block must be set to NO.

**System Software R2000 or higher is required.**

## Display





Data No.	Title	Setting Data
49	NEW AA INFO	YS
TIME DISPLAY		

## Settings

LK 1	LK 2	LK 3	LK 4	LK 5	LK 6	LK 7	LK 8
NO	YS						

The shaded area indicates the default setting.

## Programming Procedures

- 1 Go off-line.
- 2 Press LK1 + LK8 +   to access the Memory Block.
- 3 Press the corresponding CO/PBX line key to change the setting option.
- 4 Press  to write the selected data and display next Memory Block or Memory Block 1-8-00.
- 5 Press  to go back on-line.

## Related Programming

M.B. Number	Memory Block Name
1-1-46	Access Code (1-Digit) Assignment
1-1-47	Access Code (2-Digit) Assignment
1-2-03	2-, 3-, or 4-Digit Station Number Selection
1-2-04	Call Arrival Key Block Assignment
4-10	Station Number Assignment

## Related Programming

No related programming is necessary for this Memory Block.

System Mode  
**1**

Submode  
**8**

Data No.  
**49**

PC Programming  
 + AV

# DISA/ID Code Assignment

## General Description

This Memory Block specifies the Direct Inward System Access (DISA) ID Code numbers.

## Display

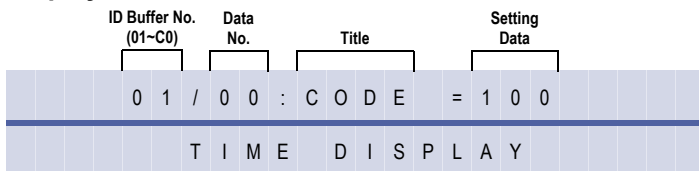

*System Mode*  
**1**  
*Submode*  
**9**  
*Data No.*  
**00**  
*PC Programming*  
 + **BD**

## Programming Procedures

<b>1</b>	Go off-line.	
<b>2</b>	Press LK1 + LK9 +   to access the Memory Block.	
<b>3</b>	Use the dial pad to enter the data. <b>Setting Data:</b> 2-digit DISA ID Code: 00~99 (00 no data) 3-digit DISA ID Code: 000~999 (000 no data) 4-digit DISA ID Code: 0000~9999 (0000 no data) <b>Note:</b> Use the following to enter data: to move the cursor left to move the cursor right ~  to enter numeric data to access the next ID buffer number +1, 2, 3 = A, B, or C for Port Number <b>ID Buffer Number:</b> 01~99 A0~A9 B0~B9 C0	<b>Default Values</b> If DISA ID Code is assigned as 2-digit: ID Buffer Number 01~10 = DISA ID Code 10~19 ID Buffer Number 11~20 = DISA ID Code 20~29, etc. If DISA ID Code is assigned as 3-digit: ID Buffer Number 01~C0 = DISA ID Code 100~219 If DISA ID Code is assigned as 4-digit: ID Buffer Number 01~10 = DISA ID Code 1000~1009 ID Buffer Number 11~20 = DISA ID Code 1010~1019, etc.
<b>4</b>	Press  to write the data.	
<b>5</b>	Repeat Steps 3 and 4 for each remaining sequential ID Buffer No. displayed after each password choice is made in Memory Block 1-9-02.	
<b>6</b>	Press  to go back on-line.	

## Related Programming

No related programming is necessary for this Memory Block.

# N

1. Assign 000 (No Data) for stations that are not installed or stations that are denied DISA access.
2. This Memory Block cycles through ID Buffer Nos. alternating with Memory Block 1-9-02 password specification for each Buffer No.

# DISA/ID Password Effect/ Invalid Selection

*System Mode*  
**1**

*Submode*  
**9**

*Data No.*  
**02**

*PC Programming*  
 + **BD**

## General Description

Use this Memory Block to assign a Direct Inward System Access (DISA) Password as Invalid (LK1) or Effective (LD2). If invalid is assigned, the calling party can use the DISA feature without a DISA Password.

## Display











ID Buffer No. (01~C0)	Data No.	Title	Setting Data
01	/ 02	P A S S W O R D =	Y S
T I M E D I S P L A Y			

## Settings

LK 1	LK 2	LK 3	LK 4
No	Yes		
LK 5	LK 6	LK 7	LK 8

The shaded area indicates the default setting.

## Programming Procedures

<b>1</b>	Go off-line.
<b>2</b>	Press LK1 + LK9 +   to access the Memory Block.
<b>3</b>	<p>Press the corresponding CO/PBX line key to change the data option.</p> <p><b>Setting Data:</b>                      NO (LK1) = DISA Password Invalid (Password is not required).                      YES (LK2) = DISA Password in Effect (Password is required. Assign with MB , 1-1-46~, 1-1-48).</p> <p><b>Note:</b> Use the following to enter data:   to move the cursor left   to move the cursor right   ~  to enter numeric data   to access the next ID buffer number   +1, 2, 3 = A, B, or C for Port Number</p> <p><b>ID Buffer Number:</b>                      01~99 = 01~99                      A0~A9 = 100~109                      B0~B9 = 110~119                      C0 = 120</p>
<b>4</b>	Press  to write the data.
<b>5</b>	Press  to go back on-line.

## Related Programming

M.B. Number	Memory Block Name
	Refer to <i>Chapter 2, Guide to Feature Programming.</i>



# ID Restriction Class Assignment (Day Mode)

System Mode  
**1**

Submode  
**9**

Data No.  
**03**

PC Programming

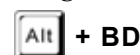

## General Description

Use this Memory Block to specify the DAY mode code restriction classes for each ID number.

## Display

ID Buffer No. (01~96)	Data No.	Title	Setting Data
01	03	CLS DAY	= 00
TIME DISPLAY			

## Programming Procedures

1	Go off-line.	
2	Press LK1 + LK9 +   to access the Memory Block.	
3	Use the dial pad to enter the data. <b>Setting Data:</b> Code Restriction Class 00 ~ 15 <b>Note:</b> Use the following to enter data: <ul style="list-style-type: none"> <li> to move the cursor left</li> <li> to move the cursor right</li> <li> ~  to enter numeric data</li> <li> to access the next ID buffer number</li> <li> +1, 2, 3 = A, B, or C for Port Number</li> </ul> <b>ID Buffer Number:</b> 01~99 = 01~99 A0~A9 = 100~109 B0~B9 = 110~119 C0 = 120	<b>Default Values</b> ID Buffer No. 01~120 = Code Restriction Class No.00
4	Press  to write the data.	
5	Press  to go back on-line.	

## Related Programming

M.B. Number	Memory Block Name
1-1-19	Line Selection for Automatic Outgoing Calls
1-1-46	DID Digit Length Selection
1-1-47	DID Digit Conversion Assignment
1-1-48	DID Forward Station Number for Busy Station or Undefined Digit
1-5-23	Outgoing Mode Selection
1-9-00	DISA/ID Code Assignment
1-9-02	DISA/ID Password Effect/Invalid Selection
1-9-03	ID Restriction Class Assignment (Day Mode)
1-9-04	ID Restriction Class Assignment (Night Mode)

**Related Programming (Continued)**

M.B. Number	Memory Block Name
4-26	DISA/ID Number Station Assignment
4-27	ID Outgoing Restriction Selection

# ID Restriction Class Assignment (Night Mode)

System Mode  
**1**

Submode  
**9**

Data No.  
**04**

PC Programming

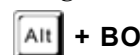

## General Description

Use this Memory Block to specify the NIGHT mode code restriction classes for each ID number.

## Display

ID Buffer No. (01~96)	Data No.	Title	Setting Data
01	/ 04	: C L S N T	= 00
T I M E D I S P L A Y			

## Programming Procedures

1	Go off-line.	
2	Press LK1 + LK9 +   to access the Memory Block.	
3	Use the dial pad to enter the data. <b>Setting Data:</b> Code Restriction Class 00 ~ 15 <b>Note:</b> Use the following to enter data: <ul style="list-style-type: none"> <li> to move the cursor left</li> <li> to move the cursor right</li> <li> ~  to enter numeric data</li> <li> to access the next ID buffer number</li> <li> +1, 2, 3 = A, B, or C for Port Number</li> </ul> <b>ID Buffer Number:</b> <ul style="list-style-type: none"> <li>01~99 = 01~99</li> <li>A0~A9 = 100~109</li> <li>B0~B9 = 110~119</li> <li>C0 = 120</li> </ul>	<b>Default Values</b> ID Buffer No. 01~120 = Code Restriction Class No.00
4	Press  to write the data.	
5	Press  to go back on-line.	

## Related Programming

M.B. Number	Memory Block Name
1-1-19	Line Selection for Automatic Outgoing Calls
1-1-46	DID Digit Length Selection
1-1-47	DID Digit Conversion Assignment
1-1-48	DID Forward Station Number for Busy Station or Undefined Digit
1-5-23	Outgoing Mode Selection
1-9-00	DISA/ID Code Assignment
1-9-02	DISA/ID Password Effect/Invalid Selection
1-9-03	ID Restriction Class Assignment (Day Mode)
1-9-04	ID Restriction Class Assignment (Night Mode)OMU

**Related Programming (Continued)**

M.B. Number	Memory Block Name
4-26	DISA/ID Number Station Assignment
4-27	ID Outgoing Restriction Selection

# T1 Signal Format Selection

## General Description

Use this Memory Block to specify the signal format of the T1 trunk connected to the system. The signal format used (12- or 24-Multiframe) depends on the channel service unit/demarcation (CSU/D mark) equipment being used.

**System Software R2000 or higher is required.**

## Display

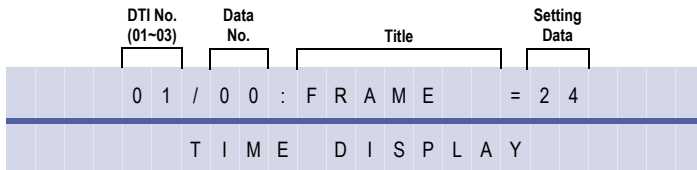

## Settings

LK1	LK2	LK3	LK4	LK5	LK6	LK7	LK8
12 (SF)	24 (ESF)						

The shaded area indicates the default setting.

## Programming Procedures

1	Go off-line.
2	Press LK1 + LK11 to access the Memory Block.
3	Press the corresponding CO/PBX line key to change the data option. <b>Note:</b> Setting Data: SF = Superframe Format (12-Multiframe) ESF = Extended Superframe Format (24-Multiframe)
4	Press <b>Transfer</b> to write the data. The next Memory Block is displayed.
5	Program the next Memory Block or press <b>Speaker</b> to go back on-line.

## Related Programming

M.B. Number	Memory Block Name
7-1	Card Interface Slot Assignment

## Related Programming

No related programming is necessary for this Memory Block.



The DTI-U( ) ETU must be assigned in the system to set this Memory Block.

System Mode  
**1**

Submode  
**11**

Data No.  
**00**

PC Programming  
**Alt + AD**

# Clear Channel Selection

## General Description

Use this Memory Block to specify the clear channel selection. when the Zero Byte Time channel is available, the CLKG-U( ) Unit cannot extract a clock signal from the T1 trunk. The T1 trunk modifies the Zero Byte Time channel to extract a clock signal for the CLKG-U( ) Unit.

Applicable for R2000 and above.

## Display





DTI No. (01-08)	Data No.	Title	Setting Data
01	01	O B Y T E = Z C S	
T I M E D I S P L A Y			

## Settings

LK1	LK2	LK3	LK4	LK5	LK6	LK7	LK8
ZCS	B8ZS						

The shaded area indicates the default setting.

## Programming Procedures

- 1 Go off-line.
- 2 Press LK1 + LK11 +   to access the Memory Block.
- 3 Press the corresponding CO/PBX line key to change the data option.
- 4 Press  to write the data. The next Memory Block is displayed.
- 5 Program the next Memory Block or press  to go back on-line.

## Related Programming

M.B. Number	Memory Block Name
7-1	Card Interface Slot Assignment



The DTI-U( ) ETU must be assigned in the system to set this Memory Block.

System Mode  
**1**

Submode  
**11**

Data No.  
**01**

PC Programming  
 + AD

# Line Length Selection

## General Description

Use this Memory Block to specify the distance, in feet, between the channel service unit/demarcation (CSU/D mark) and the DTI-U( ) ETU. This specifies the equalization values of the detect signal in the DTI-U( ) ETU.

Applicable for R2000 and above.

## Display

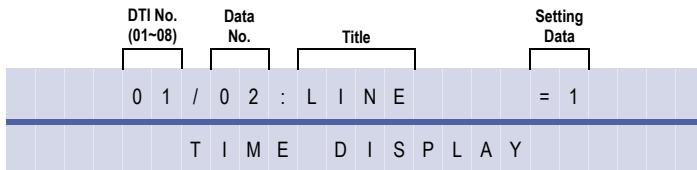

System Mode  
**1**

Submode  
**11**

Data No.  
**02**

PC Programming

+ AD

## Settings

LK1	LK2	LK3	LK4	LK5	LK6	LK7	LK8
1 (0-131)	2 (132-262)	3 (263-393)	4 (394-524)	5 (525-655)			

The shaded area indicates the default setting.

## Programming Procedures

- Go off-line.
- Press LK1 + LK11 + to access the Memory Block.
- Press the corresponding CO/PBX line key to change the data option.
 

Line Key	LCD Indication	Description
LK1	1	0~131 Feet
LK 2	2	132~262 feet
LK 3	3	263~393 feet
LK 4	4	394~524 feet
LK 5	5	525~655 feet
- Press to write the data. The next Memory Block is displayed.
- Program the next Memory Block or press to go back on-line.

## Related Programming

M.B. Number	Memory Block Name
7-1	Card Interface Slot Assignment

# N

The DTI-U( ) ETU must be assigned in the system to set this Memory Block.

# IP K-CCIS Selection

## General Description

Use this Memory Block to assign the IAD(8)-U( ) ETU used for K-CCIS over IP.

Applicable for R2000 and above.

## Display

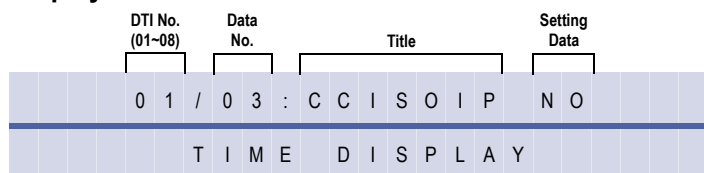

System Mode  
**1**

Submode  
**11**

Data No.  
**03**

PC Programming  
 + AD

## Programming Procedures

1	Go off-line.
2	Press LK1 + LK11 +   to access the Memory Block.
3	Press the corresponding CO/PBX line key to change the data option.
4	Press  to write the data. The next Memory Block is displayed.
5	Program the next Memory Block or press  to go back on-line.

## Related Programming

M.B. Number	Memory Block Name
7-1	Card Interface Slot Assignment
1-15-05	Destination Point Code Transfer Assignment
1-15-06	Originating Office Code Number Assignment
1-15-07	K-CCIS Message Response Timeout Assignment
1-15-08	Link Reconnect Allow/Deny Selection
1-15-09	K-CCIS Maximum Call Forwarding Hop Assignment
1-15-11	Centralised Billing Allow/Deny Selection
1-15-12	Centralised Billing - Point Code of Center Office Assignment
1-15-13	Centralised Day/Night Switching for Remote Office Assignment
1-15-14	Centralised Day/Night Switching for Main Office Assignment
1-15-15	Centralised BLF Send Point Code Assignment
1-15-16	Centralised BLF Send Extension Number Assignment
1-15-17	Centralised BLF Send Time Assignment
1-15-18	Centralised BLF Display Extension Number Assignment

# N

- The IAD(8)-U( ) ETU is programmed as a DTI (DTI4 or DTI8) ETU in Memory Block 7-1 (Card Interface Slot Assignment) when used for K-CCIS over IP.
- Assign this Memory Block to YS when IAD(8)-U( ) ETUs are installed with one of the following applications loaded.  
IP CCH ETU [IP(K-CCIS)]  
IP CCH ETU for NEAX [IP(K-CCIS) to NEAX (Point-to-Multipoint)]



# TI Channel Selection

## General Description

Use this Memory Block to specify the digital trunk interface (DTI) channel numbers to be used. DTI Trunks 1 and 2 have a maximum of 24 channels, and DTI Trunk 3 has a maximum of 16 channels.

Applicable for R2000 and above.

## Display

DTI No. (01~08)	Data No.	Title	Setting Data
0 1	/ 0 5	C H A N N E L	0 1
T I M E D I S P L A Y			





System Mode  
**1**

Submode  
**11**

Data No.  
**05**

PC Programming  
 + AD

## Programming Procedures

<b>1</b>	Go off-line.																														
<b>2</b>	Press LK1 + LK11 +   to access the Memory Block.																														
<b>3</b>	Press the corresponding CO/PBX line key to select DTI channel number.	<p><b>Default Values</b></p> <p>DTI No. 1 Channels 01~24 = Off                  DTI No. 2 Channels 01~24 = Off                  DTI No. 3 Channels 01~24 = Off                  DTI No. 4 Channels 01~24 = Off                  DTI No. 5 Channels 01~24 = Off                  DTI No. 6 Channels 01~24 = Off                  DTI No. 7 Channels 01~24 = Off                  DTI No. 8 Channels 01~24 = Off</p>																													
	<table border="1" style="width: 100%;"> <thead> <tr> <th rowspan="2">CO/PBX Line Key</th> <th colspan="3">Channel No.</th> <th rowspan="2">Page</th> </tr> <tr> <th>DTI No. 1</th> <th>DTI No. 2</th> <th>DTI No. 3~8</th> </tr> </thead> <tbody> <tr> <td>01~08</td> <td>01~08</td> <td>01~08</td> <td>01~08</td> <td>1</td> </tr> <tr> <td>09~16</td> <td>09~16</td> <td>09~16</td> <td>09~16</td> <td>2</td> </tr> <tr> <td>17~24</td> <td>17~24</td> <td>17~24</td> <td>17~24</td> <td>3</td> </tr> </tbody> </table> <table border="1" style="width: 100%;"> <thead> <tr> <th>CO/PBX Line LED</th> <th>Off</th> <th>On</th> </tr> </thead> <tbody> <tr> <td>Data</td> <td>NO (Not Assigned)</td> <td>YES (Assigned)</td> </tr> </tbody> </table>	CO/PBX Line Key	Channel No.			Page	DTI No. 1	DTI No. 2	DTI No. 3~8	01~08	01~08	01~08	01~08	1	09~16	09~16	09~16	09~16	2	17~24	17~24	17~24	17~24	3	CO/PBX Line LED	Off	On	Data	NO (Not Assigned)	YES (Assigned)	
CO/PBX Line Key	Channel No.			Page																											
	DTI No. 1	DTI No. 2	DTI No. 3~8																												
01~08	01~08	01~08	01~08	1																											
09~16	09~16	09~16	09~16	2																											
17~24	17~24	17~24	17~24	3																											
CO/PBX Line LED	Off	On																													
Data	NO (Not Assigned)	YES (Assigned)																													
<b>4</b>	Press  to write the data. The next Memory Block is displayed.																														
<b>5</b>	Program the next Memory Block or press  to go back on-line.																														

## Related Programming

M.B. Number	Memory Block Name
<b>7-1</b>	Card Interface Slot Assignment



The DTI-U( ) ETU must be assigned in the system to set this Memory Block.

# Signalling Selection

## General Description

Use this Memory Block to specify Loop Start (LS) or Ground Start (GS) Trunk Signalling when using T1.

Applicable for R2000 and above.

## Display

DTI No. (01-08)	Data No.	Title	Setting Data
0 1	/ 0 6	: T R N K 0 1	= L S
T I M E D I S P L A Y			

System Mode  
**1**

Submode  
**11**

Data No.  
**06**





PC Programming  
 + AD

## Settings

LK1	LK2	LK3	LK4	LK5	LK6	LK7	LK8
LS	GS						

The shaded area indicates the default setting.

## Programming Procedures

- 1 Go off-line.
- 2 Press LK1 + LK11 +   to access the Memory Block.
- 3 Press the corresponding CO/PBX line key to change the data option.
- 4 Press  to write data and advance to the next Channel No.
- 5 Program the next Memory Block or press  to go back on-line.

## Related Programming

M.B. Number	Memory Block Name
1-11-07	DTI Trunk Type Assignment
7-1	Card Interface Slot Assignment



The DTI-U( ) ETU must be assigned in the system to set this Memory Block.

# DTI Trunk Type Assignment

System Mode  
**1**

Submode  
**11**

Data No.  
**07**

PC Programming  
 + AD

### General Description

Use this Memory Block to assign the trunk type (CO/E&M Tie line/DID/ANI) four channels at a time. Assignment to an individual channel is impossible.

**Applicable for R2000 and above.**

### Display



DTI No. (01~08)	Data No.	Title	Setting Data
0 1 /	0 7	T R K ( 1 )	C O
T I M E D I S P L A Y			



### Settings

LK1	LK2	LK3	LK4	LK5	LK6	LK7	LK8
CO	E&M	DID	ANI				

The shaded area indicates the default setting.

### Programming Procedures

- 1 Go off-line.
- 2 Press LK1 + LK11 +   to access the Memory Block.
- 3 Press the corresponding CO/PBX line key to change the data option.
 

Block No.	4-Channel Unit		
	DTI No. 1	DTI No. 2	DTI No. 3~8
1	01~04	01~04	01~04
2	05~08	05~08	05~08
3	09~12	09~12	09~12
4	13~16	13~16	13~16
5	17~20	17~20	17~20
6	21~24	21~24	21~24
- 4 Press  to write the data. The next Memory Block is displayed.
- 5 Program the next Memory Block or press  to go back on-line.

### Related Programming

M.B. Number	Memory Block Name
<b>1-11-06</b>	Signalling Selection
<b>7-1</b>	Card Interface Slot Assignment

## N

1. A DTI-U( ) ETU must be assigned in the system to set this Memory Block.
2. When the default setting is changed to E&M or DID, the affected trunks are automatically reassigned to Trunk Group 00. When trunks 01 ~ 08 are affected, default line key assignment for all Multiline Terminals changes to Not Used and must also be reassigned. Memory Block 3-14 resets to second dial.

# Digits Delete for TI ANI Assignment

System Mode  
**1**

Submode  
**11**

Data No.  
**08**

PC Programming  
 + AD

## General Description





Use this Memory Block to delete the Information Digits received from the Network on Feature Group D Trunks.

Applicable for R2000 and above.

## Display

DTI No. (01~08)	Data No.	Block 1~6	Title	Setting Data
0 1 /	0 8 :	1 -	D E L	2 D G T
T I M E D I S P L A Y				

## Programming Procedures

<b>1</b>	Go off-line.																																
<b>2</b>	Press LK1 + LK11 +   to access the Memory Block.																																
<b>3</b>	Use the dial pad to enter Setting Data 1 and Setting Data 2. <i>Note:</i> Use the following to enter data: * to move cursor left. # to move cursor right. 0 ~ 9 to enter data 0 ~ 9 to change DTI number  <i>Note:</i> Setting Data 1: Press the corresponding CO/PBX line key to change the data option.	<b>Default Values</b> 2																															
	<table border="1" style="width: 100%; border-collapse: collapse; text-align: center;"> <thead> <tr> <th rowspan="2">Block No.</th> <th colspan="3">4-Channel Unit</th> </tr> <tr> <th>DTI No. 1</th> <th>DTI No. 2</th> <th>DTI No. 3~8</th> </tr> </thead> <tbody> <tr><td>1</td><td>01~04</td><td>01~04</td><td>01~04</td></tr> <tr><td>2</td><td>05~08</td><td>05~08</td><td>05~08</td></tr> <tr><td>3</td><td>09~12</td><td>09~12</td><td>09~12</td></tr> <tr><td>4</td><td>13~16</td><td>13~16</td><td>13~16</td></tr> <tr><td>5</td><td>17~20</td><td>17~20</td><td>17~20</td></tr> <tr><td>6</td><td>21~24</td><td>21~24</td><td>21~24</td></tr> </tbody> </table>	Block No.	4-Channel Unit			DTI No. 1	DTI No. 2	DTI No. 3~8	1	01~04	01~04	01~04	2	05~08	05~08	05~08	3	09~12	09~12	09~12	4	13~16	13~16	13~16	5	17~20	17~20	17~20	6	21~24	21~24	21~24	
Block No.	4-Channel Unit																																
	DTI No. 1	DTI No. 2	DTI No. 3~8																														
1	01~04	01~04	01~04																														
2	05~08	05~08	05~08																														
3	09~12	09~12	09~12																														
4	13~16	13~16	13~16																														
5	17~20	17~20	17~20																														
6	21~24	21~24	21~24																														
	<i>Note:</i> Setting Data 2: 0 No Delete 1~9 Number of Digits to Delete																																
<b>4</b>	Press  to write the data. Memory Block 1-11-00 is displayed.																																
<b>5</b>	Program Memory Block 1-11-00 again or press  to go back on-line.																																

**Related Programming**

M.B. Number	Memory Block Name
7-1	Card interface Slot Assignment
1-11-05	T1 Channel Selection
1-11-07	DTI Trunk Type Assignment

**N**

Example of ANI information: KP**009727517645**STKP**7100**ST.

**00** Information digits

**9727517645** ANI information

**7100** DNIS Digits

THIS PAGE INTENTIONALLY LEFT BLANK

# ACD/UCD Group Pilot Number Assignment

## General Description

Use this Memory Block to specify the Pilot Number of an Automatic Call Distribution/Uniform Call Distribution (ACD/UCD) Group where incoming calls are terminated.

## Display

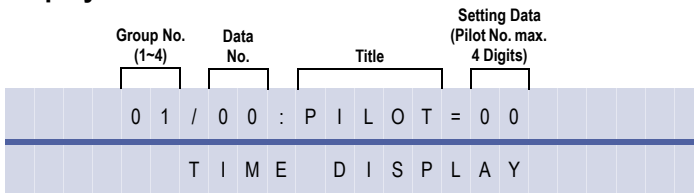









System Mode  
**1**

Submode  
**12**

Data No.  
**00**

PC Programming  
 + AA

## Programming Procedures

<b>1</b>	Go off-line.	
<b>2</b>	Press LK1 + LK12 +   to access the Memory Block.	
<b>3</b>	Enter data using the dial pad. <b>Note:</b> Use the following to enter data: <ul style="list-style-type: none"> <li> to move the cursor left</li> <li> to move the cursor right</li> <li> ~  to enter numeric data</li> </ul> <b>Settings:</b> Pilot No. (00~99) 2-digit (00~99) 3-digit (000~999) 4-digit (0000~9999)	<b>Default Values</b> Not Specified
<b>4</b>	Press  to write the data.	
<b>5</b>	Press  to go back on-line.	

## Related Programming

M.B. Number	Memory Block Name
<b>1-1-46</b>	Access Code (1-Digit) Assignment
<b>1-1-47</b>	Access Code (2-Digit) Assignment
<b>1-1-48</b>	Access Code (3-Digit) Assignment
<b>1-2-03</b>	2-, 3-, or 4-Digit Station Number Selection
<b>1-8-25</b>	ACD/UCD Group Agent Assignment
<b>1-12-01</b>	ACD/UCD Group Overflow Destination Assignment

# ACD/UCD Group Overflow Destination Assignment

*System Mode*  
**1**

*Submode*  
**12**

*Data No.*  
**01**

*PC Programming*  
 + AA







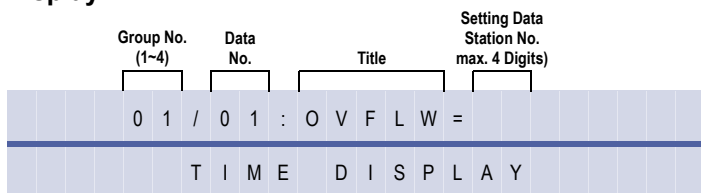

## General Description

This Memory Block specifies the station or Station Hunt Group where the overflow call of each Automatic Call Distribution/Uniform Call Distribution (ACD/UCD) Group is routed when incoming calls overflow.

## Display



## Programming Procedures

<b>1</b>	Go off-line.		
<b>2</b>	Press LK1 + LK12 +   to access the Memory Block.		
<b>3</b>	Enter data using the dial pad. <b>Note:</b> The following are used when entering data: <ul style="list-style-type: none"> <li> to move the cursor left</li> <li> to move the cursor right</li> <li> ~  to enter numeric data</li> </ul> <b>Settings:</b> Station No. (00~99) 2-digit (00~99) 3-digit (000~999) 4-digit (0000~9999)	<b>Default Values</b> Not Specified	
<b>4</b>	Press  to write the data.		
<b>5</b>	Press  to go back on-line.		

## Related Programming

M.B. Number	Memory Block Name
<b>1-1-46</b>	Access Code (1-Digit) Assignment
<b>1-1-47</b>	Access Code (2-Digit) Assignment
<b>1-1-48</b>	Access Code (3-Digit) Assignment
<b>1-2-03</b>	2-, 3-, or 4-Digit Station Number Selection
<b>1-8-25</b>	ACD/UCD Group Agent Assignment



1. An ACD/UCD Group Pilot Number cannot be programmed as the overflow destination.
2. UCD and ACD cannot be installed in the same system.



# ACD/UCD Overflow Timer Selection

System Mode  
**1**

Submode  
**12**

Data No.  
**02**

PC Programming  
 + AA

## General Description

This Memory Block specifies the maximum time a waiting Automatic Call Distribution/Uniform Call Distribution (ACD/UCD) call remains at an ACD/UCD Group before overflowing to a specified Station or Station Hunt Group.

## Display

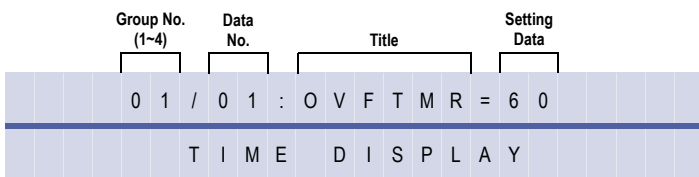





## Settings

LK 1	LK 2	LK 3	LK 4
•	10 sec.	20 sec.	30 sec.
LK 5	LK 6	LK 7	LK 8
60 sec.	120 sec.	180 sec.	240 sec.

The shaded area indicates the default setting.

## Programming Procedures

<b>1</b>	Go off-line.
<b>2</b>	Press LK1 + LK12 +   to access the Memory Block.
<b>3</b>	Press the corresponding CO/PBX line key to change the data option.
<b>4</b>	Press  to write the data.
<b>5</b>	Press  to go back on-line.

## Related Programming

M.B. Number	Memory Block Name
<b>1-1-46</b>	Access Code (1-Digit) Assignment
<b>1-1-47</b>	Access Code (2-Digit) Assignment
<b>1-1-48</b>	Access Code (3-Digit) Assignment
<b>1-2-03</b>	2-, 3-, or 4-Digit Station Number Selection
<b>1-8-25</b>	ACD/UCD Group Agent Assignment
<b>1-12-01</b>	ACD/UCD Group Overflow Destination Assignment



An ACD/UCD Group Pilot Number cannot be programmed as the overflow destination.

THIS PAGE INTENTIONALLY LEFT BLANK

# PRI Channel Assignment

## General Description

This Memory Block specifies the number of channels available on each PRI ISDN line connected to the system via a PRT(1)-U( ) ETU.

## Display

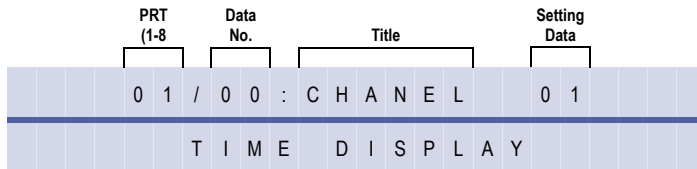

System Mode  
**1**

Submode  
**13**

Data No.  
**00**

PC Programming  
 + AN

## Settings

### Page 1

LK 1	LK 2	LK 3	LK 4	LK 5	LK 6	LK 7	LK 8
Channel 1	Channel 2	Channel 3	Channel 4	Channel 5	Channel 6	Channel 7	Channel 8

### Page 2

LK 1	LK 2	LK 3	LK 4	LK 5	LK 6	LK 7	LK 8
Channel 9	Channel 10	Channel 11	Channel 12	Channel 13	Channel 14	Channel 15	Channel 16

### Page 3

LK 1	LK 2	LK 3	LK 4	LK 5	LK 6	LK 7	LK 8
Channel 17	Channel 18	Channel 19	Channel 20	Channel 21	Channel 22	Channel 23	Channel 24

### Page 4

LK 1	LK 2	LK 3	LK 4	LK 5	LK 6	LK 7	LK 8
Channel 25	Channel 26	Channel 27	Channel 28	Channel 29	Channel 30		

The shaded area indicates the default setting.

CO/PBX Line LED	Off	On
Data	No (Not Assigned)	Yes (Assigned)

The shaded selection is the default

## Programming Procedures

- 1 Go off-line.
- 2 Press LK1+ LK13 + to access the Memory Block.
- 3 Press the corresponding CO/PBX line key to change the data option.
- 4 Press to write the data.
- 5 Press to go back on-line.

## Related Programming

M.B. Number	Memory Block Name
7-1	Card Interface Slot Assignment
3-92	Trunk (Installed, DP/DTMF) Selection
1-8-33	Master Clock Selection
3-57	ISDN Dial-Out Sending Selection

---

# N

1. PRT defaults as PRT 32.  
Memory Block 1-13-04 must then be programmed to show the exact number of available channel.
2. Two slots will be used for 30 B channel PRT, PRT 20, 10 take one slot.
3. As channel 16 is a signalling channel, it cannot be set.
4. Only 16 Channels can be assigned with the Elite IPK Basic Port Package.
5. UP to eight PRT ETUs can be assigned.
6. The number of available channels depends on the PRT(1)-U( ) assigned in Memory Block 7-1.
7. For example, when PRT8 is assigned in Memory Block 7-1, any eight channels can be assigned (allowed) in this Memory Block. Any channel skipped (Not Assigned) is still an available channel from 0 to the last assigned channel.
8. A PRT(1)-U( ) ETU must be assigned in the system to set this Memory Block.

# PRT B Channel Outgoing Priority Selection

System Mode  
**1**

Submode  
**13**

Data No.  
**04**

PC Programming  
 + AN

## General Description

Use this Memory Block to assign the Outgoing Priority for the B-channels when calls are originated on a PRT(1)-U( ) ETU.

This assignment is allowed by handset programming and SAT.

## Display

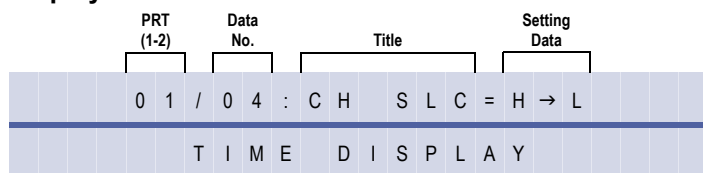





## Settings

LK 1	LK 2	LK 3	LK 4	LK 5	LK 6	LK 7	LK 8
H → L High to Low	L → H Low to High						

The shaded area indicates the default setting.

## Programming Procedures

- 1 Go off-line.
- 2 Press LK1+ LK13 +   to access the Memory Block.
- 3 Press the corresponding CO/PBX line key to change the data option.
- 4 Press  to write the data. The next Memory Block is displayed.
- 5 Program the next Memory Block or press  to go back on-line.

## Related Programming

M.B. Number	Memory Block Name
7-1	Card Interface Slot Assignment
1-13-00	PRI Channel Assignment

# N

This Memory Block applies to all firmware versions of the PRT(1)-U( ) ETU.

# PRT B Channel-to-Trunk Group Assignment

System Mode  
**1**

Submode  
**13**

Data No.  
**05**

PC Programming  
 + AN









## General Description

Use this Memory Block to assign a Trunk Group Number to each B channel or any Trunk Group for each B channel. Changing this assignment is not normally required and default should be set. This Memory Block could be used when different trunks are used in the same PRI span or for a tenant application where multiple tenants share the PRI span and separation of B channels is required.

## Display

PRT No.	Data No.	Title	Setting Data B-	Setting Data CO
0 1 /	0 5 :	B	0 1 = T G	0 0
T I M E D I S P L A Y				

## Programming Procedures

<b>1</b>	Go off-line.	
<b>2</b>	Press LK1 + LK13 +   to access the Memory Block.	
<b>3</b>	Use the following to enter data:  to move the cursor left.  to move the cursor right.  ~  to enter numeric data. (00~30, 00=Not Assigned) 00 is Any Trunk Group 01~32 are Trunk Groups 01~32	<b>Default Values</b> 00, Any Trunk Group
<b>4</b>	Press  to write the data and display the next B channel or next Memory Block.	
<b>5</b>	Program the next Memory Block or press  To go back on-line.	

## Related Programming

M.B. Number	Memory Block Name
<b>7-1</b>	Card Interface Slot Assignment
<b>1-13-00</b>	PRI Channel Assignment
<b>1-13-04</b>	PRT B Channel Outgoing Priority Selection
<b>3-03</b>	Trunk-to-Trunk Group Assignment
<b>3-91</b>	Trunk Type Selection

# N

1. This Memory Block must be coordinated with Memory Block 3-03 (Trunk-to-Trunk Group Assignment). The number of assigned channels must be the same or greater (including default) than the number of trunks to a trunk group assigned in Memory Block 3-03.  
For Example, When Memory Block 3-03 has five PRT trunks for Trunk Group 1, this Memory Block must have at least five B channels for Trunk Group 1.
2. This Memory Block applies only to PRT(1)-U( ) ETU firmware version 4.0 or higher.

**Data assignment for above example.**

Memory Block	Title	Setting Data
7-01	Card Interface Slot Assignment	Slot 4: PRT/PRT (lower/upper) Slot 5: None/None Slot 6: None/None
1-08-33	Master Clock Selection	Cabinet 1, Slot 4
1-13-00	PRT Channel Assignment	8 Channels
1-13-05	PRT B-Channel Map Assignment	B1~B4: 00 (Not Assigned) B5~B12 Assigned B13~B30: 00 (Not Assigned)

THIS PAGE INTENTIONALLY LEFT BLANK



# ACR Feature Allow/Deny Selection

## General Description

Use this Memory Block to specify whether or not ACR is system wide.

## Display

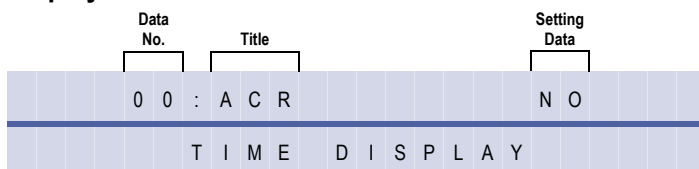

System Mode  
**1**

Submode  
**14**

Data No.  
**00**



PC Programming  
 + AO

## Settings

LK 1	LK 2	LK 3	LK 4
NO (Deny)	YES (Allow)		
LK 5	LK 6	LK 7	LK 8

The shaded selection is the default.

## Programming Procedures

- 1 Go off-line.
- 2 Press LK1 + LK14 to access the Memory Block.
- 3 Press the corresponding CO/PBX line key to change the Setting Data option.
- 4 Press  to write the data.
- 5 Press  to go back on-line.

## Related Programming

M.B. Number	Memory Block Name
<b>3-03</b>	Trunk-to-Trunk Group Assignment
<b>4-40</b>	LCR Class Selection
<b>1-8-08</b>	Class of Service (Station) Feature Selection 2
<b>1-14-01</b>	ACR Dialling Assignment
<b>1-14-01</b>	ACR Dialed Number Dial Allow/Deny Selection
<b>1-14-03</b>	ACR Trunk Group to Route Number Assignment
<b>1-14-05</b>	ACR Digit Add Assignment
<b>1-14-02</b>	ACR Route Table Number Assignment
<b>1-14-04</b>	ACR Digit Delete Assignment

\*When ACR is set to Allow in this MB, LCR stored on the MIF-L will stop functioning.

# ACR Dialling Assignment

*System Mode*  
**1**  
*Submode*  
**14**  
*Data No.*  
**01**  
*PC Programming*  
 + AO



## General Description

Use this Memory Block to assign a dialling plan to one of four possible ACR Tables. Each table contains 128 maximum dialling assignments for the selected dialling plan.

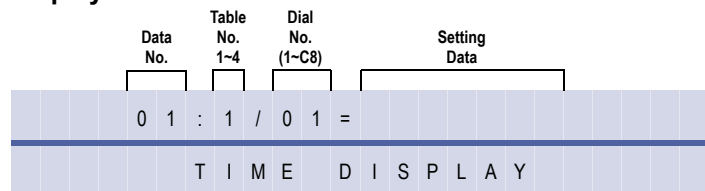
## Display



## Programming Procedures

- 1 Go off-line.
- 2 Press LK1 + LK14 +   to access the Memory Block.
- 3 Use dial pad keys to select Table number
 

**Default Values:**  
None







**Note:** Use  to move cursor left.  
 Use  to move cursor right.  
 Use  to clear setting data.

Table No      1~4  
 Entry No.    01~C8 (1~128) per table  
 Setting Data  0~9, , , \*, #, X, P, N (8 Digit Maximum)
- 4 Operation Data Includes:
 

Operation Data	Dial	Operation
X	0~9, *, #	Redial + 7
P	0 and 1	Redial + 8
N	2~9	Redial + 9
*	*	Redial + *
#	#	Redial + #
- 5 Press  to write the data.
- 6 Press  to go back on-line.

**Related Programming**

M.B. Number	Memory Block Name
<b>3-03</b>	Trunk-to-Trunk Group Assignment
<b>4-40</b>	LCR Class Selection
<b>1-8-08</b>	Class of Service (Station) Feature Selection 2
<b>1-14-00</b>	ACR Feature Allow/Deny Selection
<b>1-14-01</b>	ACR Dialed Number Dial Allow/Deny Selection
<b>1-14-03</b>	ACR Trunk Group to Route Number Assignment
<b>1-14-05</b>	ACR Digit Add Assignment
<b>1-14-02</b>	ACR Route Table Number Assignment
<b>1-14-04</b>	ACR Digit Delete Assignment

**N**

Entries A0~C8 are 100~128.

# ACR Dialed Number Dial Allow/Deny Selection

System Mode  
**1**

Submode  
**14**

Data No.  
**02**

PC Programming  
 + AO

## General Description

Use this Memory Block to Allow or Deny digits that are entered in the ACR dialling assignment to be routed using the ACR feature.

## Display

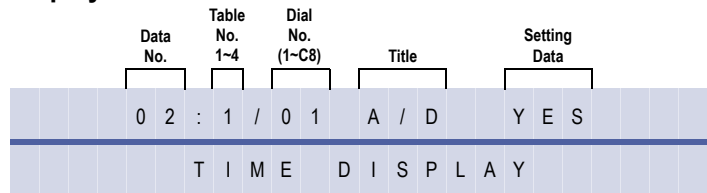









## Settings

LK 1	LK 2	LK 3	LK 4
YES	NO		
LK 5	LK 6	LK 7	LK 8

The shaded selection is the default.

## Programming Procedures

- 1 Go off-line.
- 2 Press LK1 + LK14 +   to access the Memory Block.
- 3 Press the corresponding CO/PBX line key to change the Setting Data option.  
Use dial pad keys  ~  to select Data  
**Note:** Press  to move cursor left.  
Press  to move cursor right.
- 4 Press  to write the data.
- 5 Press  to go back on-line.

**Related Programming**

M.B. Number	Memory Block Name
3-03	Trunk-to-Trunk Group Assignment
4-40	LCR Class Selection
1-8-08	Class of Service (Station) Feature Selection 2
1-14-00	ACR Feature Allow/Deny Selection
1-14-01	ACR Dialling Assignment
1-14-03	ACR Trunk Group to Route Number Assignment
1-14-05	ACR Digit Add Assignment
1-14-02	ACR Route Table Number Assignment
1-14-04	ACR Digit Delete Assignment

**N**

1. Entries A0~C8 are 100~128.
2. If NO (Deny) is set, programming the other Memory Blocks for this dialling assignment is unnecessary.

# ACR Route Table Number Assignment

System Mode  
**1**

Submode  
**14**

Data No.  
**03**

PC Programming  
 + **AO**









## General Description

Use this Memory Block to assign each ACR Dialling Assignment to an ACR Route Assignment.

## Display

Data No.	Table 1-4	01-C8 Dial No.	Title	Setting Data
03	1	01	ROUTE	00
T I M E D I S P L A Y				

## Programming Procedures

1	Go off-line.
2	Press LK1 + LK14 +   to access the Memory Block.
3	Use dial pad keys to select Table number (1~4), Dial number (01~C8), and Route number (01~32). Use dial pad keys  ~  to select Data <b>Note:</b> Use  to move cursor left. Use  to move cursor right.
4	Press  to write the data.
5	Press  to go back on-line.

## Related Programming

M.B. Number	Memory Block Name
3-03	Trunk-to-Trunk Group Assignment
4-40	LCR Class Selection
1-8-08	Class of Service (Station) Feature Selection 2
1-14-00	ACR Feature Allow/Deny Selection
1-14-01	ACR Dialling Assignment
1-14-01	ACR Dialed Number Dial Allow/Deny Selection
1-14-03	ACR Trunk Group to Route Number Assignment
1-14-05	ACR Digit Add Assignment
1-14-04	ACR Digit Delete Assignment



1. Entries A0~C8 are 100~128.
2. If ACR Route Assignment 00 is selected, the call is sent to Trunk Group 01 exactly as it was dialled.

# ACR Trunk Group to Route Number Assignment

## General Description

Use this Memory Block to specify whether a Trunk Group is used for each Route assignment.

## Display

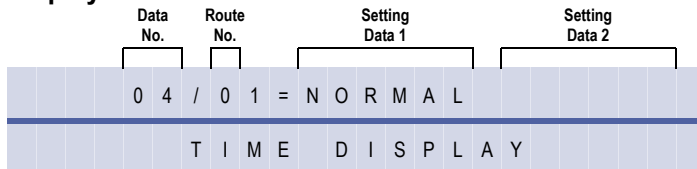

System Mode  
**1**

Submode  
**14**

Data No.  
**04**

PC Programming  
 + AB

LK 1	LK 2	LK 3	LK 4	LK 5	LK 6	LK 7	LK 8
NORMAL (Originate)	TKGP (01~32)			RAB (01~32)	ICM		

The shaded selection is the default.

## Programming Procedures

- 1 Go off-line.
- 2 Press LK1 + LK14 + to access the Memory Block.
- 3 Press the corresponding CO/PBX line key to change the Setting Data 1 option.  
Use dial pad keys ~ to select Data Setting Data 2 Trunk Group Number (01~32) or Setting Data 2 RAB (1~16).  
**Note:** Press to move cursor left.  
Press to move cursor right.
- 4 Press to write the data.
- 5 Press to go back on-line.

## Related Programming

M.B. Number	Memory Block Name
<b>3-03</b>	Trunk-to-Trunk Group Assignment
<b>4-40</b>	LCR Class Selection
<b>1-8-08</b>	Class of Service (Station) Feature Selection 2
<b>1-14-00</b>	ACR Feature Allow/Deny Selection
<b>1-14-01</b>	ACR Dialling Assignment
<b>1-14-02</b>	ACR Dialed Number Dial Allow/Deny Selection
<b>1-14-03</b>	ACR Route Table Number Assignment
<b>1-14-05</b>	ACR Digit Delete Assignment
<b>1-14-06</b>	ACR Digit Add Assignment



If NORMAL is selected, the call is routed to Trunk Group 1 exactly as dialled.

# ACR Digit Delete Assignment

## General Description

Use this Memory Block to specify the number of digits to be deleted from the Route assignment.

## Display

Data No.	Title	Route No.	Setting Data
05	DELETE	01	= 00
TIME DISPLAY			









System Mode  
**1**

Submode  
**14**

Data No.  
**05**

PC Programming  
 + AO

## Programming Procedures

1	Go off-line.
2	Press LK1 + LK14 +   to access the Memory Block.
3	Use dial pad keys  ~  to select Route No (01~32). and number of digits (00~10). <b>Note:</b> Use  to move cursor left. Use  to move cursor right. If setting data is 00, digits are not deleted.
4	Press  to write the data.
5	Press  to go back on-line.

## Related Programming

M.B. Number	Memory Block Name
<b>3-03</b>	Trunk-to-Trunk Group Assignment
<b>4-40</b>	LCR Class Selection
<b>1-8-08</b>	Class of Service (Station) Feature Selection 2
<b>1-14-00</b>	ACR Feature Allow/Deny Selection
<b>1-14-01</b>	ACR Dialling Assignment
<b>1-14-01</b>	ACR Dialed Number Dial Allow/Deny Selection
<b>1-14-02</b>	ACR Route Table Number Assignment
<b>1-14-05</b>	ACR Digit Add Assignment
<b>1-14-03</b>	ACR Trunk Group to Route Number Assignment



The maximum number of digits that can be deleted cannot exceed the number of digits used to route the call.



# ACR Digit Add Assignment

## General Description

Use this Memory Block to specify the number of digits to add to the Route assignment.

## Display

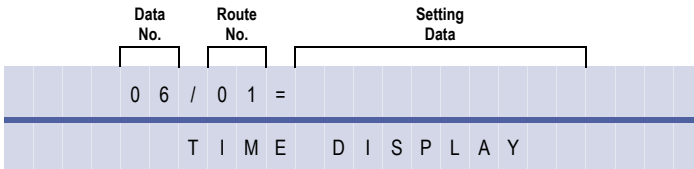



















System Mode  
**1**

Submode  
**14**

Data No.  
**06**

PC Programming  
 + AO

## Programming Procedures

1	Go off-line.
2	Press LK1 + LK14 +   to access the Memory Block.
3	Use dial pad keys  ~  ,  ,  to select Route No. (01~32) and enter the additional dialling digits. <b>Default Values</b> Not Specified <b>Note:</b> Use  to move cursor left. Use  to move cursor right. Use  +  to enter  . Use  +  to enter  . Use  +  to enter PAUSE.
4	Press  to write the data.
5	Press  to go back on-line.

## Related Programming

M.B. Number	Memory Block Name
3-03	Trunk-to-Trunk Group Assignment
4-40	LCR Class Selection
1-8-08	Class of Service (Station) Feature Selection 2
1-14-00	ACR Feature Allow/Deny Selection
1-14-01	ACR Dialling Assignment
1-14-01	ACR Dialed Number Dial Allow/Deny Selection
1-14-02	ACR Route Table Number Assignment
1-14-04	ACR Digit Delete Assignment
1-14-03	ACR Trunk Group to Route Number Assignment

# N

A maximum of 10 digits can be added to a route assignment.

# ACR Max Digit Assignment

*System Mode*  
**1**

*Submode*  
**14**

*Data No.*  
**07**

*PC Programming*  
 + **AM**

## General Description









Use this Memory Block to specify the number of digits to be collected by the system before the message is sent to the network.

**System Software R2000 or higher is required.**

## Display

Data No.	Title	Route 01-32	Setting Data
07	MAXDGT	01	= 24
TIME DISPLAY			

## Programming Procedures

<b>1</b>	Go off-line.	
<b>2</b>	Press LK1 + LK14 +   to access the Memory Block.	
<b>3</b>	Use dial pad keys to enter Setting Data. <i>Note:</i> Use the following to enter data:  to move cursor left.  to move cursor right.  ~  to enter data	<p><b>Default Values</b>                      Length = 24 Digits                      Valid range for setting data: 01~99</p>
<b>4</b>	Press  to write the data.	
<b>5</b>	Press  to go back on-line.	

## Related Programming

M.B. Number	Memory Block Name
<b>3-03</b>	Trunk-to-Trunk Group Assignment
<b>4-40</b>	LCR Class Selection
<b>1-1-30</b>	Route Advance Block Assignment
<b>1-8-08</b>	Class of Service (Station) Feature Selection 2
<b>1-14-00</b>	ACR Allow/Deny Selection
<b>1-14-01</b>	ACR Dialling Assignment
<b>1-14-02</b>	ACR Dial Allow/Deny Selection
<b>1-14-03</b>	ACR Route Table Number Assignment
<b>1-14-04</b>	ACR Trunk Group to Route Number Assignment
<b>1-14-05</b>	ACR Digit Delete Assignment
<b>1-14-06</b>	ACR Digit Add Assignment



1. When 00 is set for this Memory Block, refer to Memory Block 1-1-81 (ISDN / K-CCIS Interval Time Selection) for the time it takes before the message is sent to the K-CCIS Network.
2. ARS Max Digit Assignment applies to K-CCIS Trunk Routes routed through Automatic Route Selection.

# K-CCIS Main/Remote Office Selection

## General Description

Use this Memory Block to activate K-CCIS by assigning a Main or Remote system.

Applicable for IPK R2000 and above.

## Display

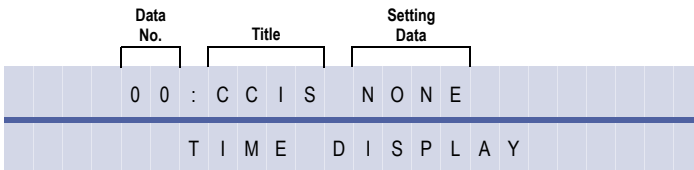

## Settings

LK1	LK2	LK3	LK4	LK5	LK6	LK7	LK8
NONE	MAIN	REMOTE					

The shaded area indicates the default setting.

## Programming Procedures

1	Go off-line.
2	Press LK1 + LK15 to access the Memory Block.
3	Press the corresponding CO/PBX line key to change the Setting Data option.
4	Press  to write the data.
5	Press  to go back on-line.

## Related Programming

M.B. Number	Memory Block Name
7-1	Card Interface Slot Assignment
7-3-01	MIF (LCR) Assignment
7-3-02	MIF (SMDR) Assignment
1-15-02	Common Signal Channel Assignment
1-15-03	Originating Point Code Assignment
1-15-04	Destination Point Code Assignment
1-15-05	Destination Point Code Transfer Assignment
1-15-06	Originating Office Code Number Assignment
1-15-07	K-CCIS Message Response Timeout Assignment
1-15-08	Link Reconnect Allow/Deny Selection
1-15-09	K-CCIS Maximum Call Forwarding Hop Assignment
1-15-10	Calling Name Display Allow/Deny Selection
1-15-11	Centralised Billing Allow/Deny Selection
1-15-12	Centralised Billing – Point Code of Center Office Assignment

System Mode  
**1**

Submode  
**15**

Data No.  
**00**

PC Programming  
 + **AW**

**Related Programming (Continued)**

M.B. Number	Memory Block Name
1-15-13	Centralised Day/Night Switching for Remote Office Assignment
1-15-14	Centralised Day/Night Switching for Main Office Assignment
1-15-15	Centralised BLF Send Point Code Assignment
1-15-16	Centralised BLF Send Extension Number Assignment
1-15-17	Centralised BLF Send Time Assignment
1-15-18	Centralised BLF Display Extension Number Assignment
3-70	CIC Number Assignment
5-05	Common Signalling Channel Route Selection
1-1-05	Start Time Selection
1-5-02	SMDR Print Format
1-5-13	Printer Connected Selection
1-5-14	Printer Line Feed Control Selection
1-5-25	SMDR Valid Call Time Assignment
1-5-26	SMDR Incoming/Outgoing Print Selection
1-8-35	COM Port Baud Rate Setting Assignment
4-56	SMDR Telephone Print Selection

**N**

1. For Xen IPK to Xen IPK Network only one system can be set for Main. All other systems must be set from Remote.
2. When connected to a PBX, the Xen IPK must be set for REMOTE in this Memory Block.
3. When this Memory Block is set to NONE, K-CCIS does not function even when all other K-CCIS Memory Blocks are allowed.
4. The Main or Remote setting only applies to the Centralised Day/Night Mode Change - K-CCIS feature and only when using traditional K-CCIS with point-to-point T1 lines.  
This Memory Block is not used and has no effect on the IP (K-CCIS) feature.

# Common Signal Channel Assignment

## General Description

Use this Memory Block to assign a T1 Trunk to be a Common Signalling Channel.

Applicable for IPK R2000 and above.

## Display

Data No.	Title	C-Channel 1-4	Setting Data
02	C S C	1	= C O 0 0
T I M E D I S P L A Y			

System Mode  
**1**









Submode  
**15**

Data No.  
**02**

PC Programming

 + AW

## Programming Procedures

1	Go off-line.	
2	Press LK1 + LK15 +   to access the Memory Block.	
3	Use dial pad keys to select Table number <b>Note:</b> Use the following pad keys to enter Setting Data:  to move cursor left.  to move cursor right.  ~  to enter numeric data.	<b>Default Values:</b> 00
4	Press  to write the data.	
5	Press  to go back on-line.	

## Related Programming

M.B. Number	Memory Block Name
7-1	Card Interface Slot Assignment
7-3-01	MIF (LCR) Assignment
7-3-02	MIF (SMDR) Assignment
1-15-00	K-CCIS Main/Remote Office Selection
1-15-03	Originating Point Code Assignment
1-15-04	Destination Point Code Assignment
1-15-05	Destination Point Code Transfer Assignment
1-15-06	Originating Office Code Number Assignment
1-15-07	K-CCIS Message Response Timeout Assignment
1-15-08	Link Reconnect Allow/Deny Selection
1-15-09	K-CCIS Maximum Call Forwarding Hop Assignment
1-15-10	Calling Name Display Allow/Deny Selection
1-15-11	Centralised Billing Allow/Deny Selection

**Related Programming (Continued)**

M.B. Number	Memory Block Name
1-15-12	Centralised Billing – Point Code of Center Office Assignment
1-15-13	Centralised Day/Night Switching for Remote Office Assignment
1-15-14	Centralised Day/Night Switching for Main Office Assignment
1-15-15	Centralised BLF Send Point Code Assignment
1-15-16	Centralised BLF Send Extension Number Assignment
1-15-17	Centralised BLF Send Time Assignment
1-15-18	Centralised BLF Display Extension Number Assignment
3-70	CIC Number Assignment
5-05	Common Signalling Channel Route Selection
1-1-05	Start Time Selection
1-5-02	SMDR Print Format
1-5-13	Printer Connected Selection
1-5-14	Printer Line Feed Control Selection
1-5-25	SMDR Valid Call Time Assignment
1-5-26	SMDR Incoming/Outgoing Print Selection
1-8-35	COM Port Baud Rate Setting Assignment
4-56	SMDR Telephone Print Selection

**N**

Any DTI Trunk can be assigned as the C-Channel for K-CCIS connection.

# Originating Point Code Assignment

## General Description

Use this Memory Block to assign the originating point code for each Common Signalling Channel.

Applicable for IPK R2000 and above.

## Display

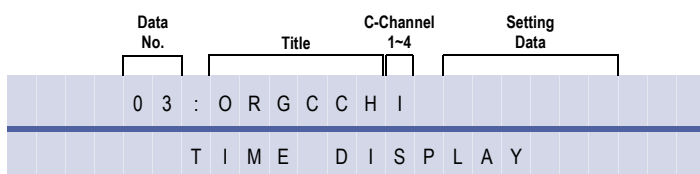









System Mode  
**1**

Submode  
**15**

Data No.  
**03**

PC Programming  
 + **AW**

## Programming Procedures

1	Go off-line.	
2	Press LK1 + LK15 +   to access the Memory Block.	
3	Use dial pad keys to enter Setting Data <b>Note:</b> Use the following pad keys to enter Setting Data:  to move cursor left.  to move cursor right.  ~  to enter numeric data. <b>Note:</b> Point Code Range is 00001~16367	<b>Default Values:</b> Blank
4	Press  to write the data.	
5	Press  to go back on-line.	

## Related Programming

M.B. Number	Memory Block Name
7-1	Card Interface Slot Assignment
7-3-01	MIF (LCR) Assignment
7-3-02	MIF (SMDR) Assignment
1-15-00	K-CCIS Main/Remote Office Selection
1-15-02	Common Signal Channel Assignment
1-15-04	Destination Point Code Assignment
1-15-05	Destination Point Code Transfer Assignment
1-15-06	Originating Office Code Number Assignment
1-15-07	K-CCIS Message Response Timeout Assignment
1-15-08	Link Reconnect Allow/Deny Selection
1-15-09	K-CCIS Maximum Call Forwarding Hop Assignment
1-15-10	Calling Name Display Allow/Deny Selection

**Related Programming (Continued)**

M.B. Number	Memory Block Name
1-15-11	Centralised Billing Allow/Deny Selection
1-15-12	Centralised Billing – Point Code of Center Office Assignment
1-15-13	Centralised Day/Night Switching for Remote Office Assignment
1-15-14	Centralised Day/Night Switching for Main Office Assignment
1-15-15	Centralised BLF Send Point Code Assignment
1-15-16	Centralised BLF Send Extension Number Assignment
1-15-17	Centralised BLF Send Time Assignment
1-15-18	Centralised BLF Display Extension Number Assignment
3-70	CIC Number Assignment
5-05	Common Signalling Channel Route Selection
1-1-05	Start Time Selection
1-5-02	SMDR Print Format
1-5-13	Printer Connected Selection
1-5-14	Printer Line Feed Control Selection
1-5-25	SMDR Valid Call Time Assignment
1-5-26	SMDR Incoming/Outgoing Print Selection
1-8-35	COM Port Baud Rate Setting Assignment
4-56	SMDR Telephone Print Selection

**N**

1. Each C-Channel used must have an Originating Point Code assigned.
2. When more than one C-Channel is used, the same point code is used for each C-Channel.



# Destination Point Code Assignment

## General Description

Use this Memory Block to assign the Destination Point Code for each Common Signalling Channel.

Applicable for IPK R2000 and above.

## Display

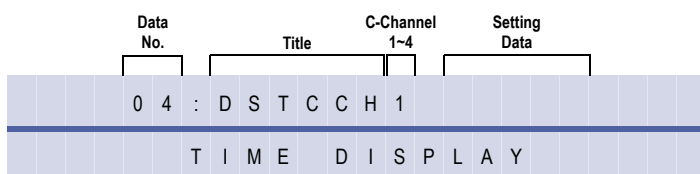

System Mode  
1

Submode  
15

Data No.  
04

PC Programming

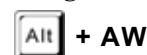

## Programming Procedures

1	Go off-line.	
2	Press LK1 + LK15 +   to access the Memory Block.	
3	Use dial pad keys to enter Setting Data. <b>Note:</b> Use the following pad keys to enter Setting Data: to move cursor left. to move cursor right. ~  to enter numeric data. <b>Note:</b> Point Code Range is 00001~16367	<b>Default Values:</b> Blank
4	Press  to write the data.	
5	Press  to go back on-line.	

## Related Programming

M.B. Number	Memory Block Name
7-1	Card Interface Slot Assignment
7-3-01	MIF (LCR) Assignment
7-3-02	MIF (SMDR) Assignment
1-15-00	K-CCIS Main/Remote Office Selection
1-15-02	Common Signal Channel Assignment
1-15-03	Originating Point Code Assignment
1-15-05	Destination Point Code Transfer Assignment
1-15-06	Originating Office Code Number Assignment
1-15-07	K-CCIS Message Response Timeout Assignment
1-15-08	Link Reconnect Allow/Deny Selection
1-15-09	K-CCIS Maximum Call Forwarding Hop Assignment
1-15-10	Calling Name Display Allow/Deny Selection

**Related Programming (Continued)**

M.B. Number	Memory Block Name
1-15-11	Centralised Billing Allow/Deny Selection
1-15-12	Centralised Billing – Point Code of Center Office Assignment
1-15-13	Centralised Day/Night Switching for Remote Office Assignment
1-15-14	Centralised Day/Night Switching for Main Office Assignment
1-15-15	Centralised BLF Send Point Code Assignment
1-15-16	Centralised BLF Send Extension Number Assignment
1-15-17	Centralised BLF Send Time Assignment
1-15-18	Centralised BLF Display Extension Number Assignment
3-70	CIC Number Assignment
5-05	Common Signalling Channel Route Selection
1-1-05	Start Time Selection
1-5-02	SMDR Print Format
1-5-13	Printer Connected Selection
1-5-14	Printer Line Feed Control Selection
1-5-25	SMDR Valid Call Time Assignment
1-5-26	SMDR Incoming/Outgoing Print Selection
1-8-35	COM Port Baud Rate Setting Assignment
4-56	SMDR Telephone Print Selection

**N**

Each C-Channel used must have a Destination Point Code assigned.

# Destination Point Code Transfer Assignment

## General Description

Use this Memory Block to assign the Destination Point Code to the associated Common Signalling Channel when K-CCIS commands are required to pass through a tandem system. This Memory Block is used for Centralised K-CCIS features.

With **System Software R2000 or higher**, a CCH Channel *i* can be assigned for K-CCIS over IP.

System Mode  
**1**

Submode  
**15**







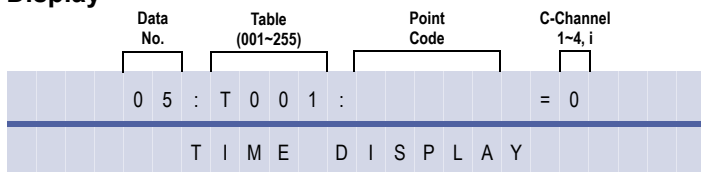

Data No.  
**05**

PC Programming  
 + **AW**

## Display



## Programming Procedures

<b>1</b>	Go off-line.		
<b>2</b>	Press LK1 + LK15 +   to access the Memory Block.		
<b>3</b>	Use dial pad keys to enter Setting Data. <b>Note:</b> Use the following to enter data:  to move cursor left.  to move cursor right.  ~  to enter numeric data. <b>Note:</b> Point Code Range is 00001~16367 T001~T255 can be assigned.	<b>Default Values:</b> Blank	
<b>4</b>	Press  to write the data.		
<b>5</b>	Press  to go back on-line.		

Xen 100 is Master for Centralised Day/Night Mode Change (K-CCIS)

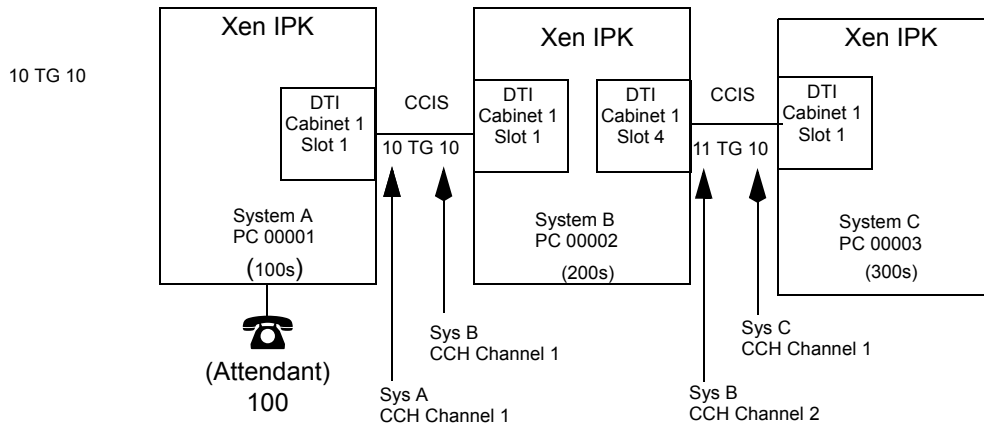

System A (100s)	System B (200s)	System C (300s)
MB 1-15-03 CCH1 = PC 00001	MB 1-15-03 CCH1 = PC 00002	MB 1-15-03 CCH1 = PC 00003
MB 1-15-04 CCH1 = PC 00002	MB 1-15-04 CCH1 = PC 00001	MB 1-15-04 CCH1 = PC 00002
	MB 1-15-04 CCH2 = PC 00003	
MB 1-15-05 Not assigned	MB 1-15-05 PC 00003 = CCH2	MB 1-15-05 Not assigned

**Related Programming**

M.B. Number	Memory Block Name
7-1	Card Interface Slot Assignment
7-3-01	MIF (LCR) Assignment
7-3-02	MIF (SMDR) Assignment
1-15-00	K-CCIS Main/Remote Office Selection
1-15-01	Common Signal Channel Data Speed Assignment
1-15-02	Common Signal Channel Assignment
1-15-03	Originating Point Code Assignment
1-15-04	Destination Point Code Assignment
1-15-06	Originating Office Code Number Assignment
1-15-07	K-CCIS Message Response Timeout Assignment
1-15-08	Link Reconnect Allow/Deny Selection
1-15-09	K-CCIS Maximum Call Forwarding Hop Assignment
1-15-10	Calling Name Display Allow/Deny Selection
1-15-11	Centralised Billing Allow/Deny Selection
1-15-12	Centralised Billing – Point Code of Center Office Assignment
1-15-13	Centralised Day/Night Switching for Remote Office Assignment
1-15-14	Centralised Day/Night Switching for Main Office Assignment
1-15-15	Centralised BLF Send Point Code Assignment
1-15-16	Centralised BLF Send Extension Number Assignment

Doc. No.: 8194 - Release 2.0  
December 2004

**Related Programming (Continued)**

M.B. Number	Memory Block Name
1-15-17	Centralised BLF Send Time Assignment
1-15-18	Centralised BLF Display Extension Number Assignment
3-70	CIC Number Assignment
5-05	Common Signalling Channel Route Selection
1-1-05	Start Time Selection
1-5-02	SMDR Print Format
1-5-13	Printer Connected Selection
1-5-14	Printer Line Feed Control Selection
1-5-25	SMDR Valid Call Time Assignment
1-5-26	SMDR Incoming/Outgoing Print Selection
1-8-35	COM Port Baud Rate Setting Assignment
4-56	SMDR Telephone Print Selection

**N**

1. This Memory Block is required for the following K-CCIS features:
  - Centralised Billing - K-CCIS
  - Centralised Day/Night Mode Change - K-CCIS
  - Centralised BLF (K-CCIS)
2. Assigning a CCH i channel is used for IP (K-CCIS) feature.

# Originating Office Code Number Assignment

## General Description

Use this Memory Block to assign the Office Code to the system when Open Numbering Plan is used.

Applicable for IPK R2000 and above.

## Display

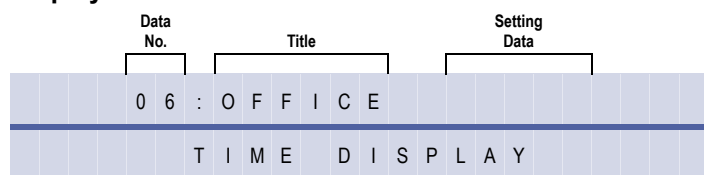

System Mode  
**1**

Submode  
**15**

Data No.  
**06**

PC Programming  
 + AW

## Programming Procedures

1	Go off-line.	
2	Press LK1 + LK15 +   to access the Memory Block.	
3	Use dial pad keys to enter Setting Data. <b>Note:</b> Use the following to enter data: to move cursor left. to move cursor right. to enter numeric data. <b>Note:</b> The Maximum Office Code Number can have four digits and should include the Access Code for the open numbering plan. Valid range is 0~9999.	<b>Default Values:</b> Blank
4	Press  to write the data.	
5	Press  to go back on-line.	

## Related Programming

M.B. Number	Memory Block Name
7-1	Card Interface Slot Assignment
7-3-01	MIF (LCR) Assignment
7-3-02	MIF (SMDR) Assignment
1-15-00	K-CCIS Main/Remote Office Selection
1-15-02	Common Signal Channel Assignment
1-15-03	Originating Point Code Assignment
1-15-04	Destination Point Code Assignment
1-15-05	Destination Point Code Transfer Assignment
1-15-07	K-CCIS Message Response Timeout Assignment
1-15-08	Link Reconnect Allow/Deny Selection
1-15-09	K-CCIS Maximum Call Forwarding Hop Assignment
1-15-10	Calling Name Display Allow/Deny Selection

Doc. No.: 8194 - Release 2.0  
December 2004

**Related Programming (Continued)**

M.B. Number	Memory Block Name
1-15-11	Centralised Billing Allow/Deny Selection
1-15-12	Centralised Billing – Point Code of Center Office Assignment
1-15-13	Centralised Day/Night Switching for Remote Office Assignment
1-15-14	Centralised Day/Night Switching for Main Office Assignment
1-15-15	Centralised BLF Send Point Code Assignment
1-15-16	Centralised BLF Send Extension Number Assignment
1-15-17	Centralised BLF Send Time Assignment
1-15-18	Centralised BLF Display Extension Number Assignment
3-70	CIC Number Assignment
5-05	Common Signalling Channel Route Selection
1-1-05	Start Time Selection
1-5-02	SMDR Print Format
1-5-13	Printer Connected Selection
1-5-14	Printer Line Feed Control Selection
1-5-25	SMDR Valid Call Time Assignment
1-5-26	SMDR Incoming/Outgoing Print Selection
1-8-35	COM Port Baud Rate Setting Assignment
4-56	SMDR Telephone Print Selection

**N**

The maximum number of digits that can be deleted cannot exceed the number of digits used to route the call.

# K-CCIS Message Response Timeout Assignment

System Mode  
**1**

Submode  
**15**

Data No.  
**07**

PC Programming  
 + AW

## General Description









Use this Memory Block to assign the time before a call or message request is cancelled when no response is received from the destination office.

Applicable for IPK R2000 and above.

## Display

Data No.	Title	Setting Data
07	RES TIME	30 s
TIME DISPLAY		

## Programming Procedures

1	Go off-line.	
2	Press LK1 + LK15 +   to access the Memory Block.	
3	Use dial pad keys to enter Setting Data. <b>Note:</b> Use the following to enter data:  to move cursor left.  to move cursor right.  ~  to enter numeric data. <b>Note:</b> Setting Data: 00 = ∞ (infinity) 01~99 Seconds are valid times.	<b>Default Values:</b> 30 Seconds
4	Press  to write the data.	
5	Press  to go back on-line.	

## Related Programming

M.B. Number	Memory Block Name
7-1	Card Interface Slot Assignment
7-3-01	MIF (LCR) Assignment
7-3-02	MIF (SMDR) Assignment
1-15-00	K-CCIS Main/Remote Office Selection
1-15-02	Common Signal Channel Assignment
1-15-03	Originating Point Code Assignment
1-15-04	Destination Point Code Assignment
1-15-05	Destination Point Code Transfer Assignment
1-15-06	Originating Office Code Number Assignment
1-15-08	Link Reconnect Allow/Deny Selection
1-15-09	K-CCIS Maximum Call Forwarding Hop Assignment



**Related Programming (Continued)**

M.B. Number	Memory Block Name
1-15-10	Calling Name Display Allow/Deny Selection
1-15-11	Centralised Billing Allow/Deny Selection
1-15-12	Centralised Billing – Point Code of Center Office Assignment
1-15-13	Centralised Day/Night Switching for Remote Office Assignment
1-15-14	Centralised Day/Night Switching for Main Office Assignment
1-15-15	Centralised BLF Send Point Code Assignment
1-15-16	Centralised BLF Send Extension Number Assignment
1-15-17	Centralised BLF Send Time Assignment
1-15-18	Centralised BLF Display Extension Number Assignment
3-70	CIC Number Assignment
5-05	Common Signalling Channel Route Selection
1-1-05	Start Time Selection
1-5-02	SMDR Print Format
1-5-13	Printer Connected Selection
1-5-14	Printer Line Feed Control Selection
1-5-25	SMDR Valid Call Time Assignment
1-5-26	SMDR Incoming/Outgoing Print Selection
1-8-35	COM Port Baud Rate Setting Assignment
4-56	SMDR Telephone Print Selection

**N**

When a response from the distant system is not received in the specified time, the system cancels the call. The user hears Reorder Tone and CONGESTION is displayed.

# Link Reconnect Allow/Deny Selection

## General Description

Use this Memory Block to specify the number of digits to be collected by the system before the message is sent to the network.

Applicable for IPK R2000 and above.

## Display

Data No.	Title	Route 01-32	Setting Data
08	MAXDGT	01	= 24
T I M E D I S P L A Y			

System Mode  
**1**

Submode  
**15**

Data No.  
**08**





PC Programming  
 + AW

## Settings

LK1	LK2	LK3	LK4	LK5	LK6	LK7	LK8
NO (Deny)	YES (Allow)						

The shaded area indicates the default setting.

## Programming Procedures

- 1 Go off-line.
- 2 Press LK1 + LK15 +   to access the Memory Block.
- 3 Press the corresponding CO/PBX line key to change the option.
- 4 Press  to write the data.
- 5 Press  to go back on-line.

## Related Programming

M.B. Number	Memory Block Name
7-1	Card Interface Slot Assignment
7-3-01	MIF (LCR) Assignment
7-3-02	MIF (SMDR) Assignment
1-15-00	K-CCIS Main/Remote Office Selection
1-15-02	Common Signal Channel Assignment
1-15-03	Originating Point Code Assignment
1-15-04	Destination Point Code Assignment
1-15-05	Destination Point Code Transfer Assignment
1-15-06	Originating Office Code Number Assignment
1-15-07	K-CCIS Message Response Timeout Assignment
1-15-09	K-CCIS Maximum Call Forwarding Hop Assignment
1-15-10	Calling Name Display Allow/Deny Selection

**Related Programming (Continued)**

M.B. Number	Memory Block Name
1-15-11	Centralised Billing Allow/Deny Selection
1-15-12	Centralised Billing – Point Code of Center Office Assignment
1-15-13	Centralised Day/Night Switching for Remote Office Assignment
1-15-14	Centralised Day/Night Switching for Main Office Assignment
1-15-15	Centralised BLF Send Point Code Assignment
1-15-16	Centralised BLF Send Extension Number Assignment
1-15-17	Centralised BLF Send Time Assignment
1-15-18	Centralised BLF Display Extension Number Assignment
3-70	CIC Number Assignment
5-05	Common Signalling Channel Route Selection
1-1-05	Start Time Selection
1-5-02	SMDR Print Format
1-5-13	Printer Connected Selection
1-5-14	Printer Line Feed Control Selection
1-5-25	SMDR Valid Call Time Assignment
1-5-26	SMDR Incoming/Outgoing Print Selection
1-8-35	COM Port Baud Rate Setting Assignment
4-56	SMDR Telephone Print Selection

**N**

1. When NO is selected, Link Reconnect does not take place.
2. When Local Loop Start Trunks are used, and a disconnect signal is not received from the network, the time set in Memory Block 1-1-05 (Start Time Selection) applies for the reconnect to take place.

# K-CCIS Maximum Call Forwarding Hop Assignment

*System Mode*  
**1**

*Submode*  
**15**

*Data No.*  
**09**

*PC Programming*  
 + **AW**

## General Description









Use this Memory Block to specify the maximum number of multiple Call Forwarding hops over the K-CCIS network.

Applicable for IPK R2000 and above.

## Display

	Data No.		Title		Setting Data															
	09	:	CCIS	MAX	TRF	5														
	T I M E D I S P L A Y																			

## Programming Procedures

<b>1</b>	Go off-line.		
<b>2</b>	Press LK1 + LK15 +   to access the Memory Block.		
<b>3</b>	Use dial pad keys to enter Setting Data. <b>Note:</b> Use the following to enter data:  to move cursor left.  to move cursor right.  ~  to enter numeric data.	<b>Default Values:</b> 5 Range: 1~7	
<b>4</b>	Press  to write the data.		
<b>5</b>	Press  to go back on-line.		

## Related Programming

M.B. Number	Memory Block Name
<b>7-1</b>	Card Interface Slot Assignment
<b>7-3-01</b>	MIF (LCR) Assignment
<b>7-3-02</b>	MIF (SMDR) Assignment
<b>1-15-01</b>	Common Signal Channel Data Speed Assignment
<b>1-15-02</b>	Common Signal Channel Assignment
<b>1-15-03</b>	Originating Point Code Assignment
<b>1-15-04</b>	Destination Point Code Assignment
<b>1-15-05</b>	Destination Point Code Transfer Assignment
<b>1-15-06</b>	Originating Office Code Number Assignment
<b>1-15-07</b>	K-CCIS Message Response Timeout Assignment
<b>1-15-08</b>	Link Reconnect Allow/Deny Selection
<b>1-15-10</b>	Calling Name Display Allow/Deny Selection
<b>1-15-11</b>	Centralised Billing Allow/Deny Selection

Doc. No.: 8194 - Release 2.0  
December 2004

**Related Programming (Continued)**

M.B. Number	Memory Block Name
1-15-12	Centralised Billing – Point Code of Center Office Assignment
1-15-13	Centralised Day/Night Switching for Remote Office Assignment
1-15-14	Centralised Day/Night Switching for Main Office Assignment
1-15-15	Centralised BLF Send Point Code Assignment
1-15-16	Centralised BLF Send Extension Number Assignment
1-15-17	Centralised BLF Send Time Assignment
1-15-18	Centralised BLF Display Extension Number Assignment
3-70	CIC Number Assignment
5-05	Common Signalling Channel Route Selection
1-1-05	Start Time Selection
1-5-02	SMDR Print Format
1-5-13	Printer Connected Selection
1-5-14	Printer Line Feed Control Selection
1-5-25	SMDR Valid Call Time Assignment
1-5-26	SMDR Incoming/Outgoing Print Selection
1-8-35	COM Port Baud Rate Setting Assignment
4-56	SMDR Telephone Print Selection

**N**

This Memory Block applies to both traditional K-CCIS and IP (K-CCIS).

# Calling Name Display Allow/ Deny Selection

## General Description

Use this Memory Block per Common Signalling Channel to allow or deny sending the station name.

Applicable for IPK R2000 and above.

## Display

Data No.	C-Channel 1-4	Title	Setting Data
1 0	: C C H 1	N A M E	N O
T I M E D I S P L A Y			

System Mode

1

Submode

15

Data No.

10

PC Programming

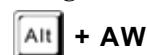

## Settings

LK1	LK2	LK3	LK4	LK5	LK6	LK7	LK8
NO	YS						

The shaded area indicates the default setting.

## Programming Procedures

1	Go off-line.
2	Press LK1 + LK15 +   to access the Memory Block.
3	Press the corresponding CO/PBX line key to change the option.
4	Press  to write the data.
5	Press  to go back on-line.

## Related Programming

M.B. Number	Memory Block Name
7-1	Card Interface Slot Assignment
7-3-01	MIF (LCR) Assignment
7-3-02	MIF (SMDR) Assignment
1-15-00	K-CCIS Main/Remote Office Selection
1-15-02	Common Signal Channel Assignment
1-15-03	Originating Point Code Assignment
1-15-04	Destination Point Code Assignment
1-15-05	Destination Point Code Transfer Assignment
1-15-06	Originating Office Code Number Assignment
1-15-07	K-CCIS Message Response Timeout Assignment
1-15-08	Link Reconnect Allow/Deny Selection
1-15-09	K-CCIS Maximum Call Forwarding Hop Assignment
1-15-11	Centralised Billing Allow/Deny Selection

**Related Programming (Continued)**

M.B. Number	Memory Block Name
1-15-12	Centralised Billing – Point Code of Center Office Assignment
1-15-13	Centralised Day/Night Switching for Remote Office Assignment
1-15-14	Centralised Day/Night Switching for Main Office Assignment
1-15-15	Centralised BLF Send Point Code Assignment
1-15-16	Centralised BLF Send Extension Number Assignment
1-15-17	Centralised BLF Send Time Assignment
1-15-18	Centralised BLF Display Extension Number Assignment
3-70	CIC Number Assignment
5-05	Common Signalling Channel Route Selection
1-1-05	Start Time Selection
1-5-02	SMDR Print Format
1-5-13	Printer Connected Selection
1-5-14	Printer Line Feed Control Selection
1-5-25	SMDR Valid Call Time Assignment
1-5-26	SMDR Incoming/Outgoing Print Selection
1-8-35	COM Port Baud Rate Setting Assignment
4-56	SMDR Telephone Print Selection

**N**

1. This Memory Block determines whether or not the station name is sent to the distant system.
2. This Memory Block is not used with and has no effect on the IP (K-CCIS) feature.

# Centralised Billing Allow/ Deny Selection

*System Mode*  
**1**

*Submode*  
**15**

*Data No.*  
**11**

*PC Programming*  
 + **AW**

## General Description

Use this Memory Block to assign the Electra Elite IPK to send billing to the Billing Center Office (NEAX2000/2400) across the K-CCIS network. Xen IPK does not support receiving and managing billing information.

Applicable for IPK R2000 and above.

## Display





	<small>Data No.</small>		<small>Title</small>		<small>Setting Data</small>				
	1 1	:	B I L L I N G		N O				
	T I M E D I S P L A Y								

## Settings

LK1	LK2	LK3	LK4	LK5	LK6	LK7	LK8
NO (Deny)	YS (Allow)						

The shaded area indicates the default setting.

## Programming Procedures

- 1 Go off-line.
- 2 Press LK1 + LK15 +   to access the Memory Block.
- 3 Press the corresponding CO/PBX line key to change the option.
- 4 Press  to write the data.
- 5 Press  to go back on-line.

## Related Programming

M.B. Number	Memory Block Name
7-1	Card Interface Slot Assignment
7-3-01	MIF (LCR) Assignment
7-3-02	MIF (SMDR) Assignment
1-15-00	K-CCIS Main/Remote Office Selection
1-15-02	Common Signal Channel Assignment
1-15-03	Originating Point Code Assignment
1-15-04	Destination Point Code Assignment
1-15-05	Destination Point Code Transfer Assignment
1-15-06	Originating Office Code Number Assignment
1-15-07	K-CCIS Message Response Timeout Assignment
1-15-08	Link Reconnect Allow/Deny Selection
1-15-09	K-CCIS Maximum Call Forwarding Hop Assignment

Doc. No.: 8194 - Release 2.0  
December 2004



**Related Programming (Continued)**

M.B. Number	Memory Block Name
1-15-10	Calling Name Display Allow/Deny Selection
1-15-12	Centralised Billing – Point Code of Center Office Assignment
1-15-13	Centralised Day/Night Switching for Remote Office Assignment
1-15-14	Centralised Day/Night Switching for Main Office Assignment
1-15-15	Centralised BLF Send Point Code Assignment
1-15-16	Centralised BLF Send Extension Number Assignment
1-15-17	Centralised BLF Send Time Assignment
1-15-18	Centralised BLF Display Extension Number Assignment
3-70	CIC Number Assignment
5-05	Common Signalling Channel Route Selection
1-1-05	Start Time Selection
1-5-02	SMDR Print Format
1-5-13	Printer Connected Selection
1-5-14	Printer Line Feed Control Selection
1-5-25	SMDR Valid Call Time Assignment
1-5-26	SMDR Incoming/Outgoing Print Selection
1-8-35	COM Port Baud Rate Setting Assignment
4-56	SMDR Telephone Print Selection

**N**

Memory Block 1-15-00 (K-CCIS Main/Remote Office Selection) does not apply for the Centralised Billing - K-CCIS feature.

# Centralised Billing – Point Code of Centre Office Assignment

System Mode  
**1**

Submode  
**15**

Data No.  
**12**

PC Programming  
 + **AW**

## General Description

Use this Memory Block to assign the Common Signalling Channel number and point code of the Billing Center Office (NEAX2000/2400).

Applicable for IPK R2000 and above.

## Display

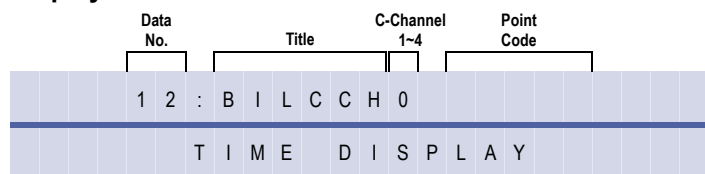









## Settings

LK1	LK2	LK3	LK4	LK5	LK6	LK7	LK8
NO (Deny)	YS (Allow)						

The shaded area indicates the default setting.

## Programming Procedures

1	Go off-line.	
2	Press LK1 + LK15 +   to access the Memory Block.	
3	Use dial pad keys to enter C-Channel and Point Code. <b>Note:</b> Use the following to enter data:  to move cursor left.  to move cursor right.  ~  to enter numeric data. Point Code range is 0001~16367.	<b>Default Values:</b> Blank
4	Press  to write the data.	
5	Press  to go back on-line.	

## Related Programming

M.B. Number	Memory Block Name
7-1	Card Interface Slot Assignment
7-3-01	MIF (LCR) Assignment
7-3-02	MIF (SMDR) Assignment
1-15-00	K-CCIS Main/Remote Office Selection
1-15-02	Common Signal Channel Assignment
1-15-03	Originating Point Code Assignment
1-15-04	Destination Point Code Assignment

**Related Programming (Continued)**

<b>M.B. Number</b>	<b>Memory Block Name</b>
<b>1-15-05</b>	Destination Point Code Transfer Assignment
<b>1-15-06</b>	Originating Office Code Number Assignment
<b>1-15-07</b>	K-CCIS Message Response Timeout Assignment
<b>1-15-08</b>	Link Reconnect Allow/Deny Selection
<b>1-15-09</b>	K-CCIS Maximum Call Forwarding Hop Assignment
<b>1-15-10</b>	Calling Name Display Allow/Deny Selection
<b>1-15-11</b>	Centralised Billing Allow/Deny Selection
<b>1-15-13</b>	Centralised Day/Night Switching for Remote Office Assignment
<b>1-15-14</b>	Centralised Day/Night Switching for Main Office Assignment
<b>1-15-15</b>	Centralised BLF Send Point Code Assignment
<b>1-15-16</b>	Centralised BLF Send Extension Number Assignment
<b>1-15-17</b>	Centralised BLF Send Time Assignment
<b>1-15-18</b>	Centralised BLF Display Extension Number Assignment
<b>3-70</b>	CIC Number Assignment
<b>5-05</b>	Common Signalling Channel Route Selection
<b>1-1-05</b>	Start Time Selection
<b>1-5-02</b>	SMDR Print Format
<b>1-5-13</b>	Printer Connected Selection
<b>1-5-14</b>	Printer Line Feed Control Selection
<b>1-5-25</b>	SMDR Valid Call Time Assignment
<b>1-5-26</b>	SMDR Incoming/Outgoing Print Selection
<b>1-8-35</b>	COM Port Baud Rate Setting Assignment
<b>4-56</b>	SMDR Telephone Print Selection

**N**

1. The Xen IPK can be only a Remote Office for a NEAX2000/2400 Billing Center Office.
2. When the Xen IPK is a tandem office and Billing Information is not required, this assignment is not necessary.

# Centralised Day/Night Switching for Remote Office Assignment

## General Description

Use this Memory Block to assign the Xen IPK to switch Day/Night mode when it receives the command from a main office.

Applicable for IPK R2000 and above.

## Display





Data No.	Title	Setting Data
13	CEN D / N	NO
T I M E D I S P L A Y		

## Settings

LK1	LK2	LK3	LK4	LK5	LK6	LK7	LK8
NO (Deny)	YS (Allow)						

The shaded area indicates the default setting.

## Programming Procedures

1	Go off-line.
2	Press LK1 + LK15 +   to access the Memory Block.
3	Press the corresponding CO/PBX line key to change the Setting Data option.
4	Press  to write the data, and display the next Memory Block.
5	Program the next Memory Block or press  to go back on-line.

## Related Programming

M.B. Number	Memory Block Name
7-1	Card Interface Slot Assignment
7-3-01	MIF (LCR) Assignment
7-3-02	MIF (SMDR) Assignment
1-15-00	K-CCIS Main/Remote Office Selection
1-15-02	Common Signal Channel Assignment
1-15-03	Originating Point Code Assignment
1-15-04	Destination Point Code Assignment
1-15-05	Destination Point Code Transfer Assignment
1-15-06	Originating Office Code Number Assignment
1-15-07	K-CCIS Message Response Timeout Assignment
1-15-08	Link Reconnect Allow/Deny Selection

System Mode

1

Submode

15

Data No.

13

PC Programming

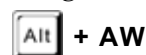

**Related Programming (Continued)**

M.B. Number	Memory Block Name
1-15-09	K-CCIS Maximum Call Forwarding Hop Assignment
1-15-10	Calling Name Display Allow/Deny Selection
1-15-11	Centralised Billing Allow/Deny Selection
1-15-12	Centralised Billing – Point Code of Center Office Assignment
1-15-14	Centralised Day/Night Switching for Main Office Assignment
1-15-15	Centralised BLF Send Point Code Assignment
1-15-16	Centralised BLF Send Extension Number Assignment
1-15-17	Centralised BLF Send Time Assignment
1-15-18	Centralised BLF Display Extension Number Assignment
3-70	CIC Number Assignment
5-05	Common Signalling Channel Route Selection
1-1-05	Start Time Selection
1-5-02	SMDR Print Format
1-5-13	Printer Connected Selection
1-5-14	Printer Line Feed Control Selection
1-5-25	SMDR Valid Call Time Assignment
1-5-26	SMDR Incoming/Outgoing Print Selection
1-8-35	COM Port Baud Rate Setting Assignment
4-56	SMDR Telephone Print Selection

**N**

1. Memory Block 1-15-00 (K-CCIS Main/Remote Office Selection) is used for the Centralised Day/Night Switching - K-CCIS feature when using traditional K-CCIS.
2. This Memory Block is used for the Remote Office only.

# Centralised Day/Night Switching for Main Office Assignment

System Mode  
**1**

Submode  
**15**

Data No.  
**14**

PC Programming  
 + AW

## General Description







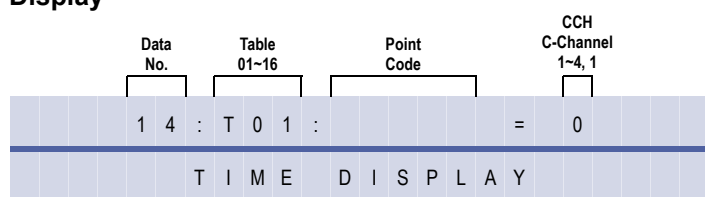

Use this Memory Block to assign the Point Codes and the CCH Channel to control remote systems for Centralised Day/Night Switching.

A CCH Channel of i can be assigned for K-CCIS over IP (**System Software R2000 or higher**).

## Display



## Programming Procedures

1	Go off-line.	
2	Press LK1 + LK15 +   to access the Memory Block.	
3	Use dial pad keys to enter Table number, CCH Channel, and Point Code. Press Redial + 1 to assign i for K-CCIS over IP ( <b>System Software R2000 or higher</b> ).	<b>Default Values:</b> All Tables Not Specified.
	<b>Note:</b> Use the following to enter data:  to move cursor left.  to move cursor right.  ~  to enter numeric data. Point Code range is 0001~16367. Tables 01~16 can be assigned.	
4	Press  to write the data, and display the next Memory Block.	
5	Repeat Steps 3 and 4 for each table. The next Memory Block is displayed.	
6	Program the next Memory Block or press  to go back on-line.	

## Related Programming

M.B. Number	Memory Block Name
7-1	Card Interface Slot Assignment
7-3-01	MIF (LCR) Assignment
7-3-02	MIF (SMDR) Assignment
1-15-00	K-CCIS Main/Remote Office Selection
1-15-02	Common Signal Channel Assignment
1-15-03	Originating Point Code Assignment

**Related Programming (Continued)**

<b>M.B. Number</b>	<b>Memory Block Name</b>
<b>1-15-04</b>	Destination Point Code Assignment
<b>1-15-05</b>	Destination Point Code Transfer Assignment
<b>1-15-06</b>	Originating Office Code Number Assignment
<b>1-15-07</b>	K-CCIS Message Response Timeout Assignment
<b>1-15-08</b>	Link Reconnect Allow/Deny Selection
<b>1-15-09</b>	K-CCIS Maximum Call Forwarding Hop Assignment
<b>1-15-10</b>	Calling Name Display Allow/Deny Selection
<b>1-15-11</b>	Centralised Billing Allow/Deny Selection
<b>1-15-12</b>	Centralised Billing – Point Code of Center Office Assignment
<b>1-15-13</b>	Centralised Day/Night Switching for Remote Office Assignment
<b>1-15-15</b>	Centralised BLF Send Point Code Assignment
<b>1-15-16</b>	Centralised BLF Send Extension Number Assignment
<b>1-15-17</b>	Centralised BLF Send Time Assignment
<b>1-15-18</b>	Centralised BLF Display Extension Number Assignment
<b>3-70</b>	CIC Number Assignment
<b>5-05</b>	Common Signalling Channel Route Selection
<b>1-1-05</b>	Start Time Selection
<b>1-5-02</b>	SMDR Print Format
<b>1-5-13</b>	Printer Connected Selection
<b>1-5-14</b>	Printer Line Feed Control Selection
<b>1-5-25</b>	SMDR Valid Call Time Assignment
<b>1-5-26</b>	SMDR Incoming/Outgoing Print Selection
<b>1-8-35</b>	COM Port Baud Rate Setting Assignment
<b>4-56</b>	SMDR Telephone Print Selection

**N**

1. Memory Block 1-15-00 (K-CCIS Main/Remote Office Selection) is used for the Centralised Day/Night Switching feature.
2. This Memory Block is used for the Main Office only.
3. Up to 16 Remote Offices can be controlled by a Main Office.
4. The Xen IPK cannot be a Main Office for a NEAX2000/2400 PBX.

# Centralised BLF Send Point Code Assignment

System Mode  
**1**

Submode  
**15**

Data No.  
**15**

PC Programming  
 + AW

## General Description







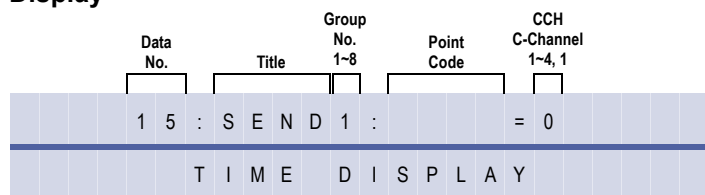

Use this Memory Block to assign the Point Codes and the CCH Channel to control remote systems for Centralised Day/Night Switching.

**System Software R2000 or higher is required.**

## Display



## Programming Procedures

<b>1</b>	Go off-line.	
<b>2</b>	Press LK1 + LK15 +   to access the Memory Block.	
<b>3</b>	Use dial pad keys to enter Group No., CCH Channel, and Point Code. Press Redial + 1 to assign i for K-CCIS over IP ( <b>System Software R2000 or higher</b> ).	<b>Default Values:</b> All Tables Not Specified.
	<b>Note:</b> Use the following to enter data:  to move cursor left.  to move cursor right.  ~  to enter numeric data. Point Code range is 0001~16367. Group No. 1~8 can be assigned.	
<b>4</b>	Press  to write the data, and display the next Memory Block.	
<b>5</b>	Repeat Steps 3 and 4 for each Group No.	
<b>6</b>	Program the next Memory Block or press  to go back on-line.	

## Related Programming

M.B. Number	Memory Block Name
<b>7-1</b>	Card Interface Slot Assignment
<b>1-8-08</b>	Class of Service (Station) Feature Selection 2 (Page 6, LK 2)
<b>1-15-00</b>	K-CCIS Main/Remote Office Selection
<b>1-15-02</b>	Common Signal Channel Assignment
<b>1-15-03</b>	Originating Point Code Assignment
<b>1-15-04</b>	Destination Point Code Assignment
<b>1-15-05</b>	Destination Point Code Transfer Assignment
<b>1-15-06</b>	Originating Office Code Number Assignment



**Related Programming (Continued)**

M.B. Number	Memory Block Name
1-15-07	K-CCIS Message Response Timeout Assignment
1-15-08	Link Reconnect Allow/Deny Selection
1-15-09	K-CCIS Maximum Call Forwarding Hop Assignment
1-15-10	Calling Name Display Allow/Deny Selection
1-15-11	Centralised Billing Allow/Deny Selection
1-15-12	Centralised Billing – Point Code of Center Office Assignment
1-15-13	Centralised Day/Night Switching for Remote Office Assignment
1-15-14	Centralised Day/Night Switching for Main Office Assignment
1-15-16	Centralised BLF Send Extension Number Assignment
1-15-17	Centralised BLF Send Time Assignment
1-15-18	Centralised BLF Display Extension Number Assignment
3-70	CIC Number Assignment
4-12	Line Key Selection for Telephone Mode
4-17	Station to Class of Service Feature Assignment
5-05	Common Signalling Channel Route Assignment

**N**

Up to eight Remote Offices can be sent Busy Lamp Field (BLF) status messages.

# Centralised BLF Send Extension Number Assignment

*System Mode*  
**1**  
*Submode*  
**15**  
*Data No.*  
**16**  
*PC Programming*  
 + **AW**

## General Description

Use this Memory Block to assign the Extension Numbers for sending Centralised BLF messages.

**System Software R2000 or higher is required.**

## Display

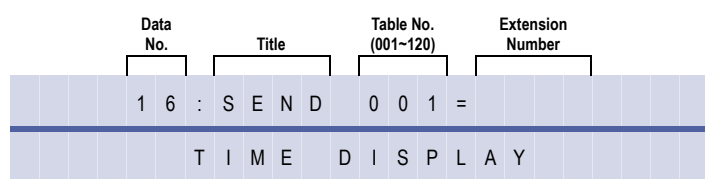









## Settings

LK1	LK2	LK3	LK4	LK5	LK6	LK7	LK8
Send Group 1	Send Group 2	Send Group 3	Send Group 4	Send Group 5	Send Group 6	Send Group 7	Send Group 8

The shaded area indicates the default setting.

## Programming Procedures

<b>1</b>	Go off-line.	
<b>2</b>	Press LK1 + LK15 +   to access the Memory Block.	
<b>3</b>	Use dial pad keys to enter Table number and Extension No. <b>Note:</b> Use the following to enter data:  to move cursor left.  to move cursor right.  ~  to enter numeric data. Three Digit Extension Number: 000~999 Four Digit Extension Number: 0000~9999 Tables 001~120 can be assigned.	<b>Default Values:</b> All Tables Not Specified
<b>4</b>	Press corresponding CO/PBX line key to select the Send Group No.	
<b>5</b>	Press  to write the data, and display the next Memory Block.	
<b>6</b>	Repeat Steps 3 and 4 for each Send Group No.	
<b>7</b>	Program the next Memory Block or press  to go back on-line.	

## Related Programming

M.B. Number	Memory Block Name
7-1	Card Interface Slot Assignment
1-8-08	Class of Service (Station) Feature Selection 2 (Page 6, LK 2)
1-15-00	K-CCIS Main/Remote Office Selection
1-15-02	Common Signal Channel Assignment
1-15-03	Originating Point Code Assignment
1-15-04	Destination Point Code Assignment
1-15-05	Destination Point Code Transfer Assignment
1-15-06	Originating Office Code Number Assignment
1-15-07	K-CCIS Message Response Timeout Assignment
1-15-08	Link Reconnect Allow/Deny Selection
1-15-09	K-CCIS Maximum Call Forwarding Hop Assignment
1-15-10	Calling Name Display Allow/Deny Selection
1-15-11	Centralised Billing Allow/Deny Selection
1-15-12	Centralised Billing – Point Code of Center Office Assignment
1-15-13	Centralised Day/Night Switching for Remote Office Assignment
1-15-14	Centralised Day/Night Switching for Main Office Assignment
1-15-15	Centralised BLF Send Extension Number Assignment
1-15-17	Centralised BLF Send Time Assignment
1-15-18	Centralised BLF Display Extension Number Assignment
3-70	CIC Number Assignment
4-12	Line Key Selection for Telephone Mode
4-17	Station to Class of Service Feature Assignment
5-05	Common Signalling Channel Route Assignment

## N

1. The Send Group Number selected by the Line Key is the Group number assigned in Memory Block 1-15-15 (Centralised BLF Send Point Code Assignment).
2. Up to 120 Extension Numbers (entries in the table) can be assigned to send BLF messages. With each assigned extension number, up to eight destination offices can be selected until 240 extension numbers are assigned.
3. A maximum of 240 total sending Extension Numbers (BLF messages) can be assigned. If 30 Extension Numbers (entries in the table) are assigned with each set for all eight groups (systems), the 240 limit is reached and no more Extension Numbers can be entered.
4. When a Send Group (Point Code) is cleared in Memory Block 1-15-15, it is also cleared in this Memory Block.

# Centralised BLF Send Time Assignment

## General Description

Use this Memory Block to assign the time interval for sending BLF information across the K-CCIS Network.

**System Software R2000 or higher is required.**

## Display

Data No.	Title	Setting Data
17	SEND TIME	04s
TIME DISPLAY		

System Mode  
**1**

Submode  
**15**

Data No.  
**17**





PC Programming  
 + **AW**

## Settings

LK1	LK2	LK3	LK4	LK5	LK6	LK7	LK8
4 Seconds (04s)	4 Seconds (08s)	4 Seconds (12s)	4 Seconds (16s)				

The shaded area indicates the default setting.

## Programming Procedures

1	Go off-line.
2	Press LK1 + LK15 +   to access the Memory Block.
3	Press corresponding CO/PBX line key to change the Setting Data option.
4	Press  to write the data, and display the next Memory Block.
5	Program the next Memory Block or press  to go back on-line.

## Related Programming

M.B. Number	Memory Block Name
7-1	Card Interface Slot Assignment
7-3-01	MIF (LCR) Assignment
7-3-02	MIF (SMDR) Assignment
1-15-00	K-CCIS Main/Remote Office Selection
1-15-02	Common Signal Channel Assignment
1-15-03	Originating Point Code Assignment
1-15-04	Destination Point Code Assignment
1-15-05	Destination Point Code Transfer Assignment
1-15-06	Originating Office Code Number Assignment
1-15-07	K-CCIS Message Response Timeout Assignment
1-15-08	Link Reconnect Allow/Deny Selection
1-15-09	K-CCIS Maximum Call Forwarding Hop Assignment

**Related Programming (Continued)**

M.B. Number	Memory Block Name
1-15-10	Calling Name Display Allow/Deny Selection
1-15-11	Centralised Billing Allow/Deny Selection
1-15-12	Centralised Billing – Point Code of Center Office Assignment
1-15-13	Centralised Day/Night Switching for Remote Office Assignment
1-15-14	Centralised Day/Night Switching for Main Office Assignment
1-15-15	Centralised BLF Send Point Code Assignment
1-15-16	Centralised BLF Send Extension Number Assignment
1-15-18	Centralised BLF Display Extension Number Assignment
3-70	CIC Number Assignment
4-12	Line Key Selection for Telephone Mode
4-17	Station to Class of Service Feature Selection
5-05	Common Signalling Channel Route Selection

**N**

The BLF messages are sent in a four-second cycle (at default), so some delay occurs to change the indication in the destination office. In the network configured with two systems, it can take four to five seconds (at default) to change the BLF indication in the destination office.

# Centralised BLF Receive Extension Number Assignment

System Mode  
**1**

Submode  
**15**

Data No.  
**18**

PC Programming  
 + AW

## General Description









Use this Memory Block to assign the Extension Numbers of remote systems to receive Centralised BLF messages.

**System Software R2000 or higher is required.**

## Display

Data No.	Title	Table Number 001~120	Extension Number
18	BLF	001	= _
T I M E D I S P L A Y			

## Programming Procedures

1	Go off-line.	
2	Press LK1 + LK15 +   to access the Memory Block.	
3	Use dial pad keys to enter Table number and Extension No. <b>Note:</b> Use the following to enter data:  to move cursor left.  to move cursor right.  ~  to enter numeric data. Three Digit Extension Number: 000~999 Four Digit Extension Number: 0000~9999 Tables 001~120 can be assigned.	<b>Default Values:</b> All Tables Not Specified
4	Press  to write the data, and display the next Memory Block.	
5	Repeat Steps 3 and 4 for each Table No.	
6	Program the next Memory Block or press  to go back on-line.	

## Related Programming

M.B. Number	Memory Block Name
7-1	Card Interface Slot Assignment
1-8-08	Class of Service (Station) Feature Selection 2 (Page 6, LK 2)
1-15-00	K-CCIS Main/Remote Office Selection
1-15-02	Common Signal Channel Assignment
1-15-03	Originating Point Code Assignment
1-15-04	Destination Point Code Assignment
1-15-05	Destination Point Code Transfer Assignment

**Related Programming (Continued)**

M.B. Number	Memory Block Name
1-15-06	Originating Office Code Number Assignment
1-15-07	K-CCIS Message Response Timeout Assignment
1-15-08	Link Reconnect Allow/Deny Selection
1-15-09	K-CCIS Maximum Call Forwarding Hop Assignment
1-15-10	Calling Name Display Allow/Deny Selection
1-15-11	Centralised Billing Allow/Deny Selection
1-15-12	Centralised Billing – Point Code of Center Office Assignment
1-15-13	Centralised Day/Night Switching for Remote Office Assignment
1-15-14	Centralised Day/Night Switching for Main Office Assignment
1-15-15	Centralised BLF Send Point Code Assignment
1-15-16	Centralised BLF Send Extension Number Assignment
1-15-17	Centralised BLF Send Time Assignment
3-70	CIC Number Assignment
4-12	Line Key Selection for Telephone Mode
4-17	Station to Class of Service Feature Assignment
5-05	Common Signalling Channel Route Assignment

**N**

1. Up to 120 remote Telephone's BLF can be received per system.
2. All Multiline Terminals in the system can assign DSS/BLF keys for the supported remote telephone's BLF.

THIS PAGE INTENTIONALLY LEFT BLANK





# Trunk to Tenant Assignment

## General Description

Use this Memory Block to assign CO/PBX lines to a tenant.

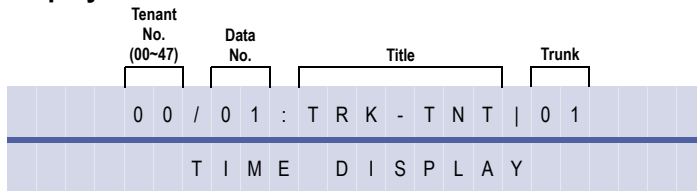
## Display



*System Mode*  
**2**  
*Submode*  
**—**  
*Data No.*  
**01**  
*PC Programming*  
 + BN

## Settings

### (Page 1)

LK 1	LK 2	LK 3	LK 4
01	02	03	04
LK 5	LK 6	LK 7	LK 8
05	06	07	08

### (Page 2)

LK 1	LK 2	LK 3	LK 4
09	10	11	12
LK 5	LK 6	LK 7	LK 8
13	14	15	16

### (Page 3)

LK 1	LK 2	LK 3	LK 4
17	18	19	20
LK 5	LK 6	LK 7	LK 8
21	22	23	24

### (Page 4)

LK 1	LK 2	LK 3	LK 4
25	26	27	28
LK 5	LK 6	LK 7	LK 8
29	30	31	32

### (Page 5)

LK 1	LK 2	LK 3	LK 4
33	34	35	36
LK 5	LK 6	LK 7	LK 8
37	38	39	40

### (Page 6)

LK 1	LK 2	LK 3	LK 4
41	42	43	44
LK 5	LK 6	LK 7	LK 8
45	46	47	48

### (Page 7)











LK 1	LK 2	LK 3	LK 4
49	50	51	52
LK 5	LK 6	LK 7	LK 8
53	54	55	56

### (Page 8)

LK 1	LK 2	LK 3	LK 4
57	58	59	60
LK 5	LK 6	LK 7	LK 8
61	62	63	64

**Note:** All line keys are a default setting.

**Programming Procedures**

<b>1</b>	Go off-line.						
<b>2</b>	Press LK2 +   to access the Memory Block.						
<b>3</b>	<p>Press the corresponding CO/PBX line key to change the data option.</p> <p><b>Note:</b> Use the following to enter data:</p> <ul style="list-style-type: none"> <li> to move the cursor left</li> <li> to move the cursor right</li> <li> ~  to enter numeric data</li> <li> to go to the next Tenant No.</li> <li> to go to the next page</li> <li> to go to the previous page</li> </ul> <table border="1" style="margin-left: 20px;"> <thead> <tr> <th style="text-align: center;">CO/PBX Line LED</th> <th style="text-align: center;">Off</th> <th style="text-align: center;">Off</th> </tr> </thead> <tbody> <tr> <td style="text-align: center;">Data</td> <td style="text-align: center;">No (Not Assigned)</td> <td style="text-align: center;">Yes (Assigned)</td> </tr> </tbody> </table> <p style="margin-left: 20px;">There is no default setting.</p>	CO/PBX Line LED	Off	Off	Data	No (Not Assigned)	Yes (Assigned)
CO/PBX Line LED	Off	Off					
Data	No (Not Assigned)	Yes (Assigned)					
<b>4</b>	Press  to write the data.						
<b>5</b>	Press  to go back on-line.						

**Default Values**

Tenant 00	Tenant 01~47
CO/PBX lines 01~64 assigned (YES)	Not assigned

**Related Programming**

M.B. Number	Memory Block Name
<b>2-05</b>	Line Key Selection
<b>4-09</b>	Telephone to Tenant Assignment

**N**

If data is changed while the system is busy, DATA ENTRY is displayed at the programming station until the system becomes idle.

# Line Key Selection

## General Description

Use this Memory Block to allow the technician to specify either of two line key assignment modes for each tenant. The choices are Tenant-Wide Mode or Telephone Mode.

## Display

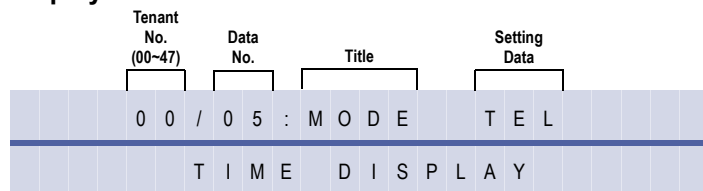





System Mode  
**2**  
Submode  
—  
Data No.  
**05**  
PC Programming  
 + BN

## Settings

LK 1	LK 2	LK 3	LK 4
Tenant-Wide Mode	Telephone Mode		
LK 5	LK 6	LK 7	LK 8

The shaded area indicates the default setting.

## Programming Procedures

- 1 Go off-line.
- 2 Press LK2 +   to access the Memory Block.
- 3 Press the corresponding CO/PBX line key to change the data option.
- 4 Press  to write the data.
- 5 Press  to go back on-line.

## Related Programming

M.B. Number	Memory Block Name
<b>2-06</b>	Line Key Selection for Tenant Mode
<b>4-12</b>	Line Key Selection for Telephone Mode

# N

1. Mixed use of Tenant-Wide Mode and Telephone Mode in the system is permitted.
2. Tenant-Wide Mode:  
Memory Block 2-06 Line Key Selection for Tenant Mode permits assignment of any desired feature to each of the CO/PBX line keys. All the telephones in a tenant are assigned the same features.
3. Telephone Mode:  
Memory Block 4-12 Line Key Selection for Telephone Mode permits assignment of any feature to each of the CO/PBX line keys. Each telephone can be assigned different features.

# Line Key Selection for Tenant Mode

## General Description

This Memory Block allows the assignment of functions to each of the CO/PBX line keys on each telephone in a tenant specified as Tenant Mode in Memory Block 2-05 Line Key Selection.

## Display

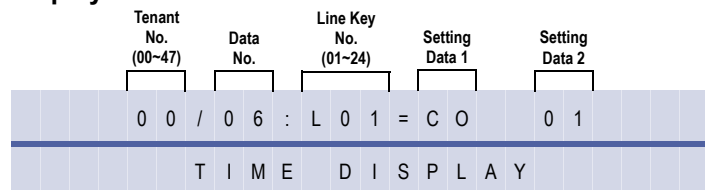

System Mode  
**2**

Submode  
—

Data No.  
**06**

PC Programming  
 + BN

## Settings

### (Page 1)

LK 1	LK 2	LK 3	LK 4
Not Specified	CO/PBX Line	CFW - BNA	CFW - ALL
LK 5	LK 6	LK 7	LK 8
Call Appearance	Feature Access	Trunk Group	Route Advance

### (Page 2)

LK 9	LK102	LK 11	LK 12
SIE/CAR Key	Microphone Key	Headset	Scroll Key (Used with Caller ID)
LK 13	LK 14	LK 15	LK 16
DND On/Off	Log On/Off	BGM On/Off	ICM Key

The shaded area indicates the default setting.

## Programming Procedures

1	Go off-line.
2	Press LK2 +   to access the Memory Block.

**Programming Procedures**

<p><b>3</b> Press the corresponding CO/PBX line key to change the data option. The operation data includes: <b>Setting Data</b></p> <table border="1" style="width: 100%; border-collapse: collapse;"> <thead> <tr> <th style="width: 10%;">Line Key</th> <th style="width: 30%;">Setting Data (1)</th> <th style="width: 20%;">LCD Indication</th> <th style="width: 40%;">Setting Data (2)</th> </tr> </thead> <tbody> <tr><td>1</td><td>Not Specified</td><td>NON</td><td>N/A</td></tr> <tr><td>2</td><td>CO</td><td>CO</td><td>01~64</td></tr> <tr><td>3</td><td>CFW - BNA</td><td>FW BNA</td><td>N/A</td></tr> <tr><td>4</td><td>CFW - ALL</td><td>FW ALL</td><td>N/A</td></tr> <tr><td>5</td><td>Call Appearance Block (00~47)</td><td>C</td><td>Call Appearance Key 01~24</td></tr> <tr><td>6</td><td>Feature Access</td><td>FA</td><td>01~16</td></tr> <tr><td>7</td><td>Trunk Group</td><td>TKGP</td><td>01~32</td></tr> <tr><td>8</td><td>Route Advance</td><td>ADV</td><td>01~32</td></tr> <tr><td>9</td><td>SIE/CAR Key</td><td>SIE</td><td>Telephone Port No. 01~C0</td></tr> <tr><td>10</td><td>Microphone</td><td>MIC</td><td>N/A</td></tr> <tr><td>11</td><td>Headset</td><td>H SET</td><td>N/A</td></tr> <tr><td>12</td><td>Scroll Key</td><td>SCROLL</td><td>N/A</td></tr> <tr><td>13</td><td>DND On/Off</td><td>DND</td><td>N/A</td></tr> <tr><td>14</td><td>Log On/Off</td><td>LOG</td><td>N/A</td></tr> <tr><td>15</td><td>BGM On/Off</td><td>BGM</td><td>N/A</td></tr> <tr><td>16</td><td>Intercom Key</td><td>ICM</td><td>N/A</td></tr> </tbody> </table> <p><b>Note:</b> The following are used when entering data:                      * to moves the cursor left                      # to moves the cursor right                      0-9 to enter the numeric data                      Conf to go to the next Tenant No.</p>	Line Key	Setting Data (1)	LCD Indication	Setting Data (2)	1	Not Specified	NON	N/A	2	CO	CO	01~64	3	CFW - BNA	FW BNA	N/A	4	CFW - ALL	FW ALL	N/A	5	Call Appearance Block (00~47)	C	Call Appearance Key 01~24	6	Feature Access	FA	01~16	7	Trunk Group	TKGP	01~32	8	Route Advance	ADV	01~32	9	SIE/CAR Key	SIE	Telephone Port No. 01~C0	10	Microphone	MIC	N/A	11	Headset	H SET	N/A	12	Scroll Key	SCROLL	N/A	13	DND On/Off	DND	N/A	14	Log On/Off	LOG	N/A	15	BGM On/Off	BGM	N/A	16	Intercom Key	ICM	N/A	<p><b>Default Values</b></p> <table border="1" style="width: 100%; border-collapse: collapse;"> <thead> <tr> <th style="width: 15%;">Line Keys</th> <th style="width: 40%;">Tenant 00</th> <th style="width: 45%;">Tenant 01~47</th> </tr> </thead> <tbody> <tr> <td>01~08</td> <td>CO/PBX lines 01~08</td> <td>Not assigned</td> </tr> <tr> <td>09~24</td> <td>Not assigned</td> <td>Not assigned</td> </tr> </tbody> </table>	Line Keys	Tenant 00	Tenant 01~47	01~08	CO/PBX lines 01~08	Not assigned	09~24	Not assigned	Not assigned
	Line Key	Setting Data (1)	LCD Indication	Setting Data (2)																																																																										
	1	Not Specified	NON	N/A																																																																										
	2	CO	CO	01~64																																																																										
	3	CFW - BNA	FW BNA	N/A																																																																										
	4	CFW - ALL	FW ALL	N/A																																																																										
	5	Call Appearance Block (00~47)	C	Call Appearance Key 01~24																																																																										
	6	Feature Access	FA	01~16																																																																										
	7	Trunk Group	TKGP	01~32																																																																										
	8	Route Advance	ADV	01~32																																																																										
	9	SIE/CAR Key	SIE	Telephone Port No. 01~C0																																																																										
	10	Microphone	MIC	N/A																																																																										
	11	Headset	H SET	N/A																																																																										
	12	Scroll Key	SCROLL	N/A																																																																										
	13	DND On/Off	DND	N/A																																																																										
	14	Log On/Off	LOG	N/A																																																																										
	15	BGM On/Off	BGM	N/A																																																																										
16	Intercom Key	ICM	N/A																																																																											
Line Keys	Tenant 00	Tenant 01~47																																																																												
01~08	CO/PBX lines 01~08	Not assigned																																																																												
09~24	Not assigned	Not assigned																																																																												
<b>4</b> Press CO/PBX LK7; TKGP is displayed.																																																																														
<b>5</b> Enter 05 (for RT 05) using the dial pad.																																																																														
<b>6</b> Press Transfer ; data of CO/PBX LK 01~24 is displayed successively.																																																																														
<b>7</b> After entering data for CO/PBX LK24, press Transfer to write the data.																																																																														
<b>8</b> Press Speaker to go back on-line.																																																																														

**Related Programming**

M.B. Number	Memory Block Name
<b>2-05</b>	Line Key Selection

# N

1. Specify Call Appearance as the call appearance number of Call Appearance Block numbers from Memory Block 4-44 Station to Call Appearance Block Assignment.
2. Use this Memory Block to assign the following functions to each of the CO/PBX line keys on each telephone in a tenant specified as Tenant Mode in Memory Block 2-05 Line Key Selection:
  - Ⓒ Not specified (NON)
  - Ⓒ CO/PBX Line (CO) 01~64
  - Ⓒ CFW - BNA
  - Ⓒ CFW - ALL
  - Ⓒ Call Appearance (C) 00~47, 01~24 (Each Call Appearance Block may have a maximum of 24 Call Appearance keys).
  - Ⓒ Feature Access (FA) 01~10
  - Ⓒ Trunk Group (TKGP) 01~32
  - Ⓒ Route Advance Block (ADV) 01~32
  - Ⓒ Secondary Incoming Extension (SIE) / Call Arrival Keys (CAR) 0~112
  - Ⓒ Microphone (MIC)
  - Ⓒ Headset (H SET)
  - Ⓒ Scroll Key
  - Ⓒ DND/Break Mode
  - Ⓒ Log On/Off
  - Ⓒ BGM On/Off
  - Ⓒ Intercom Key
3. Use this Memory Block only if Memory Block 2-05 is set to "Tenant Mode".

# System Speed Dial Display Assignment

## General Description

Use this Memory Block to specify whether or not confirmation of the Speed Dial numbers and messages stored in the system Speed Dial memory is allowed.

## Display

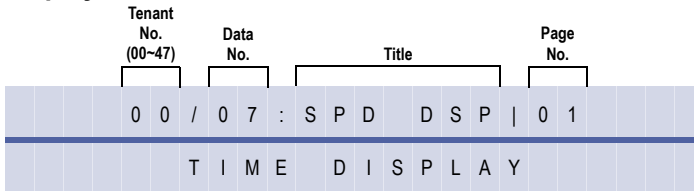

System Mode  
2  
Submode  
—  
Data No.  
07  
PC Programming  
 + BN

## Settings

### (Page 1)

When system Speed Dial is 90 buffers:

LK 1	LK 2	LK 3	LK 4
00~09	10~19	20~29	30~39
LK 5	LK 6	LK 7	LK 8
40~49	50~59	60~69	70~79

### (Page 2)

LK 1	LK 2	LK 3	LK 4
80~89			
LK 5	LK 6	LK 7	LK 8

### (Page 1)

When system Speed Dial is 1000 buffers:











LK 1	LK 2	LK 3	LK 4
000~099	100~199	200~299	300~399
LK 5	LK 6	LK 7	499
400~499	500~599	600~699	700~799

### (Page 2)

LK 1	LK 2	LK 3	LK 4
800~899	900~999		
LK 5	LK 6	LK 7	LK 8

**Note:** All line keys are a default setting.

**Programming Procedures**

<b>1</b>	Go off-line.						
<b>2</b>	Press LK2 +   to access the Memory Block.						
<b>3</b>	<p>Press the CO/PBX Line key. The LED indication changes to indicate the data each time the CO/PBX line key is pressed.</p> <p><b>Default Values</b> All Speed Dial confirmation allowed.</p> <p><b>Note:</b> Use the following to enter data:</p> <ul style="list-style-type: none"> <li> to move the cursor left</li> <li> to move the cursor right</li> <li> ~  to enter number data</li> <li> to go to next page</li> <li> to go to previous page</li> </ul> <table border="1" style="margin-left: 20px;"> <tr> <td style="text-align: center;"><b>CO/PBX Line LED</b></td> <td style="text-align: center;"><b>Off</b></td> <td style="text-align: center;"><b>On</b></td> </tr> <tr> <td style="text-align: center;"><b>Data</b></td> <td style="text-align: center;"><b>No (Not Assigned)</b></td> <td style="text-align: center;"><b>Yes (Assigned)</b></td> </tr> </table> <p style="margin-left: 20px;">There is no default setting.</p>	<b>CO/PBX Line LED</b>	<b>Off</b>	<b>On</b>	<b>Data</b>	<b>No (Not Assigned)</b>	<b>Yes (Assigned)</b>
<b>CO/PBX Line LED</b>	<b>Off</b>	<b>On</b>					
<b>Data</b>	<b>No (Not Assigned)</b>	<b>Yes (Assigned)</b>					
<b>4</b>	After entering data for all pages, press  to write the data.						
<b>5</b>	Press  to go back on-line.						

**Related Programming**

M.B. Number	Memory Block Name
<b>1-1-35</b>	Speed Dial Buffer Allocation
<b>1-8-07</b>	Class of Service (Attendant) Feature Selection 1

**N**

1. If Deny is specified, no display is presented even when a System Speed Dial call is originated.
2. Divide the Speed Dial numbers into groups and specify, per tenant, whether confirmation is allowed or denied.
3. Station Message Detail Recording (SMDR) prints telephone numbers.



# ECR Relay to Tenant Assignment

System Mode  
**2**

Submode  
**—**

Data No.  
**08**

PC Programming  
 + BN

## General Description

Use this Memory Block to specify Tenant Assignment for External Tone Ring/Night Chime function.

## Display

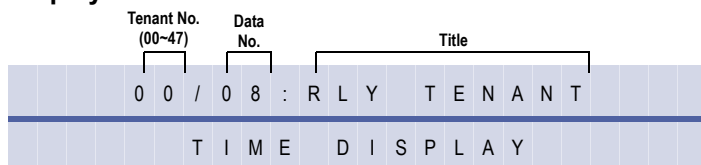







## Settings

LK 1	LK 2	LK 3	LK 4
External Tone Relay 1	External Tone Relay 2	External Tone Relay 3	External Tone Relay 4
LK 5	LK 6	LK 7	LK 8
Night Chime			

There is no default value.

## Programming Procedures

<b>1</b>	Go off-line.	
<b>2</b>	Press LK2 +   to access the Memory Block.	
<b>3</b>	Press the corresponding CO/PBX line key to change the data option. <b>Note:</b> Use the following to enter data:  to moves the cursor left  to moves the cursor right  to go to the next Tenant No.	<b>Default Values</b> All Tenants No Assignment
<b>4</b>	Press the  to write the data.	
<b>5</b>	Press  to go back on-line.	

## Related Programming

M.B. Number	Memory Block Name
<b>1-7-07</b>	External Ring Relay Cycle Selection

# N

1. By assigning Night Chime to a Tenant, incoming calls to the Tenant Group in Night Mode can be answered using the Night Call Pickup Access Code.
2. The relays are fixed (non programmable).
3. Night Chime must be assigned for Night Call Pickup to work. A relay may be assigned even if no ECR-U( ) ETU is installed in the system.

# Dial-In Tenant Incoming Limit Assignment

System Mode  
**2**

Submode  
**—**

Data No.  
**09**

PC Programming  
 + **BN**







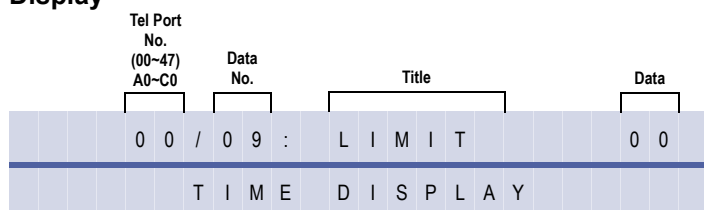



## General Description

Use this Memory Block to assign names for telephone stations.

## Display



## Programming Procedures

1	Go off-line.	
2	Press LK2 +   to access the Memory Block.	
3	Use the dial pad to enter data. <b>Note:</b> Use the following to enter data: <ul style="list-style-type: none"> <li> to move the cursor left</li> <li> to move the cursor right</li> <li> ~  to enter numeric data</li> <li> to go to next Tenant.</li> </ul> <b>Setting Data:</b> 0 = No Limit 1~64 = Number of effective incoming	<b>Default Values</b> No Limit = 0
4	Press  to write the data.	
5	After entering all data, press 	
6	Press  to go back on-line.	

## Related Programming

M.B. Number	Memory Block Name
2-01	Trunk to Tenant Assignment



Only DID incoming calls are limited. Outgoing calls, Internal (ICM) calls, and normal incoming calls are not limited.

# Trunk Name/Number Assignment

## General Description

Use this Memory Block to specify telephone name/number for the CO/PBX lines accommodated so that the information is displayed when the CO/PBX Line is seized, or during an incoming call.

With IPK R2000 and above this memory block is not applicable.

## Display

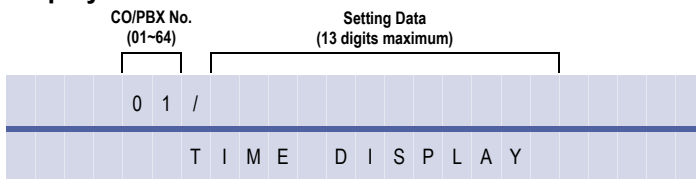

System Mode  
**3**

Submode  
—

Data No.  
**00**











PC Programming  
 + BCT

## Settings

LK 1	LK 2	LK 3	LK 4
Number	Name		
LK 5	LK 6	LK 7	LK 8

The shaded area indicates the default setting.

## Programming Procedures

<b>1</b>	Go off-line.	
<b>2</b>	Press LK3 +   to access the Memory Block.	
<b>3</b>	Use the dial pad to enter data. <b>Note:</b> Use the following enter data: <ul style="list-style-type: none"> <li> to moves the cursor left</li> <li> to moves the cursor right</li> <li> ~  to numeric keys for entering data</li> <li> to generate a - (hyphen)</li> <li> to generate a space (clear after hold)</li> <li> to go to the next CO/PBX Line No.</li> </ul>	<b>Default Values</b> Not Specified
<b>4</b>	Press  to write the data.	
<b>5</b>	Press  to go back on-line.	

## Related Programming

No related programming is necessary for this Memory Block.

# N

When a name is selected, refer to *Section 7, Character Code Tables, 7.1 Dial Pad Character Assignment on page 1-541* to get the character codes.

# Trunk Status Selection

## General Description





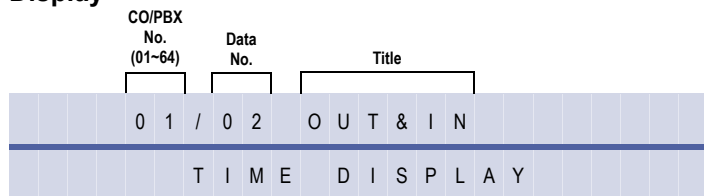

Use this Memory Block to specify whether a CO/PBX line is used for call origination and termination or termination only.

## Display



*System Mode*  
**3**  
*Submode*  
**—**  
*Data No.*  
**02**  
*PC Programming*  
 + BCT

## Programming Procedures

- 1 Go off-line.
- 2 Press LK3 +  +   to access the Memory Block.
- 3 Press the corresponding CO/PBX line key to change the data option.  
**Note:** Use the following to enter data:  
 to go to the next CO/PBX Line No.
- 4 Press  to write the data.
- 5 Press  to go back on-line.

## Related Programming

No related programming is necessary for this Memory Block.

# Trunk-to-Trunk Group Assignment

## General Description

Use this Memory Block to assign a Trunk Group Number (01~32) to each CO/PBX line.

## Display

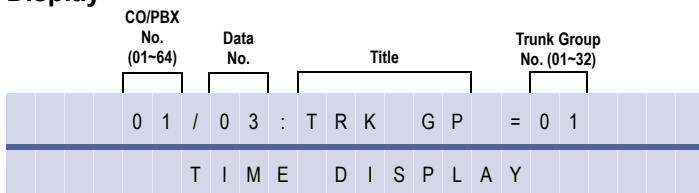

System Mode  
**3**  
 Submode  
 —  
 Data No.  
**03**  
 PC Programming  
 + BCT

## Programming Procedures

<b>1</b>	Go off-line.	
<b>2</b>	Press LK3 +  +   to access the Memory Block.	
<b>3</b>	Enter data using the dial pad. <b>Note:</b> Use the following enter data: to moves the cursor left to moves the cursor right ~  to enter numeric data to go to the next CO/PBX Line No. <b>Setting Data</b> 00 : Not set 01~32 : Trunk Group 01~32	<b>Default Values</b> CO/PBX lines (01~08) in Trunk Group 01 CO/PBX lines (09~64) in Trunk Group 00 All Tie lines in Trunk Group 02 All DID lines in Trunk Group 00 All ISDN lines in Trunk Group 00
<b>4</b>	Press  to write the data.	
<b>5</b>	Press  to go back on-line.	

## Related Programming

No related programming is necessary for this Memory Block.

# N

- When an Access Code corresponding to a Trunk Group is dialled, an idle CO line is selected automatically and seized from the same Trunk Group dialled (the CO line of either same tenant or another tenant can be seized).
- By specifying the priority order, up to four routes (Trunk Groups) can be selected in Memory Block 1-1-30 Route Advance Block Assignment. Idle CO lines are selected and seized in this sequence.
- If LCR is installed, Local Trunks should be assigned to Trunk Group 1. When a number is dialled that bypasses LCR, the system accesses Trunk Group 1 and dials the number.

# Trunk-to-Trunk Transfer Yes/ No Selection

## General Description

This Memory Block specifies whether or not to allow Trunk-to-Trunk Transfer.

## Display

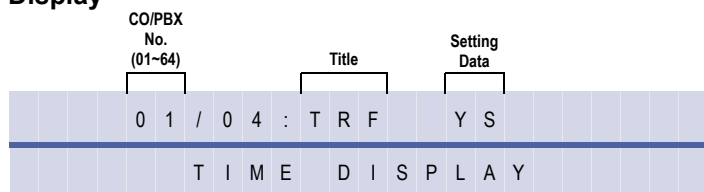

*System Mode*  
**3**

*Submode*  
—

*Data No.*  
**04**

*PC Programming*  
 + BCT

## Settings

LK 1	LK 2	LK 3	LK 4
No	Yes		
LK 5	LK 6	LK 7	LK 8

The shaded area indicates the default setting.

## Programming Procedures

- 1 Go off-line.
- 2 Press LK3 + + to access the Memory Block.
- 3 Press the corresponding CO/PBX line key to change the data option.  
**Note:** Use the following to enter data:
  - to move the cursor left
  - to move the cursor right
  - ~ to enter numeric data
  - to go to the next CO/PBX Line No.
- 4 Press to write the data.
- 5 Press to go back on-line.

## Related Programming

M.B. Number	Memory Block Name
<b>1-8-07</b>	Class of Service (Attendant) Feature Selection 1
<b>1-8-08</b>	Class of Service (Station) Feature Selection 2
<b>3-05</b>	Trunk Incoming Answer Mode Selection
<b>3-06</b>	Automatic Tandem Trunk Assignment
<b>5-01</b>	Tie Line Networking Tandem Connection Assignment



Assign Yes to connect both trunks via Trunk-to-Trunk Transfer or Automatic Trunk-to-Trunk Transfer feature.

# Trunk Incoming Answer Mode Selection

## General Description

This Memory Block specifies, per outside line, the incoming answer mode (Automatic Trunk-to-Trunk Transfer, Automated Attendant, or DISA).

## Display

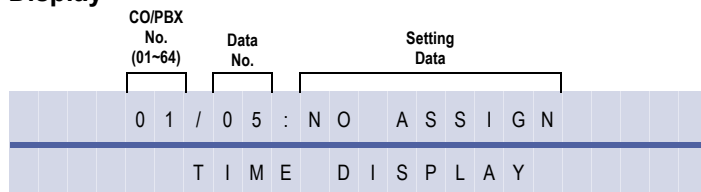

System Mode  
**3**

Submode  
—

Data No.  
**05**



PC Programming  
 + BCT

## Settings



LK 1	LK 2	LK 3	LK 4
Normal	Automatic Trunk-to-Trunk Transfer	Automated Attendant/DISA	
LK 5	LK 6	LK 7	LK 8

The shaded area indicates the default setting.

## Programming Procedures

- Go off-line.
- Press LK3 +  +   to access the Memory Block.
- Press the corresponding CO/PBX line key to change the data option.
 

Line Key	LCD Indication when Selected	Definition
LK 1	NO ASSIGN	Normal
LK 2	TANDEM TRF	Automatic Trunk-to-Trunk Transfer
LK 3	AA	Automated Attendant/DISA

**Note:** Use the following to enter data:  
 to go to the next CO/PBX Port No.
- Press  to write the data.
- Press  to go back on-line.

## Related Programming

M.B. Number	Memory Block Name
	Refer to <i>Chapter 2, Guide to Feature Programming</i> .

---

# N

1. Only trunks assigned to TANDM TRF in this Memory Block are set or cancelled for Automatic Trunk-to-Trunk Transfer Mode when an attendant position enters 00 during the set or cancel operation.  
For example:  
To set Automatic Trunk-to-Trunk Transfer Mode from an attendant position:  
Press A + FA + KK + A .  
To cancel Automatic Trunk-to-Trunk Transfer Mode from an attendant position:  
Press A + FB + KK + A .
2. Only trunks assigned to AA in this Memory Block are set or cancelled for Automated Attendant/DISA Mode when an attendant position enters 00 during the set or cancel operation.  
For example:  
To set Automated Attendant/DISA Mode from an attendant position:  
Press A + HA + KK + A .  
To cancel Automated Attendant/DISA Mode from an attendant position:  
Press A + HB + KK + A .



# Automatic Tandem Trunk Assignment

## General Description

Use this Memory Block to specify the incoming trunk and outgoing trunk for Automatic Trunk-to-Trunk Transfer.

## Display

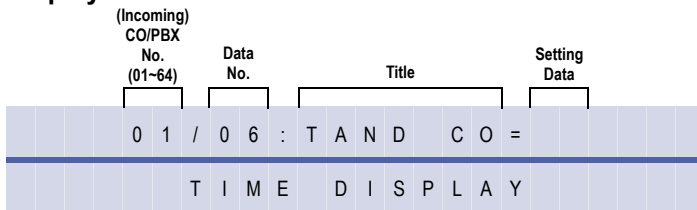

System Mode  
**3**

Submode  
—

Data No.  
**06**

PC Programming  
 + AT

## Programming Procedures

1	Go off-line.	
2	Press LK3 +  +   to access the Memory Block.	
3	Enter data using the dial pad. <b>Note:</b> Use the following to enter data: <ul style="list-style-type: none"> <li> to move the cursor left</li> <li> to move the cursor right</li> <li> ~  to enter numeric data</li> <li> to go to the next CO/PBX Line No.</li> </ul>	<b>Default Values</b> Not Specified
4	Press  to write the data.	
5	Press  to go back on-line.	

## Related Programming

M.B. Number	Memory Block Name
<b>3-04</b>	Trunk-to-Trunk Transfer Yes/No Selection
<b>3-05</b>	Trunk Incoming Answer Mode Selection

# CO/PBX Ringing Variation Selection

## General Description

Use this Memory Block to specify a ringing tone (Low, Medium, or High) for each CO/PBX line.

## Display

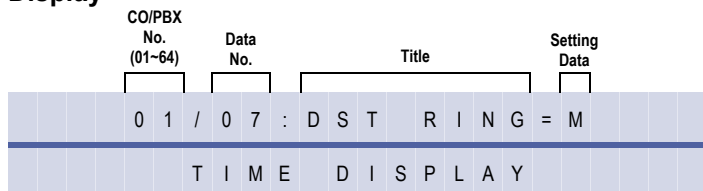







*System Mode*  
**3**  
*Submode*  
**—**  
*Data No.*  
**07**  
*PC Programming*  
 + BCT

## Settings

LK 1	LK 2	LK 3	LK 4
Medium (M)	Low (L)	High (H)	
LK 5	LK 6	LK 7	LK 8

The shaded area indicates the default setting.

## Programming Procedures

- 1 Go off-line.
- 2 Press LK3 +  +   to access the Memory Block.
- 3 Press the corresponding CO/PBX line key to change the data option.  
**Note:** Use the following when entering data:  
 to go to the next CO/PBX Line No.
- 4 Press  to write the data.
- 5 Press  to go back on-line.

## Related Programming

M.B. Number	Memory Block Name
1-1-28	Distinctive Ringing by Telephone or CO Selection



1. This Memory Block is not applicable if Telephone is selected in Memory Block , 1-1-28 , Distinctive Ringing by Telephone or CO Selection.
2. High, medium, or low ringing tone follows when transferring calls.

# CO External Source Selection

## General Description

Use this Memory Block to specify which CO Trunk is to have an External Music Source connected. A powered LIU must be used for Music Source Input. (Refer to the System Hardware Manual for details).

## Display

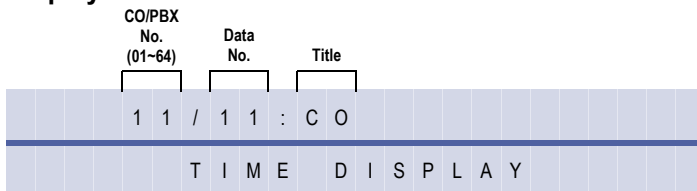







*System Mode*  
**3**  
*Submode*  
**—**  
*Data No.*  
**11**  
*PC Programming*  
 + BCT

## Settings

LK 1	LK 2	LK 3	LK 4
CO	Ext Source		
LK 5	LK 6	LK 7	LK 8

The shaded area indicates the default setting.

## Programming Procedures

- 1 Go off-line.
- 2 Press LK3 +  +   to access the Memory Block.
- 3 Press the corresponding CO/PBX line key to change the data option.  
**Note:** Use the following when entering data:  
 to go to the next CO/PBX Line No.
- 4 Press  to write the data.
- 5 Press  to go back on-line.

## Related Programming

M.B. Number	Memory Block Name
3-12	CO Hold Melody Selection (CO)

## N

1. This is also used for Tie lines.
2. When CO is set for EXT SOURCE and left in a trunk group, that CO is skipped in dialling access of the trunk group.

# CO Hold Melody Selection (CO)

*System Mode*  
**3**

*Submode*  
—

*Data No.*  
**12**

*PC Programming*  
 + BCT

## General Description

Use this Memory Block assigns CO Trunks to the CO Music Source inputs set in Memory Block, 3-11.

## Display

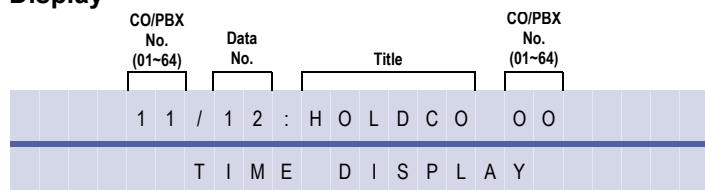









## Settings

LK 1	LK 2	LK 3	LK 4
CO	Ext Source		
LK 5	LK 6	LK 7	LK 8

The shaded area indicates the default setting.

## Programming Procedures

1	Go off-line.
2	Press LK3 +  +   to access the Memory Block.
3	Enter data using the Dial Pad. <b>Note:</b> Use the following when entering data:  to move the cursor to the left  to move the cursor to the right  to go to the next CO/PBX Line No. <b>Setting Data</b> 00 = Melody 10 01~64 = CO/PBX Line No. set in MB , 3-11
4	Press  to write the data.
5	Press  to go back on-line.

## Related Programming

M.B. Number	Memory Block Name
1-4-17	Automated Attendant Delay Announcement Hold Tone Selection
1-8-09	Music on Hold Pattern Selection
1-8-31	Hold Tone Source Selection
3-11	CO External Source Selection
4-66	ACD Plus Hold Tone Selection

**Example:**

Input C05 at MB3-11 (C05 = Ext Source)

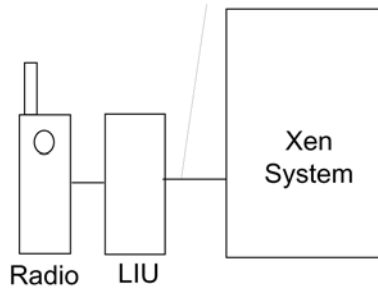

CO8 requires music at CO5 MB3-12 (CO8 Hold CO5)

# Tie/DID Line Type Assignment

## General Description

Use this Memory Block to assign the method of loop supervision to be used for each Trunk associated with a Tie line.

## Display

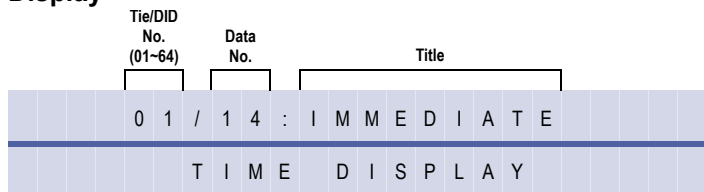

*System Mode*  
**3**

*Submode*  
—

*Data No.*  
**14**







*PC Programming*  
 + ALT

## Settings

LK 1	LK 2	LK 3	LK 4
2nd Dial Tone	Immediate	Delayed	Wink Start
LK 5	LK 6	LK 7	LK 8

The shaded area indicates the default setting.

## Programming Procedures

- 1 Go off-line.
- 2 Press LK3 +  +   to access the Memory Block.
- 3 Press the corresponding CO/PBX line key to change the data option.  
**Note:** Use the following to enter data:  
 to go to the next CO/PBX Port No.
- 4 Press  to write the data.
- 5 Press  to go back on-line.

## Related Programming

M.B. Number	Memory Block Name
<b>3-92</b>	Trunk (Installed, DP/DTMF) Selection

# N

1. Line keys 1~4 correspond to the following methods of loop supervision:
  - 1 = Second Dial Tone
  - 2 = Immediate Start
  - 3 = Delay Dial
  - 4 = Wink Start
2. If a second dial tone is selected, the distant system provides the dial tone.
3. If Immediate, Delay, or Wink Start is selected, the local system provides the dial tone.

# Trunk DTMF Duration/ Interdigit Selection

## General Description

Use this Memory Block to specify the tone duration and interdigit time of dual-tone multi-frequency (DTMF) signals.

## Display

CO/PBX No. (01-64)	Data No.	Title	Setting Data
01	15	MF	60 / 80
T I M E D I S P L A Y			

## Settings

LK 1		LK 2		LK 3		LK 4	
D.D.	I.T.	D.D.	I.T.	D.D.	I.T.	D.D.	I.T.
60 ms.	70 ms.	60 ms.	80 ms	110 ms	80 ms	160 ms.	80 ms
LK 5		LK 6		LK 7		LK 8	
D.D.	I.T.	D.D.	I.T.	D.D.	I.T.	D.D.	I.T.
210 ms	80 ms	410 ms	100 ms	610 ms	100 ms	810 ms	190 ms

The shaded area indicates the default setting.

## Programming Procedures

1	Go off-line.
2	Press LK3 +  +   to access the Memory Block.
3	Press the corresponding CO/PBX line key to change the data option. <b>Note:</b> Use the following to enter data: = Next CO/PBX Line No.
4	Press  to write the data.
5	Press  to go back on-line.

## Related Programming

M.B. Number	Memory Block Name
3-92	Trunk (Installed, DP/DTMF) Selection

System Mode  
**3**

Submode  
—

Data No.  
**15**

PC Programming  
 + BCT

# N

This is also used for Tie lines.

# Tie Line Prepause Time Selection

*System Mode*  
**3**  
*Submode*  
**—**  
*Data No.*  
**16**  
*PC Programming*  
 + **ALM**

## General Description

Use this Memory Block to specify the time (prepause) when the originating side becomes able to send dial pulse or dual-tone multi-frequency (DTMF) to the distant system.

## Display

CO/PBX No. (01-64)	Data No.	Title	Setting Data	Page No.
01	16	PRE	0	1
T I M E D I S P L A Y				

## Settings

### (Page 1)









LK 1	LK 2	LK 3	LK 4
0 sec.	0.5 sec.	1.0 sec.	1.5 sec.
LK 5	LK 6	LK 7	LK 8
2.0 sec.	3.0 sec.	4.0 sec.	5.0 sec.

### (Page 2)

LK 1	LK 2	LK 3	LK 4
6.0 sec.	7.0 sec.	8.0 sec.	9.0 sec.
LK 5	LK 6	LK 7	LK 8
10.0 sec.	11.0 sec.	12.0 sec.	13.0 sec.

The shaded area indicates the default setting.

## Programming Procedures

1	Go off-line.
2	Press LK3 +  +   to access the Memory Block.
3	Press the corresponding CO/PBX line key to change the data option. <b>Note:</b> The following to enter data:  to go to the next page  to go to the previous page  to go to the next CO/PBX Line No.
4	Press  to write the data.
5	Press  to go back on-line.

## Related Programming

No related programming is necessary for this Memory Block.



Prepause time differs according to the acknowledgment signalling method.



# Tie Line Answer Detect Time Selection

## General Description

Use this Memory Block to specify the duration between the time when the receiving Xen system answers (off-hook) and the time when it is recognised as an answer.

## Display

CO/PBX No. (01-64)	Data No.	Title	Setting Data	Page No.
01	17	PRE	390	1
T I M E D I S P L A Y				

System Mode  
**3**

Submode  
—

Data No.  
**17**

PC Programming



## Settings

### (Page 1)

LK 1	LK 2	LK 3	LK 4
0 ms.	130 ms.	260 ms.	390 ms.
LK 5	LK 6	LK 7	LK 8
520 ms.	650 ms.	780 ms.	910 ms.

### (Page 2)

LK 1	LK 2	LK 3	LK 4
1040 ms.	1170 ms.	1300 ms.	1430 ms.
LK 5	LK 6	LK 7	LK 8
1560 ms.	1690 ms.	1820 ms.	1950 ms.

The shaded area indicates the default setting.

## Programming Procedures

<b>1</b>	Go off-line.
<b>2</b>	Press LK3 +  +  +  to access the Memory Block.
<b>3</b>	Press the corresponding CO/PBX line key to change the data option. <b>Note:</b> The following are used when entering data: <div style="margin-left: 20px;">  to go to the next page   to go to the previous page   to go to the next CO/PBX Line No.                 </div>
<b>4</b>	Press  to write the data.
<b>5</b>	Press  to go back on-line.

## Related Programming

No related programming is necessary for this Memory Block.

# N

Answering a call may not be possible if the CO answer detect time is too long.

# Tie Line Release Detect Time Selection

## General Description

Use this Memory Block to specify the duration between the time when the circuit disconnection is detected on the Tie line on the distant system side and the time when it is recognised as Tie line release.

## Display

CO/PBX No. (01-64)	Data No.	Title	Setting Data	Page No.
01	18	RLS	260	1
T I M E D I S P L A Y				

System Mode  
**3**

Submode  
—

Data No.  
**18**

PC Programming  
 + **ALM**

## Settings

### (Page 1)









LK 1	LK 2	LK 3	LK 4
0 ms.	130 ms.	260 ms.	390 ms.
LK 5	LK 6	LK 7	LK 8
520 ms.	650 ms.	780 ms.	910 ms.

The shaded area indicates the default setting.

### (Page 2)

LK 1	LK 2	LK 3	LK 4
1040 ms.	1170 ms.	1300 ms.	1430 ms.
LK 5	LK 6	LK 7	LK 8
1560 ms.	1690 ms.	1820 ms.	1950 ms.

## Programming Procedures

1	Go off-line.
2	Press LK3 +  +   to access the Memory Block.
3	Press the corresponding CO/PBX line key to change the data option. <b>Note:</b> The following are used when entering data:  to go to the next page  to go to the previous page  to go to the next CO/PBX Line No.
4	Press  to write the data.
5	Press  to go back on-line.

## Related Programming

No related programming is necessary for this Memory Block.

---

# N

1. Specify distinguishing circuit release from on-hook, noise, and temporary interruption. There are four probable situations for Tie line release detection:
  - ④ Called side hangs up first. The circuit is released 92 ms. + specified time after the other party disconnects the call.
  - ④ Called side hangs up second. The circuit is released when the specified time has elapsed after the other party hangs up.
  - ④ Originating side hangs up first. The circuit is released 92 ms. + specified time after the other party hangs up.
  - ④ Originating side hangs up second. The circuit is released when the specified time has elapsed after the other party hangs up.

# Tie Line/CO/PBX Incoming Signal Detect Time Selection

## General Description

Use this Memory Block to specify the duration between the time when the incoming signal from another system is detected and the time when the acknowledgment signal is sent out.

## Display

Data No.	Title	Setting Data	Page No.
0 1 / 1 9	: I N C	0 3	1
T I M E D I S P L A Y			

*System Mode*  
**3**

*Submode*  
—

*Data No.*  
**19**

*PC Programming*  
 + BCT

## Settings

### (Page 1) In Wink Start Method

LK 1	LK 2	LK 3	LK 4
0 ms. (00)	130 ms. (01)	260 ms. (02)	390 ms. (03)
LK 5	LK 6	LK 7	LK 8
520 ms. (04)	650 ms. (05)	780 ms. (06)	910 ms. (07)

### (Page 2)

LK 1	LK 2	LK 3	LK 4
1040 ms. (08)	1170 ms. (09)	1300 ms. (10)	1430 ms. (11)
LK 5	LK 6	LK 7	LK 8
1560 ms. (12)	1690 ms. (13)	1820 ms. (14)	1950 ms. (15)

### (Page 1) In Delay Method

LK 1	LK 2	LK 3	LK 4
0 ms. (00)	30 ms. (01)	60 ms. (02)	90 ms. (03)
LK 5	LK 6	LK 7	LK 8
120 ms. (04)	150 ms. (05)	180 ms. (06)	210 ms. (07)

### (Page 2)

LK 1	LK 2	LK 3	LK 4
240 ms. (08)	270 ms. (09)	300 ms. (10)	330 ms. (11)
LK 5	LK 6	LK 7	LK 8
360 ms. (12)	390 ms. (13)	420 ms. (14)	450 ms. (15)

The shaded area indicates the default setting.









### (Page 1) In COI

LK 1	LK 2	LK 3	LK 4
50 ms. (00)	100 ms. (01)	150 ms (02)	200 ms. (03)
LK 5	LK 6	LK 7	LK 8
250 ms. (04)	300 ms. (05)	350 ms. (06)	400 ms. (07)

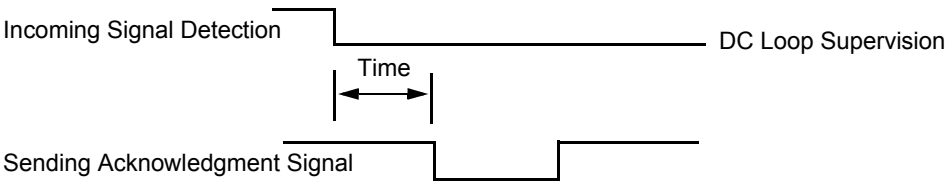
### (Page 2)

LK 1	LK 2	LK 3	LK 4
450 ms. (08)	500 ms. (09)	550 ms. (10)	600 ms. (11)
LK 5	LK 6	LK 7	LK 8
650 ms. (12)	700 ms. (13)	750 ms. (14)	800 ms. (15)

**Programming Procedures**

1	Go off-line.
2	Press LK3 +  +   to access the Memory Block.
3	<p>Press the corresponding CO/PBX line key to change the data option.</p> <div style="border: 1px solid black; padding: 5px; width: fit-content;">Receiving Side</div>  <p><b>Note:</b> Use the following to enter data:</p> <ul style="list-style-type: none"> <li> to go to the next page</li> <li> to go to the previous page</li> <li> to go to the next CO/PBX Line No.</li> </ul>
4	Press  to write the data.
5	Press  to go back on-line.

**Related Programming**

M.B. Number	Memory Block Name
3-14	Tie/DID Line Type Assignment

**N**

For the second dial tone method and the immediate method, the time is fixed at 30 ms.

# Tie Line Loop Off-Guard Time Selection

*System Mode*  
**3**  
*Submode*  
**—**  
*Data No.*  
**20**  
*PC Programming*  
 + **ALM**

## General Description

Use this Memory Block to assign loop off-guard protection to prevent noise that may cause the system to be unable to answer an incoming Tie line.

## Display

CO/PBX No. (01-64)	Data No.	Title	Setting Data	Page No.
01	20	LOOP	2.0	1
T I M E D I S P L A Y				

## Settings

### (Page 1)









LK 1	LK 2	LK 3	LK 4
0 sec.	0.5 sec.	1.0 sec.	1.5 sec.
LK 5	LK 6	LK 7	LK 8
2.0 sec.	3.0 sec.	4.0 sec.	5.0 sec.

The shaded area indicates the default setting.

### (Page 2)

LK 1	LK 2	LK 3	LK 4
6.0 sec.	7.0 sec.	8.0 sec.	9.0 sec.
LK 5	LK 6	LK 7	LK 8
10.0 sec.	11.0 sec.	12.0 sec.	13.0 sec.

## Programming Procedures

1	Go off-line.
2	Press LK3 +  +   to access the Memory Block.
3	Press the corresponding CO/PBX line key to change the data option. <b>Note:</b> The following are used when entering data:  to go to the next page  to go to the previous page  to go to the next CO/PBX Line No.
4	Press  to write the data.
5	Press  to go back on-line.

## Related Programming

No related programming is necessary for this Memory Block.



1. Assign a loop off-guard time to eliminate the possibility of system malfunction caused by noise when going off-hook to answer a call from another system on a Tie line call.
2. The system ignores any noise that may be detected during the time specified in this Memory Block.

# Tie Line Length of Wink Signal Selection

System Mode  
**3**

Submode  
—

Data No.  
**21**

PC Programming

 + **ALM**

## General Description

Use this Memory Block to specify the duration of a wink pulse that is sent to another system.

## Display

CO/PBX No. (01-64)	Data No.	Title	Setting Data	Page No.
0 1 / 2 1	:	W I N K 1 8 0		1
T I M E D I S P L A Y				

## Settings

(Page 1)



LK 1	LK 2	LK 3	LK 4
30 ms.	60 ms.	90 ms.	120 ms.
LK 5	LK 6	LK 7	LK 8
150 ms.	180 ms.	210 ms.	240 ms.

(Page 2)

LK 1	LK 2	LK 3	LK 4
270 ms.	300 ms.	330 ms.	360 ms.
LK 5	LK 6	LK 7	LK 8
390 ms.	420 ms.	450 ms.	480 ms.



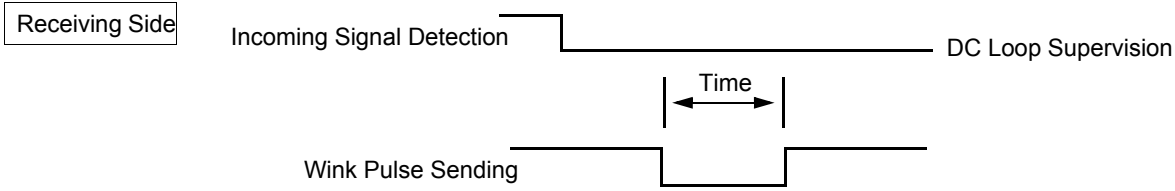

The shaded area indicates the default setting.

## Programming Procedures

- 1 Go off-line.
- 2 Press LK3 +  +   to access the Memory Block.
- 3 Press the corresponding CO/PBX line key to change the data option.
 



**Note:** Use the following to enter data:

  -  to go to the next page
  -  to go to the previous page
  -  to go to the next CO/PBX Line No.
- 4 Press  to write the data.
- 5 Press  to go back on-line.

### Related Programming

No related programming is necessary for this Memory Block.

---

**N**

Specify the Wink Start method in Memory Block , 3-24 , Tie Line Incoming Interdigit Timeout Selection.



# Tie Line Length of Delay Signal Selection

System Mode  
**3**

Submode  
—

Data No.  
**22**

PC Programming

 + ALM

## General Description

Use this Memory Block to specify the time a delay pulse is sent to another system.

## Display

CO/PBX No. (01-64)	Data No.	Title	Setting Data	Page No.
0 1 /	2 2 :	D E L Y	3 0 0	1
T I M E D I S P L A Y				

## Settings

(Page 1)



LK 1	LK 2	LK 3	LK 4
0 ms.	300 ms.	600 ms.	900 ms.
LK 5	LK 6	LK 7	LK 8
1200 ms.	1500 ms.	1800 ms.	2100 ms.

(Page 2)

LK 1	LK 2	LK 3	LK 4
2400 ms.	2700 ms.	3000 ms.	3300 ms.
LK 5	LK 6	LK 7	LK 8
3600 ms.	3900 ms.	4200 ms.	4500 ms.

The shaded area indicates the default setting.



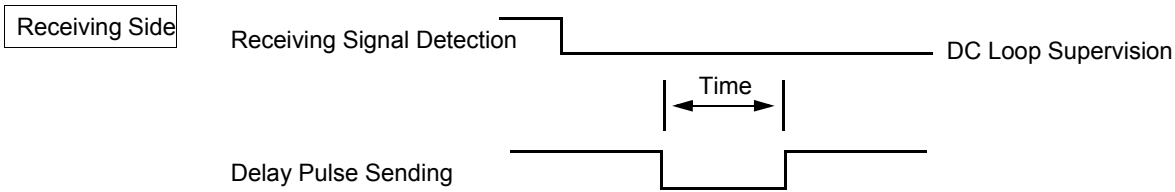

## Programming Procedures

- 1 Go off-line.
- 2 Press LK3 +  +   to access the Memory Block.
- 3 Press the corresponding CO/PBX line key to change the data option.
 



The diagram shows a signal flow from the Receiving Side. It includes a 'Receiving Signal Detection' pulse, a 'Delay Pulse Sending' pulse, and a 'DC Loop Supervision' signal. A double-headed arrow labeled 'Time' indicates the duration of the delay pulse.

**Note:** Use the following to enter data:

  -  to go to the next page
  -  to go to the previous page
  -  to go to the next CO/PBX Line No.
- 4 Press  to write the data.
- 5 Press  to go back on-line.

### Related Programming

No related programming is necessary for this Memory Block.

---

**N**

Specify the Delay Method in Memory Block , 3-14 , Tie/DID Line Type Assignment.

# Tie Line Incoming Interdigit Timeout Selection

## General Description

Use this Memory Block to specify a time interval during the incoming call detection process so that if an address signal is not received within a specified time, an error tone is returned to the other system.

## Display

CO/PBX No. (01-64)	Data No.	Title	Setting Data	Page No.
0 1 /	2 4 :	I N C O M	6 s	1
T I M E D I S P L A Y				

### (Page 1)

LK 1	LK 2	LK 3	LK 4
No Limit	1 sec.	2 sec.	3 sec.
LK 5	LK 6	LK 7	LK 8
4 sec.	5 sec.	6 sec.	7 sec.

### (Page 2)

LK 1	LK 2	LK 3	LK 4
8 sec.	9 sec.	10 sec.	11 sec.
LK 5	LK 6	LK 7	LK 8
12 sec.	13 sec.	14 sec.	15 sec.

The shaded area indicates the default setting.

System Mode  
**3**









Submode  
—

Data No.  
**24**

PC Programming

 + ALM

## Programming Procedures

- 1 Go off-line.
- 2 Press LK3 +  +   to access the Memory Block.
- 3 Press the corresponding CO/PBX line key to change the data option.  
**Note:** Use the following enter data:  
 to go to the next page  
 to go to the previous page  
 to go to the next CO/PBX Line No.
- 4 Press  to write the data.
- 5 Press  to go back on-line.

## Related Programming

No related programming is necessary for this Memory Block.

**N**

A timeout occurs when:

- ① A dial pulse is not received within the time specified by this Memory Block after the receiving side detects the off-hook signal.
- ① The next dial pulse is not received within the time specified by this Memory Block after the receiving side detects (receives) a dial pulse.

# Tie Line Wink/Delay Signal Detect Timeout Selection

System Mode  
**3**

Submode  
—

Data No.  
**25**

PC Programming



## General Description

Use this Memory Block to specify a maximum time for receiving an acknowledgment signal from a distant system before sending a busy tone.

## Display

CO/PBX No. (01-64)	Data No.	Title	Setting Data	Page No.
01	25	DTECT	7 s	1
T I M E D I S P L A Y				

## Settings

### (Page 1)

LK 1	LK 2	LK 3	LK 4
No Limit	1 sec.	2 sec.	3 sec.
LK 5	LK 6	LK 7	LK 8
4 sec.	5 sec.	6 sec.	7 sec.

### (Page 2)

LK 1	LK 2	LK 3	LK 4
8 sec.	9 sec.	10 sec.	11 sec.
LK 5	LK 6	LK 7	LK 8
12 sec.	13 sec.	14 sec.	15 sec.

The shaded area indicates the default setting.

## Programming Procedures

<b>1</b>	Go off-line.
<b>2</b>	Press LK3 +  +   to access the Memory Block.
<b>3</b>	<p>Press the corresponding CO/PBX line key to change the data option.</p> <div style="display: flex; align-items: center;"> <div style="border: 1px solid black; padding: 2px; margin-right: 10px;">Originating</div> <div style="margin-right: 20px;">Sending an Outgoing</div> </div> <p><b>Note:</b> Use the following to enter data:</p> <ul style="list-style-type: none"> <li> to go to the next page</li> <li> to go to the previous page</li> <li> to go to the next CO/PBX Line No.</li> </ul>
<b>4</b>	Press  to write the data.
<b>5</b>	Press  to go back on-line.

### Related Programming

No related programming is necessary for this Memory Block.

---

**N**

If the acknowledgment signal is not received within a predetermined time after an outgoing signal is sent to the other system, a busy tone is sent to the telephone.

# Tie Line Dial Tone Selection

### General Description

Use this Memory Block to specify whether or not to send a dial tone to the distant system.

### Display

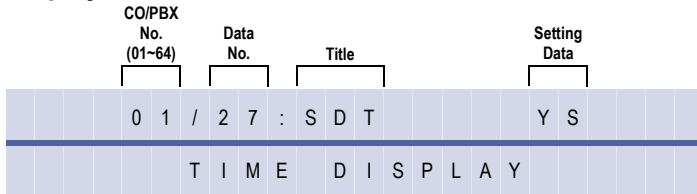

System Mode  
**3**

Submode  
—

Data No.  
**27**









PC Programming  
 + ALT

### Settings

LK 1	LK 2	LK 3	LK 4
No	Yes		
LK 5	LK 6	LK 7	LK 8

The shaded area indicates the default setting.

### Programming Procedures

- 1 Go off-line.
- 2 Press LK3 +  +   to access the Memory Block.
- 3 Press the corresponding CO/PBX line key to change the data option.  
**Note:** Use the following to enter data:  
 to go to the next page  
 to go to the previous page  
 to go to the next CO/PBX Line No.
- 4 Press  to write the data.
- 5 Press  to go back on-line.

### Related Programming

M.B. Number	Memory Block Name
<b>3-14</b>	Tie/DID Line Type Assignment

# Tie Line Reorder Tone Selection

## General Description

Use this Memory Block to specify whether or not to send a reorder tone to the originating station when the number of a distant system is used to originate a call over a Tie line.

## Display

CO/PBX No. (01-64)	Data No.	Title	Setting Data
01	28	ROT	YS
T I M E D I S P L A Y			





*System Mode*  
**3**  
*Submode*  
**—**  
*Data No.*  
**28**  
*PC Programming*  
 + ALT



## Settings

LK 1	LK 2	LK 3	LK 4
Not Sending	Sending		
LK 5	LK 6	LK 7	LK 8

The shaded area indicates the default setting.

## Programming Procedures

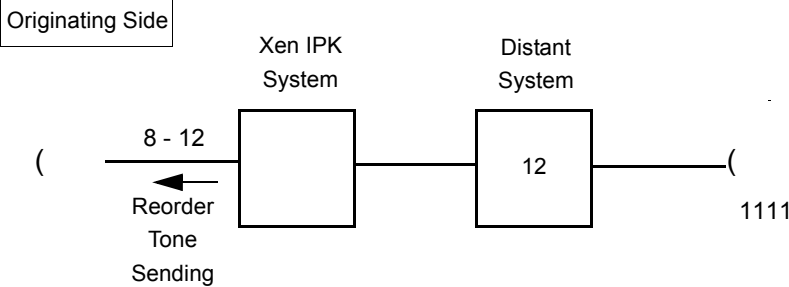
- Go off-line.
- Press LK3 +  +   to access the Memory Block.
- Press the corresponding CO/PBX line key to change the data option.  
**Note:** Use the following to enter data:  
 to go to the next CO/PBX Line No.
 

- Press  to write the data.
- Press  to go back on-line.

## Related Programming

M.B. Number	Memory Block Name
3-14	Tie/DID Line Type Assignment



# Trunk Internal Transmit Pad Selection

## General Description

This Memory Block specifies a volume level for calls originated from the extensions of a local system to a distant system.

## Display

CO/PBX No. (01-64)	Data No.	Title	Setting Data	Page No.
01	29	PADIT	8	1
T I M E D I S P L A Y				

System Mode  
**3**

Submode  
—

Data No.  
**29**

PC Programming  
 + BCT

## Settings

### (Page 1)









LK 1	LK 2	LK 3	LK 4
2 dB	4 dB	6 dB	8 dB
LK 5	LK 6	LK 7	LK 8
12 dB	16 dB	3 dB	-3 dB

### (Page 2)

LK 1	LK 2	LK 3	LK 4
0 dB			
LK 5	LK 6	LK 7	LK 8

The shaded area indicates the default setting.

## Programming Procedures

<b>1</b>	Go off-line.
<b>2</b>	Press LK3 +  +   to access the Memory Block.
<b>3</b>	Press the corresponding CO/PBX line key to change the data option. <b>Note:</b> Use the following to enter data: <div style="margin-left: 20px;">  to go to the next page   to go to the previous page   to go to the next CO/PBX Line No.                 </div>
<b>4</b>	Press  to write the data.
<b>5</b>	Press  to go back on-line.

## Related Programming

No related programming is necessary for this Memory Block.

---

# N

1. The Xen system divides the connections into the following patterns:

(Specify the sending and receiving levels of each pattern for each of the trunks.)

Pattern A (Intercom Mode)	Connections established between the intercom stations of the local system and trunks.
— Sending level	
— Receiving level	(To be specified in this Memory Block.)
Pattern B (Tandem Mode)	Connections established between two systems, with the local system as a tandem system.
— Sending level	
— Receiving level	

2. The Memory Block applies to Tie lines, DID and Basic Rate Interface (BRI) trunks.

# Trunk Internal Receive Pad Selection

## General Description

Use this Memory Block to specify a volume level for calls coming to extensions of a local system from a distant system.

## Display

CO/PBX No. (01-64)	Data No.	Title	Setting Data	Page No.
01	30	PADIR	8	1
T I M E D I S P L A Y				

System Mode  
**3**

Submode  
—

Data No.  
**30**

PC Programming  
 + BCT

## Settings

### (Page 1)









LK 1	LK 2	LK 3	LK 4
2 dB	4 dB	6 dB	8 dB
LK 5	LK 6	LK 7	LK 8
12 dB	16 dB	3 dB	-3 dB

### (Page 2)

LK 1	LK 2	LK 3	LK 4
0 dB			
LK 5	LK 6	LK 7	LK 8

The shaded area indicates the default setting.

## Programming Procedures

- 1 Go off-line.
- 2 Press LK3 +  +   to access the Memory Block.
- 3 Press the corresponding CO/PBX line key to change the data option.  
**Note:** Use the following to enter data:  
 to go to the next page  
 to go to the previous page  
 to go to the next CO/PBX Line No.
- 4 Press  to write the data.
- 5 Press  to go back on-line.

## Related Programming

No related programming is necessary for this Memory Block.

---

# N

1. The Xen system divides the connections into the following patterns:

(Specify the sending and receiving levels of each pattern for each of the trunks.)

Pattern A (Intercom Mode)	Connections established between the intercom stations of the local system and trunks.
— Sending level	
— Receiving level	(To be specified in this Memory Block.)
Pattern B (Tandem Mode)	Connections established between two systems, with the local system as a tandem system.
— Sending level	
— Receiving level	

2. The Memory Block applies to Tie lines, DID and Basic Rate Interface (BRI) trunks.

# Trunk External Transmit Pad Selection

## General Description

Use this Memory Block to specify a volume level for tandem calls through a local system to two distant systems.

## Display

CO/PBX No. (01-64)	Data No.	Title	Setting Data	Page No.
01	31	PAD	ET	01
T I M E D I S P L A Y				

System Mode  
**3**

Submode  
—

Data No.  
**31**

PC Programming  
 + BCT

## Settings

### (Page 1)









LK 1	LK 2	LK 3	LK 4
2 dB	4 dB	6 dB	8 dB
LK 5	LK 6	LK 7	LK 8
12 dB	16 dB	3 dB	-3 dB

### (Page 2)

LK 1	LK 2	LK 3	LK 4
0 dB			
LK 5	LK 6	LK 7	LK 8

The shaded area indicates the default setting.

## Programming Procedures

- 1 Go off-line.
- 2 Press LK3 +  +   to access the Memory Block.
- 3 Press the corresponding CO/PBX line key to change the data option.  
**Note:** Use the following to enter data:  
 to go to the next page  
 to go to the previous page  
 to go to the next CO/PBX Line No.
- 4 Press  to write the data.
- 5 Press  to go back on-line.

## Related Programming

No related programming is necessary for this Memory Block.

# N

1. The Xen system divides the connections into the following patterns:

(Specify the sending and receiving levels of each pattern for each of the trunks.)

	Pattern A (Intercom Mode)	Connections established between the intercom stations of the local system and trunks.
—	Sending level	
—	Receiving level	

	Pattern B (Tandem Mode)	Connections established between two systems, with the local system as a tandem system.
—	Sending level	(To be specified in this Memory Block.)
—	Receiving level	

2. The Memory Block applies to Tie lines, DID and ISDN trunks.

# Trunk External Receive Pad Selection

## General Description

Use this Memory Block to specify a volume level for tandem calls through a local system to two distant systems.

## Display

CO/PBX No. (01-64)	Data No.	Title	Setting Data	Page No.
01	32	PAD ER	0	1
T I M E D I S P L A Y				

System Mode  
**3**

Submode  
—

Data No.  
**32**

PC Programming  
 + BCT

## Settings

### (Page 1)









LK 1	LK 2	LK 3	LK 4
2 dB	4 dB	6 dB	8 dB
LK 5	LK 6	LK 7	LK 8
12 dB	16 dB	3 dB	-3 dB

### (Page 2)

LK 1	LK 2	LK 3	LK 4
0 dB			
LK 5	LK 6	LK 7	LK 8

The shaded area indicates the default setting.

## Programming Procedures

- 1 Go off-line.
- 2 Press LK3 +  +   to access the Memory Block.
- 3 Press the corresponding CO/PBX line key to change the data option.  
**Note:** Use the following to enter data:  
 to go to the next page  
 to go to the previous page  
 to go to the next CO/PBX Line No.
- 4 Press  to write the data.
- 5 Press  to go back on-line.

## Related Programming

No related programming is necessary for this Memory Block.

# N

1. The Xen system divides the connections into the following patterns:

(Specify the sending and receiving levels of each pattern for each of the trunks.)

Pattern A (Intercom Mode)	Connections established between the intercom stations of the local system and trunks.
— Sending level	
— Receiving level	

Pattern B (Tandem Mode)	Connections established between two systems, with the local system as a tandem system.
— Sending level	
— Receiving level	

(To be specified in this Memory Block.)

2. The Memory Block applies to Tie lines, DID and ISDN trunks.



# Disconnect Recognition Time Selection

## General Description

Use this Memory Block to specify the minimum time for a disconnected circuit to be accessed again.

## Display

CO/PBX No. (01-64)	Data No.	Title	Setting Data	Page No.
01	33	DIST	0.3	1
T I M E D I S P L A Y				

System Mode  
**3**

Submode  
—

Data No.  
**33**

PC Programming

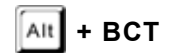

## Settings

### (Page 1)

LK 1	LK 2	LK 3	LK 4
0 sec.	.1 sec.	.2 sec.	.3 sec.
LK 5	LK 6	LK 7	LK 8
.4 sec.	.5 sec.	.6 sec.	.7 sec.

### (Page 2)

LK 1	LK 2	LK 3	LK 4
.8 sec.	.9 sec.	1.0 sec.	1.1 sec.
LK 5	LK 6	LK 7	LK 8
1.2 sec.	1.3 sec.	1.4 sec.	1.5 sec.

The shaded area indicates the default setting.

## Programming Procedures

<b>1</b>	Go off-line.
<b>2</b>	Press LK3 +  +   to access the Memory Block.
<b>3</b>	Press the corresponding CO/PBX line key to change the data option. <b>Note:</b> Use the following to enter data: to go to the next page to go to the previous page to go to the next CO/PBX Line No.
<b>4</b>	Press  to write the data.
<b>5</b>	Press  to go back on-line.

## Related Programming

No related programming is necessary for this Memory Block.



When a call origination on a CO/PBX line or Tie line is interrupted or dropped while in progress, and an attempt is made to re seize the line, the seized line must be disconnected and cleared before it can be accessed again.

# Automated Attendant Message to Trunk Selection

## General Description





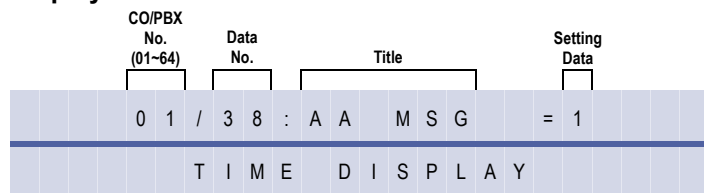

Use this Memory Block to assign the Automated Attendant Message per-CO/PBX Trunk. When the Automated Attendant Message is assigned to each CO/PBX Trunk, the system automatically answers the incoming call and sends an Automated Attendant Message to the calling party.

## Display



*System Mode*  
**3**  
*Submode*  
**—**  
*Data No.*  
**38**  
*PC Programming*  
 + AU

## Programming Procedures

1	Go off-line.	
2	Press LK3 +  +   to access the Memory Block.	
3	Enter data using the dial pad. <b>Setting Data:</b> 1~8 Automated Attendant Message 1~8 <b>Note:</b> Use the following to enter data:  : Next CO/PBX Line No.	<b>Default Values</b> Message 1
4	Press  to write the data.	
5	Press  to go back on-line.	

## Related Programming

No related programming is necessary for this Memory Block.



The attendant telephone position must dial an Access Code to activate this feature.

# Automatic Release Selection

## General Description

This Memory Block specifies whether or not the system is to release a trunk used to make an outgoing call when the called party hangs. Selecting Yes will result in the system disconnecting the trunk upon the outside party hanging up. Selecting No will result in the trunk being held upon the outside party hanging up, the trunk only being released when the KTS extension hangs up.

## Display

CO/PBX No. (01-64)	Data No.	Title	Setting Data
01	39	AUTORLS	=YS
TIME DISPLAY			

## Settings

LK1	LK2	LK3	LK4
No	Yes		
LK5	LK5	LK7	LK8

The shaded area indicates the default setting.

## Programming Procedures

- 1 Go off-line.
- 2 Press LK3 + + to access the Memory Block.
- 3 Press the corresponding CO/PBX line key to change the data option
- 4 Press to write the data.
- 5 Press to go back on-line.

## Related Programming

No related programming is necessary for this Memory Block.

System Mode  
**3**

Submode  
—

Data No.  
**39**

PC Programming  
 + AU

# N

The attendant telephone position must dial an Access Code to activate this feature.

# ACD/UCD Delay Announcement Assignment

## General Description

Use this Memory Block to specify, per CO Port, whether or not ACD/UCD Delay Announcement is sent to the calling party for Day and/or Night Mode.

## Display

CO/PBX No. (01-64)	Data No.	Title	Setting Data
0 1 / 4 1	:	M S G D / N =	N N
T I M E D I S P L A Y			

System Mode  
**3**

Submode  
—

Data No.  
**41**







PC Programming  
 + BCT

## Settings

LK 1	LK 2	LK 3	LK 4
NN	YN	NY	YY
LK 5	LK 6	LK 7	LK 8

The shaded area indicates the default setting.

## Programming Procedures

<b>1</b>	Go off-line.															
<b>2</b>	Press LK3 +  +   to access the Memory Block.															
<b>3</b>	Press the corresponding CO/PBX line key to change the data option. <b>Note:</b> Use the following to enter data:  to go to the next CO/PPBX Line No. <b>Setting Data:</b>															
	<table border="1" style="width: 100%;"> <thead> <tr> <th>Line Key</th> <th>LCD Indication</th> <th>ACD/UCD Delay Announcement</th> </tr> </thead> <tbody> <tr> <td style="text-align: center;">1</td> <td style="text-align: center;">NN</td> <td style="text-align: center;">No</td> </tr> <tr> <td style="text-align: center;">2</td> <td style="text-align: center;">YN</td> <td style="text-align: center;">Day Only</td> </tr> <tr> <td style="text-align: center;">3</td> <td style="text-align: center;">NY</td> <td style="text-align: center;">Night Only</td> </tr> <tr> <td style="text-align: center;">4</td> <td style="text-align: center;">YY</td> <td style="text-align: center;">Day and Night</td> </tr> </tbody> </table>	Line Key	LCD Indication	ACD/UCD Delay Announcement	1	NN	No	2	YN	Day Only	3	NY	Night Only	4	YY	Day and Night
Line Key	LCD Indication	ACD/UCD Delay Announcement														
1	NN	No														
2	YN	Day Only														
3	NY	Night Only														
4	YY	Day and Night														
<b>4</b>	Press  to write the data.															
<b>5</b>	Press  to go back on-line.															

## Related Programming

M.B. Number	Memory Block Name
	Refer to <i>Chapter 2, Guide to Feature Programming.</i>

# DIT Assignment

## General Description





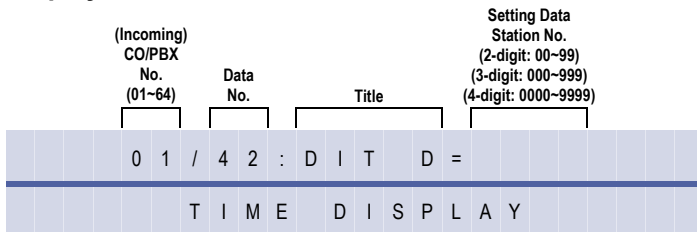



Use this Memory Block to independently assign a Day Mode direct trunk termination to a station.

## Display



*System Mode*  
**3**  
*Submode*  
**—**  
*Data No.*  
**42**  
*PC Programming*  
 + BCT

## Programming Procedures

<b>1</b>	Go off-line.	
<b>2</b>	Press LK3 +  +   to access the Memory Block.	
<b>3</b>	Enter data using the dial pad. <b>Note:</b> Use the following to enter data:  ~  to enter the numeric data  to go to the next CO/PBX Line No. Enter the following: Station No. (2-, 3-, or 4-digits 00~9999) CO Port No. (01~64)	<b>Default Values</b> No Assignment
<b>4</b>	Press  to write the data.	
<b>5</b>	Press  to go back on-line.	

## Related Programming

M.B. Number	Memory Block Name
<b>3-45</b>	ANA Assignment

# N

A trunk can terminate at only one station, but any number of trunks can terminate at the same station.

# ANA Assignment

## General Description

Use this Memory Block to assign a Night Mode Direct trunk termination to a station.

## Display

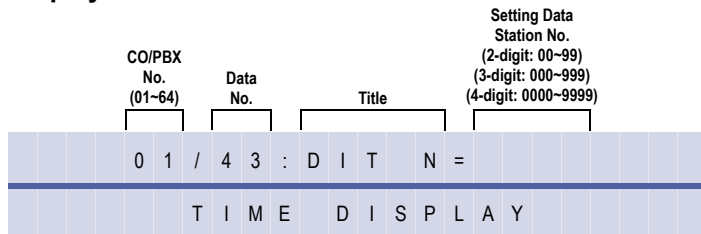

System Mode  
**3**  
Submode  
—  
Data No.  
**43**  
PC Programming  
 + AR

## Programming Procedures

1	Go off-line.	
2	Press LK3 +  +   to access the Memory Block.	
3	Enter data using the dial pad. <b>Note:</b> Use the following to enter data: to enter numeric data to go to the next CO/PBX Line No. Enter the following: Station No. (2-, 3-, or 4-digits 00~9999) CO Port No. (01~64)	<b>Default Values</b> No Assignment
4	Press  to write the data.	
5	Press  to go back on-line.	

## Related Programming

M.B. Number	Memory Block Name
<b>3-44</b>	DIT Assignment



A trunk can terminate at only one station, but any number of trunks can terminate at the same station.

# Caller ID Display Assignment for CO/PBX Line

## General Description

Use this Memory Block to assign one Multiline Terminal, per CO/PBX, line to display Caller ID Indication on incoming CO/PBX calls.

## Display

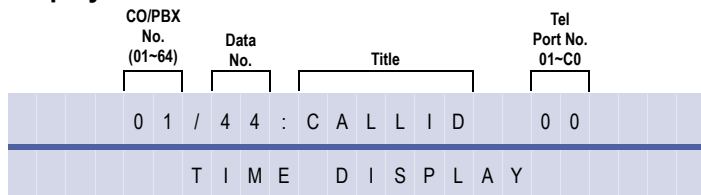









System Mode  
**3**

Submode  
—

Data No.  
**44**

PC Programming  
 + BCT

## Programming Procedures

1	Go off-line.	
2	Press LK3 +  +   to access the Memory Block.	
3	Enter data using the dial pad. <b>Note:</b> The following are used when entering data: <ul style="list-style-type: none"> <li> to move the cursor left</li> <li> to move the cursor right</li> <li> ~  to enter numeric data</li> </ul>	<b>Default Values</b> Not Specified
4	Press  to write the data.	
5	Press  to go back on-line.	

## Related Programming

M.B. Number	Memory Block Name
	Refer to <i>Chapter 2, Guide to Feature Programming.</i>

# N

To display Caller ID Indication for normal incoming CO calls and CAR incoming calls, both Caller ID Indication and Ring assignment must be assigned for the terminal in System Programming. A maximum of 15 Multiline Terminals can be assigned system-wide to display caller identification for normal incoming CO calls and CAR incoming calls using Memory Block , 1-1-78 , Caller ID Display Assignment for System Mode. A third Multiline Terminal can be assigned to display caller identification for normal incoming CO calls, per CO line, using this Memory Block.

# Live Recording Trunk Selection

## General Description

Use this Memory Block to specify, per Trunk, Live Recording Service Mode or No Live Recording Service Mode for Digital Voice Mail.

## Display

CO/PBX No. (01-64)	Data No.	Title	Setting Data
01	45	LIVEREC	NO
T I M E D I S P L A Y			

*System Mode*  
**3**

*Submode*  
—

*Data No.*  
**45**









*PC Programming*  
 + BCT

## Settings

LK 1	LK 2	LK 3	LK 4
No	Yes		
LK 5	LK 6	LK 7	LK 8

The shaded area indicates the default setting.

## Programming Procedures

1	Go off-line.	
2	Press LK3 +  +   to access the Memory Block.	
3	Press the corresponding CO/PBX line key to change the data option. <b>Note:</b> Use the following to enter data:  to move the cursor left  to move the cursor right  to enter numeric data  to go to the next CO/PBX Line No.	<b>Default Values</b> No
4	Press  to write the data.	
5	Press  to go back on-line.	

## Related Programming

M.B. Number	Memory Block Name
1-8-08	Class of Service (Station) Feature Selection 2



YES must be assigned for the Digital Voice Mail Live Recording feature for each trunk.



# ISDN Trunk Directory Number Assignment

System Mode  
**3**

Submode  
—

Data No.  
**52**

PC Programming



## General Description

Use this Memory Block to assign the Integrated Services Digital Network (ISDN) Directory Number.

## Display

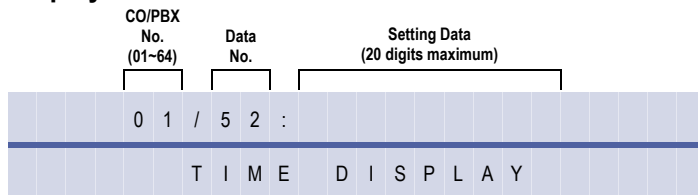

## Programming Procedures

<b>1</b>	Go off-line.
<b>2</b>	Press LK3 +  +   to access the Memory Block.
<b>3</b>	Enter Data using the Dial Pad: <b>Note:</b> Use the following to enter data: to move the cursor left to move the cursor right to enter numeric data to go to the next CO/PBX Line No.
<b>4</b>	Press  to write the data.
<b>5</b>	Press  to go back on-line.

## Related Programming

No related programming is necessary for this Memory Block.

**N**

1. If CFE feature is to be used, the GDN number must be set for BRI.
2. If DID is used in conjunction with PRI, do not assign any number to CO.
3. Enter the Area Code as part of directory number, e.g. Melbourne = 3xxxx xxxx

# Caller Name Indication Selection

*System Mode*  
**3**  
*Submode*  
**—**  
*Data No.*  
**53**  
*PC Programming*  
 + AI

## General Description

When an Caller ID number is detected, the IPK system can check the speed dialling buffer for a match. When a name is assigned to a matched number, the name can be displayed, when allowed by this assignment.

## Display

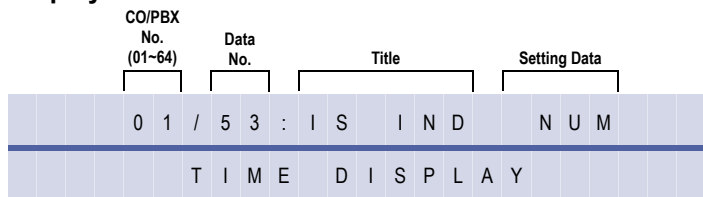







## Settings

LK 1	LK 2	LK 3	LK 4	LK 5	LK 6	LK 7	LK 8
NO	NUM	NAM		TRK			

The shaded area indicates the default setting.



## Programming Procedures

- Go off-line.
- Press LK3 +  +   to access the Memory Block.
- Press the corresponding CO/PBX line key to change the data option.  
**Note:** Use the following to enter data:
  -  to move the cursor left
  -  to move the cursor right
  -  ~  to enter numeric data or CO/PBX No.

– OR –

  -  to go to the next assigned CO/PBX Line No.

Settings Include:

  - NO Disables caller name display.
  - NUM Displays Caller ID presented from the network.
  - NAM Selected when system speed dial buffers are assigned a name; the name is displayed when it is assigned to a matched number and Caller ID number matches the speed dial number.
  - TRK Selected if you want the trunk name or number to display when data is assigned in Memory Block 3-00 (Trunk Name/Number Assignment).
- Press  to write the data and display the next Memory Block.
- Program the next Memory Block or press  to go back on-line, after all data is written.

## Related Programming

M.B. Number	Memory Block Name
	Refer to individual features in the Xen IPK Features and Specifications manual.

# N

1. LK3 is used for System Speed Dial Name Match.
2. LK3 option will check all System Speed Dial Buffer Names assigned to Speed Dial Buffer Numbers 00~79 however, if System is set to 1000 Speed Dial Mode, LK3 will only check 000~099 (the first 100 Buffer Numbers and Names) and the remainder (100~999) will not be checked.

Memory Block	Settings							
	Number	Number	Number	Number	Name	Name	Name	Name
3-53								
1-8-08 Page 4, LK3	<b>ON</b>	<b>ON</b>	<b>ON</b>	<b>ON</b>	<b>ON</b>	<b>ON</b>	<b>ON</b>	<b>ON</b>
1-8-08 Page 4, LK4	ON	ON	OFF	OFF	ON	ON	OFF	OFF
1-8-08 Page 5, LK7	ON	OFF	ON	OFF	OFF	ON	ON	OFF
MLT LCD Line 1	CID Number	CID Number	CID Number	CID Number	CID Number	CID Number	CID Name	CID Name
MLT LCD Line 2	Date/Time	Date/Time	Date/Time	Date/Time	Date/Time	CID Name	CID Number	Date/Time

- ☉ Calls received from a Mobile Phone on an analogue COI trunk will display “MOBILE” in place of CID Name when Memory Block 3-71 is set to CO.
- ☉ Calls received from a Pay Phone on an analogue COI trunk will display “PAYPHONE” in place of the CID Name.
- ☉ If Memory Block 8-71 is set to “SPD” and Memory Block 3-53 is set to “Name”, the received Caller ID will always be matched against system speed dials.

# ISDN Dial-Out Sending Selection

## General Description

Use this Memory Block to specify whether a an ISDN call is to be sent En Block or Overlap.

Applicable to IPK R2000 and above.

## Display

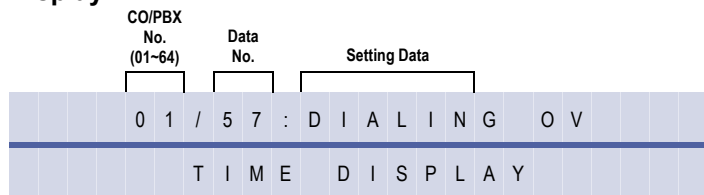

*System Mode*  
**3**

*Submode*  
—

*Data No.*  
**57**







*PC Programming*  
 + AU

## Settings

LK 1	LK 2	LK 3	LK 4
OV	EN		
LK 5	LK 6	LK 7	LK 8

The shaded area indicates the default setting.

## Programming Procedures

1	Go off-line.
2	Press LK3 +  +   to access the Memory Block.
3	Press the corresponding CO/PBX line key to change the data option. <b>Note:</b> Use the following to enter data:  to go to the next CO/PBX Line No.
4	Press  to write the data.
5	Press  to go back on-line.

## Related Programming

M.B. Number	Memory Block Name
7-1	Card Interface Slot Assignment
1-13-00	PRI Channel Assignment
1-13-04	PRT B Channel Outgoing Priority Selection
3-03	Trunk-to-Trunk Group Assignment
3-91	Trunk Type Selection
1-1-81	ISDN Dial Out Interval Timer

# Automated Attendant Function Selection

## General Description

Use this Memory Block to specify if the Automated Attendant is to operate in the Normal Mode, or the Automated Attendant Delay Announcement mode.

## Display

CO/PBX No. (01-64)	Data No.	Title	Setting Data
0 1 /	5 9 :	A . A .	N O R M A L
T I M E D I S P L A Y			

System Mode  
**3**

Submode  
—

Data No.  
**59**

PC Programming



## Settings

LK 1	LK 2	LK 3	LK 4
A.A. Normal (A.A./DISA)	A.A. Delay Announcement		
LK 5	LK 6	LK 7	LK 8

The shaded area indicates the default setting.

## Programming Procedures

1	Go off-line.
2	Press LK3 +  +   to access the Memory Block.
3	Press the corresponding CO/PBX line key to change the data option. <b>Example:</b> To change A.A. Normal (A.A./DISA) to A.A. Delay Announcement, press CO/PBX line key 2. to go to the next CO/PBX Line No.
4	Press  to write the selected data and advance to Next CO Number's Memory Block , 3-00 , Trunk Name/Number Assignment.
5	Press  to go back on-line.

## Related Programming

General Information	ISDN Caller Name Indication Selection
<b>1-4-18</b>	Automated Attendant Delay Announcement Assignment
<b>1-4-19</b>	Automated Attendant 1st to 2nd Delay Announcement Interval Time Selection
<b>1-4-20</b>	Automated Attendant Delay Announcement Disconnect Time Selection

# DIT Delay Answer Timer Selection

System Mode  
**3**

Submode  
**—**

Data No.  
**61**

PC Programming  
 + AU

## General Description

This Memory Block is used to specify the time an incoming CO/PBX Call will ring before changing to DIT.

With IPK R2000 and above, this memory block allows flexible entry.

*For R2000 only.*

## Display







CO/PBX No. (01-64)	Data No.	Title	CO/PBX No. (01-64)
1 1 /	6 1 :	D Y L A N S	O S
T I M E D I S P L A Y			

## Settings

LK 1	LK 2	LK 3	LK 4
0s	5s	10s	20s
LK 5	LK 6	LK 7	LK 8
30s	40s	50s	60s

The shaded area indicates the default setting.

## Programming Procedures







- 1 Go off-line.
- 2 Press LK3 +  +   to access the Memory Block.
- 3 Press the corresponding CO/PBX line key to change the data option.  
**Note:** Use the following to enter data:  
 = Next CO/PBX Line No.
- 4 Press  to write the data.
- 5 Press  to go back on-line.

*For R2000 and above.*

## Display

CO/PBX No. (01-64)	Data No.	Title	CO/PBX No. (01-64)
1 1 /	6 1 :	D L Y A N S	0 0 s
T I M E D I S P L A Y			

**Programming Procedures**

<b>1</b>	Go off-line.
<b>2</b>	Press LK3 +  +   to access the Memory Block.
<b>3</b>	<div style="display: flex; justify-content: space-between;"> <div style="width: 60%;"> <p>Use the dial pad to enter the time required.</p> <p><i>Note:</i>  to move cursor left.   to move cursor right.</p> <p>Setting Data (Allow): Class 1 to Class 4: 00 to 99 sec                      (00 = Unlimited)</p> </div> <div style="width: 35%; border-left: 1px solid black; padding-left: 10px;"> <p>Default values:                      Trunk 01~64 = 00 sec</p> </div> </div>
<b>4</b>	Press  to write the data.
<b>5</b>	Press  to go back on-line.

**Related Programming**

M.B. Number	Memory Block Name
<b>3-63</b>	DIT Tenant Assignment
<b>3-64</b>	DIT Holiday Mode Enable
<b>3-65</b>	DIT Night Mode Delay Answer Enable
<b>4-71</b>	Time Class Assignment for Telephone Mode (R2000 and above)

**N**

When the time is set to a value other than 0, call termination is treated as a normal incoming call and DIT termination is performed after the time elapses. When 0 is selected, DIT call termination is performed immediately.

# DIT Tenant Assignment

## General Description

This Memory Block is used to assign a CO/PBX Line to each tenant for incoming DIT calls.

## Display

CO/PBX No. (01-64)	Data No.	Title	Tenant No. (00-47)
0 1	/ 6 2	: D I T = T N T	0 0
T I M E D I S P L A Y			

System Mode  
**3**









Submode  
**—**

Data No.  
**62**

PC Programming

 + BCT

## Programming Procedures

<b>1</b>	Go off-line.	
<b>2</b>	Press LK3 +  +   to access the Memory Block.	
<b>3</b>	Press the corresponding CO/PBX line key to change the data option. <b>Note:</b> Use the following to enter data: <ul style="list-style-type: none"> <li> to move the cursor left</li> <li> to move the cursor right</li> <li> ~  to enter numeric data</li> </ul>	<b>Default Values</b> All CO/PBX Lines are set to tenant 00.
<b>4</b>	Press  to write the data.	
<b>5</b>	Press  to go back on-line.	

## Related Programming

M.B. Number	Memory Block Name
<b>4-09</b>	Telephone to Tenant Assignment

1-Line Number to be Displayed (3-53 = Number)

	MB , 3-70 = CO	MB , 3-70 = SPD
Name Supplied – SPD Match	CO Number	CO Number
	Clock	Clock
Name Supplied – No SPD Match	CO Number	CO Number
	Clock	Clock
No Name Supplied – SPD Match	CO Number	CO Number
	Clock	Clock
No Name Supplied – No SPD Match	CO Number	CO Number
	Clock	Clock



1-Line Number to be Displayed (3-53=Name, 1-8-08 P4/LK4=OFF, 1-8-08 P5/LK7=OFF)

	MB , 3-70 = CO	MB , 3-70 = SPD
Name Supplied – SPD Match	SPD Name	SPD Name
	Clock	Clock
Name Supplied – No SPD Match	SPD Name	SPD Name
	Clock	Clock
No Name Supplied – SPD Match	SPD Name	SPD Name
	Clock	Clock
No Name Supplied – No SPD Match	SPD Name	SPD Name
	Clock	Clock

2-Line Number and Name to be Displayed (3-53=Name, 1-8-08 p4/lk4=ON, 1-8-08 P5/LK7=ON)  
 (1st & 2nd lines are reversed if 1-8-08 P4/LK4-OFF)

	MB , 3-70 = CO	MB , 3-70 = SPD
Name Supplied – SPD Match	CO Number	CO Number
	CO Name	SPD Name
Name Supplied – No SPD Match	CO Number	CO Number
	CO Name	CO Name
No Name Supplied – SPD Match	CO Number	CO Number
	Clock	SPD Name
No Name Supplied – No SPD Match	CO Number	CO Number
	Clock	Clock

# DIT Holiday Mode Enable

## General Description

This Memory Block is used to enable Holiday Mode checking on tenant groups for incoming DIT calls.

## Display

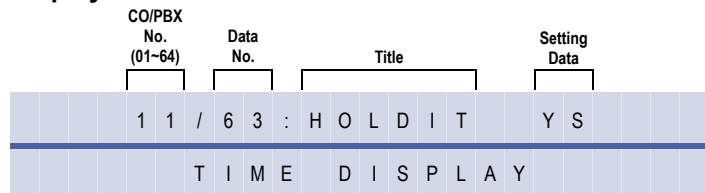









*System Mode*  
**3**  
*Submode*  
**—**  
*Data No.*  
**63**  
*PC Programming*  
 + BCT

## Settings

LK 1	LK 2	LK 3	LK 4
Yes	No	10s	20s
LK 5	LK 6	LK 7	LK 8
30s	40s	50s	60s

The shaded area indicates the default setting.

## Programming Procedures

- Go off-line.
- Press LK3 +  +   to access the Memory Block.
- Press the corresponding CO/PBX line key to change the data option.  
**Note:** Use the following to enter data:  
 to move the cursor left  
 to move the cursor right  
 to enter numeric data  
 to go to the next CO/PBX Line No.
- Press  to write the data.
- Press  to go back on-line.

## Related Programming

M.B. Number	Memory Block Name
4-09	Telephone to Tenant Assignment



- During Holiday Mode and Night Mode Ring Assignments apply, regardless of time or day or night.
- Holiday Mode can be set on a System Wide or Tenant Specific basis.
- DIT Holiday Mode only effects CO/PBX calls to extensions set with DIT facility.

# DIT Night Mode Delay Answer Enable

System Mode  
**3**

Submode  
—

Data No.  
**64**

PC Programming



## General Description

This Memory Block is used to specify whether or not the DIT Delay Answer Timer shall apply to CO/PBX calls received when the system is in Night Mode.

## Display

CO/PBX No. (01-64)	Data No.	Title	Setting Data
1 1 / 6 4 :		N T M O D	N 0
T I M E D I S P L A Y			

## Settings

LK 1	LK 2	LK 3	LK 4
No	Yes		
LK 5	LK 6	LK 7	LK 8

The shaded area indicates the default setting.

## Programming Procedures

1	Go off-line.
2	Press LK3 +  +   to access the Memory Block.
3	Press the corresponding CO/PBX line key to change the data option. <b>Note:</b> Use the following to enter data: to move the cursor left to move the cursor right to go to the next CO/PBX Line No.
4	Press  to write the data.
5	Press  to go back on-line.

## Related Programming

M.B. Number	Memory Block Name
3-62	DIT Delay Answer Timer Selection

# N

1. The DIT Delay Answer Time specified in MB , 3-62 shall apply for this purpose.
2. If set to YES, incoming CO/PBX calls during Night Mode will ring for the duration specified in MB , 3-62 before changing to DIT status.
3. If set to NO, incoming CO/PBX calls during Night Mode will immediately change to DIT status regardless of the setting in MB , 3-52.
4. This setting only applies to those CO/PBX lines assigned with the DIT facility in MB , 3-44 and MB , 3-45.

# Hold Tone Automated Attendant Selection

## General Description

Use this Memory Block to specify which message is to be played for a particular trunk.

## Display

CO/PBX No. (01-64)	Data No.	Title	Setting Data	Page No.
01	65	INCMMSG	NONE	1
TIME DISPLAY				

System Mode  
**3**

Submode  
—

Data No.  
**65**

PC Programming  
 + BCT

## Settings

### (Page 1)









LK 1	LK 2	LK 3	LK 4
NONE	MSG1	MSG2	MSG3
LK 5	LK 6	LK 7	LK 8
MSG4	MSG5	MSG6	MSG7

### (Page 2)

LK 1	LK 2	LK 3	LK 4
MSG8			
LK 5	LK 6	LK 7	LK 8

The shaded area indicates the default setting.

## Programming Procedures

- Go off-line.
- Press LK3 +  +   to access the Memory Block.
- Press the corresponding CO/PBX line key to change the data option.  
**Note:** The following to enter data:  
 to go to the next page  
 to go to the previous page  
 to go to the next CO/PBX Line No.
- Press  to write the data.
- Press  to go back on-line.

## Related Programming

M.B. Number	Memory Block Name
3-61	Automated Attendant Function Selection

# CO Line Ringing Pattern Selection for CO/PBX Line Mode

## General Description

Use this Memory Block to specify the ring pattern for incoming calls or CO lines.

## Display

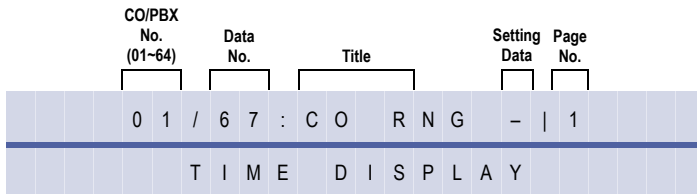

*System Mode*  
**3**  
*Submode*  
**—**  
*Data No.*  
**67**  
*PC Programming*  
 + AU

## Settings

### (Page 1)









LK 1	LK 2	LK 3	LK 4
—	A	B	C
LK 5	LK 6	LK 7	LK 8
D	E	F	G

### (Page 2)

LK 1	LK 2	LK 3	LK 4
H			
LK 5	LK 6	LK 7	LK 8

The shaded area indicates the default setting.

## Programming Procedures

1	Go off-line.	
2	Press LK3 +  +   to access the Memory Block.	
3	Press the corresponding CO/PBX line key to change the data option. <b>Note:</b> The following to enter data:  to go to the next page  to go to the previous page  to go to the next CO/PBX Line No.	<b>Default Values</b> — = NON
4	Press  to write the data.	
5	Press  to go back on-line.	

## Related Programming

M.B. Number	Memory Block Name
4-53	CO Ringing Pattern Selection for Telephone Mode
4-56	CO Line Ringing Pattern by Telephone or CO Selection

Ring Patterns are shown in the table below:

**s= seconds**

Pattern	0s	1s	2s	3s	4s	5s	6s
A							
B							
C							
D							
E							
F							
G							
H							
NIL	No Ring						

# N

1. This Memory Block is controlled by MB , 4-57. Calls can be CO ringing or telephone ringing.
2. This Memory Block is applicable for main software Release 4.0 and above.

# CIC Number Assignment

## General Description

Use this Memory Block to assign the Circuit Identification Code for each voice channel used for K-CCIS.

## Display

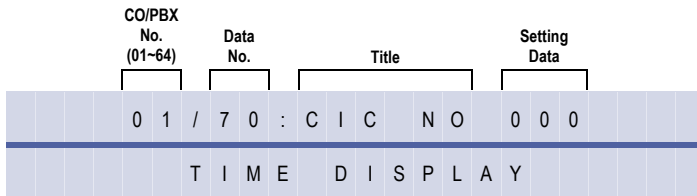

*System Mode*  
**3**  
*Submode*  
**—**  
*Data No.*  
**70**  
*PC Programming*  
 + **AW**

## Programming Procedures

- 1 Go off-line.
- 2 Press LK3 + + to access the Memory Block.
 

**Default Values**  
 000 (Not Specified)  
 CIC Number Range: 001~127

**Note:** The following to enter data:

  - to go to the next page
  - to go to the previous page
  - ~ to enter numeric data

**– OR –**

  - to go to the next CO/PBX No.
- 3 Press to write the selected data and display next Memory Block or Memory BLock 3-00 CO/PBX 02. After the last CO/PBX is programmed, CO/PBX 01 is displayed again.

## Related Programming

M.B. Number	Memory Block Name
1-1-05	Start Time Selection
1-15-00	K-CCIS Main/Remote Office selection
1-15-02	Common Signal Channel Assignment
1-15-03	Originating Point Code Assignment
1-15-04	Destination Point Code Assignment
1-15-05	Destination Point Code Transfer Assignment
1-15-06	Originating Office Code Number Assignment
1-15-07	K-CCIS Message Response Timeout Assignment
1-15-08	Link Reconnect Allow/Deny Selection
1-15-09	K-CCIS Maximum Call Forwarding Hop Assignment
1-15-10	Calling Name Display Allow/Deny Selection



CIC Numbers must be assigned consecutively for K-CCIS to operate correctly.

# Caller Name Display Assignment

## General Description

Use this Memory Block to specify whether the network provided name or the speed dial match name is to be displayed.

## Display

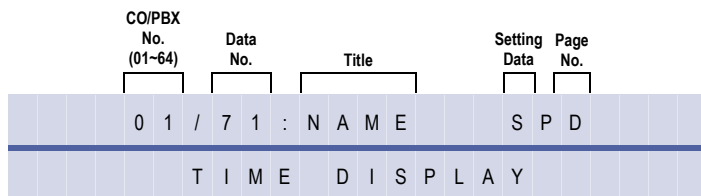

*System Mode*  
**3**

*Submode*  
—

*Data No.*  
**71**

*PC Programming*

+ **BCT**

## Settings

(Page 1)

LK 1	LK 2	LK 3	LK 4
CO	SPD		
LK 5	LK 6	LK 7	LK 8

The shaded area indicates the default setting.

## Programming Procedures

- 1 Go off-line.
- 2 Press LK3 + + to access the Memory Block.
- 3 Press the corresponding CO/PBX line key to change the data option.  
**Note:** The following to enter data:  
 to go to the next page  
 to go to the previous page  
 ~ to enter numeric data  
 to go to the next CO/PBX Line No.
- 4 Press to write the data.
- 5 Press to go back on-line.

## Related Programming

M.B. Number	Memory Block Name
<b>1-1-78</b>	Caller ID Display Assignment for System Mode
<b>1-8-08</b>	Class of Service (Station) Feature Selection 2
<b>3-45</b>	Caller ID Display Assignment for CO/PBX Line
<b>3-59</b>	Caller Name Indication Selection
<b>4-50</b>	Caller ID Display for CAR Key



The following tables show the resultant displays when MB , 3-72 and associated memory blocks are programmed in various ways.



# ISDN BRT Connection Configuration

System Mode  
**3**

Submode  
—

Data No.  
**72**

PC Programming



## General Description

Use this Memory Block to specify the type of Basic Rate ISDN Connection configuration required.

## Display

CO/PBX No. (01-64)	Data No.	Title	Setting Data
01	72	CONN	P - M P
T I M E D I S P L A Y			

## Settings

LK 1	LK 2	LK 3	LK 4
P-MP	P-P		
LK 5	LK 6	LK 7	LK 8

The shaded area indicates the default setting.

## Programming Procedures

1	Go off-line.
2	Press LK3 +  +   to access the Memory Block.
3	Press the corresponding CO/PBX line key to change the data option. <b>Note:</b> Use the following to enter data: to move the cursor left to move the cursor right to go to the next CO/PBX Line No.
4	Press  to write the data.
5	Press  to go back on-line.

## Related Programming

M.B. Number	Memory Block Name
7-1	Card Interface Slot Assignment



P-MP=Point to Multipoint  
P-P=Point to Point

# Polarity Reverse Selection

## General Description

In some cases a Central Office may provide a line reversed to provide a disconnect signal.

## Display

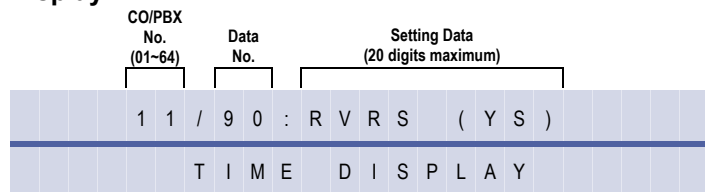

*System Mode*  
**3**

*Submode*  
—

*Data No.*  
**90**









*PC Programming*  
 + AN

## Settings

LK 1	LK 2	LK 3	LK 4
No	Yes		
LK 5	LK 6	LK 7	LK 8

The shaded area indicates the default setting.

## Programming Procedures

1	Go off-line.
2	Press LK3 +  +   to access the Memory Block.
3	Press the corresponding CO/PBX line key to change the data option. <b>Note:</b> Use the following to enter data: <ul style="list-style-type: none"> <li> to move the cursor left</li> <li> to move the cursor right</li> <li> to go to the next CO/PBX Line No.</li> </ul>
4	Press  to write the data.
5	Press  to go back on-line.

## Related Programming

No related programming is necessary for this Memory Block.



BRI and PRI lines are to be set to YES at all times.

# Trunk Type Selection

## General Description

This Memory Block specifies each external line as CO line, PBX/CTX line, Tie/DID line, or CTX Assume - 9.

## Display

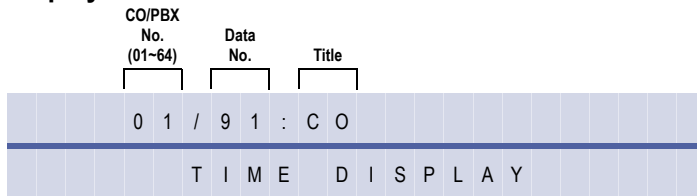









*System Mode*  
**3**  
*Submode*  
**—**  
*Data No.*  
**91**  
*PC Programming*  
 + BCT

## Settings

LK 1	LK 2	LK 3	LK 4
CO	PBX/CTX	Tie	DID
LK 5	LK 6	LK 7	LK 8
CTX Assume - 9			

The shaded area indicates the default setting.

## Programming Procedures

- 1 Go off-line.
- 2 Press LK3 +  +   to access the Memory Block.
- 3 Press the corresponding CO/PBX line key to change the data option.  
**Note:** Use the following to enter data:  
 to move the cursor left  
 to move the cursor right  
 to go to the next CO/PBX Line No.
- 4 Press  to write the data.
- 5 Press  to go back on-line.

## Related Programming

No related programming is necessary for this Memory Block.

## N

1. Integrated Services Digital Network (ISDN) lines cannot be assigned as PBX/CTX or CTX Assume-9. A CTX Transfer will not work on ISDN lines.
2. This Memory Block specifies if ISDN lines are to be DID or normal CO ring.

# Trunk (Installed, DP/DTMF) Selection

*System Mode*  
**3**  
*Submode*  
**—**  
*Data No.*  
**92**  
*PC Programming*  
 + BCT

## General Description

This Memory Block specifies each external line as DP (10 pps or 20 pps) or DTMF line or not connected (NIL).

## Display









CO/PBX No. (01~64)	Data No.	Setting Data
0 1 /	9 2 :	M F
T I M E D I S P L A Y		

## Settings

LK 1	LK 2	LK 3	LK 4
NIL	DP 10 pps	DP 20 pps	MF
LK 5	LK 6	LK 7	LK 8

The shaded area indicates the default setting.

## Programming Procedures

1	Go off-line.
2	Press LK3 +  +   to access the Memory Block.
3	Press the corresponding CO/PBX line key to change the data option. <b>Note:</b> Use the following to enter data:  to move the cursor left  to move the cursor right  to go to the next CO/PBX Line No.
4	Press  to write the data.
5	Press  to go back on-line.

## Related Programming

M.B. Number	Memory Block Name
3-14	Tie/DID Line Type Assignment
4-12	Line Key Selection for Telephone Mode



1. When Port 01 displays CO XX layer message, use NIL setting for unused BRI interfacing to clear display.
2. Only Tie lines and Direct Inward Dialling (DID) trunks can use dial pulse on the Xen IPK System. All other trunks must be set to multi frequency (MF).

# CO/PBX Ring Assignment (Day Mode)

## General Description

Use this Memory Block to assign incoming CO/PBX calls to ring on Multiline Terminals in the Day Mode.

## Display

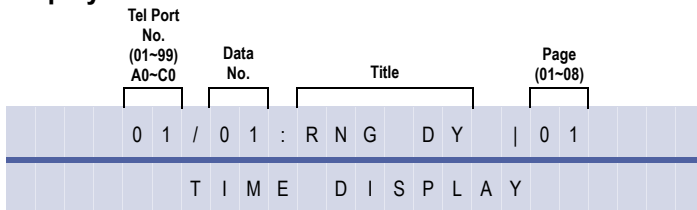

## Settings

### Page 1 (Ports 01~08)

LK 1	LK 2	LK 3	LK 4
01	02	03	04
LK 5	LK 6	LK 7	LK 8
05	06	07	08

### Page 2 (Ports 09~16)

LK 1	LK 2	LK 3	LK 4
09	10	11	12
LK 5	LK 6	LK 7	LK 8
13	14	15	16

### Page 3 (Ports 17~24)

LK 1	LK 2	LK 3	LK 4
17	18	19	20
LK 5	LK 6	LK 7	LK 8
21	22	23	24

### Page 4 (Ports 25~32)

LK 1	LK 2	LK 3	LK 4
25	26	27	28
LK 5	LK 6	LK 7	LK 8
29	30	31	32

### Page 5 (Ports 33~40)

LK 1	LK 2	LK 3	LK 4
33	34	35	36
LK 5	LK 6	LK 7	LK 8
37	38	39	40

### Page 6 (Ports 41~48)

LK 1	LK 2	LK 3	LK 4
41	42	43	44
LK 5	LK 6	LK 7	LK 8
45	46	47	48

The shaded area indicates the default setting.

System Mode  
**4**  
 Submode  
 —  
 Data No.  
**01**  
 PC Programming  
 + BTT

**Settings**









**Page 7 (Ports 49~56)**

LK 1	LK 2	LK 3	LK 4
49	50	51	52
LK 5	LK 6	LK 7	LK 8
53	54	55	56

**Page 8 (Ports 57~64)**

LK 1	LK 2	LK 3	LK 4
57	58	59	60
LK 5	LK 6	LK 7	LK 8
61	62	63	64

**Programming Procedures**

<b>1</b>	Go off-line.									
<b>2</b>	Press LK4 +   to access the Memory Block.									
<b>3</b>	<p>Press the CO/PBX Line key corresponding to each CO/PBX number. The LED indication changes to indicate data each time a CO/PBX line key is pressed.</p> <table border="1" style="margin-left: 20px;"> <thead> <tr> <th>CO/PBX Line Key LED</th> <th>Off</th> <th>Green</th> <th>Red</th> </tr> </thead> <tbody> <tr> <td>Data</td> <td>No ring</td> <td>Immediate Ring</td> <td>Delayed Ring</td> </tr> </tbody> </table> <p><b>Note:</b> Use the following to enter data:   to move the cursor left   to move the cursor right   to move to the next Tel No.   to move to the next page   to move to the previous page</p>	CO/PBX Line Key LED	Off	Green	Red	Data	No ring	Immediate Ring	Delayed Ring	<p><b>Default Values</b>                  Tel Port numbers 01 and 02 ring on CO/PBX lines 01 ~ 08.                  Tel Port numbers 03 ~ 120 do not ring on any incoming CO/PBX calls.</p>
CO/PBX Line Key LED	Off	Green	Red							
Data	No ring	Immediate Ring	Delayed Ring							
<b>4</b>	After entering all data for all pages, press  to write the data.									
<b>5</b>	Press  to go back on-line.									

**Related Programming**

No related programming is necessary for this Memory Block.



Telephone ports A0~C0 are ports 100~120.

# CO/PBX Ring Assignment (Night Mode)

## General Description

Use this Memory Block to assign incoming CO/PBX calls to ring in the Night Mode.

## Display

Tel Port No. (01-99) A0-C0	Data No.	Title	Page
0 1 / 0 1	:	R N G N T	0 1
T I M E D I S P L A Y			

System Mode  
**4**

Submode  
—

Data No.  
**02**

PC Programming  
 + BTT

## Settings

### Page 1 (Ports 01~08)

LK 1	LK 2	LK 3	LK 4
01	03	03	04
LK 5	LK 6	LK 7	LK 8
05	06	07	08

### Page 2 (Ports 09~16)

LK 1	LK 2	LK 3	LK 4
09	10	11	12
LK 5	LK 6	LK 7	LK 8
13	14	15	16

### Page 3 (Ports 17~24)

LK 1	LK 2	LK 3	LK 4
17	18	19	20
LK 5	LK 6	LK 7	LK 8
21	22	23	24

### Page 4 (Ports 25~32)

LK 1	LK 2	LK 3	LK 4
25	26	27	28
LK 5	LK 6	LK 7	LK 8
29	30	31	LK 1

### Page 5 (Ports 33~40)

LK 1	LK 2	LK 3	LK 4
33	34	35	36
LK 5	LK 6	LK 7	LK 8
37	38	39	40

The shaded area indicates the default setting.

**Settings**

**Page 6 (Ports 41~48)**

LK 1	LK 2	LK 3	LK 4
41	42	43	44
LK 5	LK 6	LK 7	LK 8
45	46	47	48









**Page 7 (Ports 49~56)**

LK 1	LK 2	LK 3	LK 4
49	50	51	52
LK 5	LK 6	LK 7	LK 8
53	54	55	56

**Page 8 (Ports 57~64)**

LK 1	LK 2	LK 3	LK 4
57	58	59	60
LK 5	LK 6	LK 7	LK 8
61	62	63	64

**Programming Procedures**

<b>1</b>	Go off-line.									
<b>2</b>	Press LK4 +   to access the Memory Block.									
<b>3</b>	<p>Press the CO/PBX Line key corresponding to each CO/PBX number. The LED indication changes to indicate data each time a CO/PBX line key is pressed.</p> <table border="1" style="margin-left: 20px;"> <thead> <tr> <th>CO/PBX Line Key LED</th> <th>Off</th> <th>Green</th> <th>Red</th> </tr> </thead> <tbody> <tr> <td>Data</td> <td>No ring</td> <td>Immediate Ring</td> <td>Delayed Ring</td> </tr> </tbody> </table> <p><b>Note:</b> Use the following to enter data:   to move the cursor left   to move the cursor right   to move to the next Tel No.   to move to the next page   to move to the previous page</p>	CO/PBX Line Key LED	Off	Green	Red	Data	No ring	Immediate Ring	Delayed Ring	<p><b>Default Values</b>                  Tel Port numbers 01 and 02 ring on CO/PBX lines 01 ~ 08.                  Tel Port numbers 03 ~ 96 do not ring on any incoming CO/PBX calls.</p> <p>There is no default setting.</p>
CO/PBX Line Key LED	Off	Green	Red							
Data	No ring	Immediate Ring	Delayed Ring							
<b>4</b>	After entering all data for all pages, Press  to write the data.									
<b>5</b>	Press  to go back on-line.									

**Related Programming**

No related programming is necessary for this Memory Block.



Telephone ports A0~C0 are ports 100~120.



# Doorphone Chime Assignment (Day Mode)

## General Description

Use this Memory Block to assign up to four doorphones to ring at each station in the day mode.

## Display

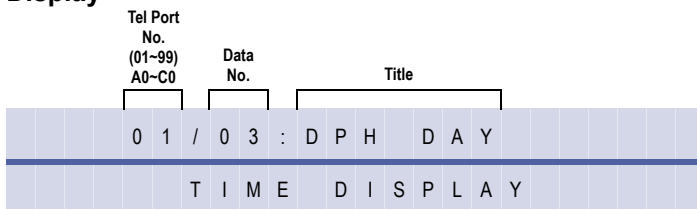

System Mode  
**4**

Submode  
—

Data No.  
**03**

PC Programming



## Settings

### Page 1 (Ports 01~08)

LK 1	LK 2	LK 3	LK 4
DP1	DP2	DP3	DP4
LK 5	LK 6	LK 7	LK 8

There is no default setting.

## Programming Procedures

1	Go off-line.	
2	Press LK4 +   to access the Memory Block.	
3	Use LK1~LK4 to assign ringing for doorphone 1~4.	<b>Default Values</b> Port 01 and 02 ring for all doorphones.
4	After entering all data, press  to write the data.	
5	Press  to go back on-line.	

## Related Programming

M.B. Number	Memory Block Name
1-7-00	Doorphone Assignment
1-7-01	Doorphone Display Time Selection
1-7-04	Doorphone Ringing Pattern Selection
1-7-05	Doorphone Ringing Frequency Selection



Telephone ports A0~C0 are ports 100~120.

# Doorphone Chime Assignment (Night Mode)

System Mode  
**4**

Submode  
**—**

Data No.  
**04**

PC Programming  
 + BTP

## General Description

Use this Memory Block to assign up to four doorphones to ring at each station in the Night Mode.

## Display

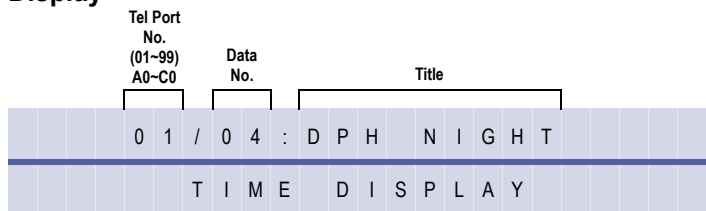





## Settings

### Page 1 (Ports 01~08)

LK 1	LK 2	LK 3	LK 4
DP1	DP2	DP3	DP4
LK 5	LK 6	LK 7	LK 8

There is no default setting.

## Programming Procedures

1	Go off-line.	
2	Press LK4 +   to access the Memory Block.	
3	Use LK1~LK4 to assign doorphone ringing for each station.	<b>Default Values</b> Ports 01 and 02 ring for all doorphones.
4	After entering all data, press  to write the data.	
5	Press  to go back on-line.	

## Related Programming

M.B. Number	Memory Block Name
1-7-00	Doorphone Assignment
1-7-01	Doorphone Display Time Selection
1-7-04	Doorphone Ringing Pattern Selection
1-7-05	Doorphone Ringing Frequency Selection



Telephone ports A0~C0 are ports 100~120.

# Automatic Outgoing CO/PBX Line Selection

## General Description

The memory block is used to determine which lines are automatically seized when an access code or Redial is pressed, and when a station goes Off-Hook (when Automatic Line Selection is set on Station).

## Display

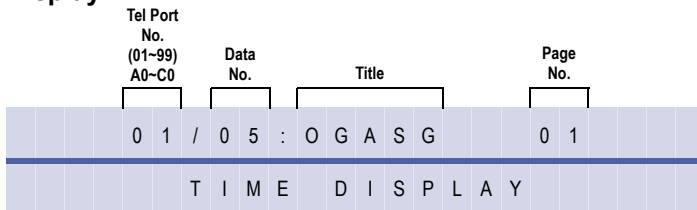

## Settings

### Page 1 (Ports 01~08)

LK 1	LK 2	LK 3	LK 4
01	02	03	04
LK 5	LK 6	LK 7	LK 8
05	06	07	08

### Page 2 (Ports 09~16)

LK 1	LK 2	LK 3	LK 4
09	10	11	12
LK 5	LK 6	LK 7	LK 8
13	14	15	16

### Page 3 (Ports 17~24)

LK 1	LK 2	LK 3	LK 4
17	18	19	20
LK 5	LK 6	LK 7	LK 8
21	22	23	24

The shaded area indicates the default setting.

### Page 4 (Ports 25~32)

LK 1	LK 2	LK 3	LK 4
25	26	27	28
LK 5	LK 6	LK 7	LK 8
29	30	31	32

### Page 5 (Ports 33~40)

LK 1	LK 2	LK 3	LK 4
33	34	35	36
LK 5	LK 6	LK 7	LK 8
37	38	39	40

System Mode  
**4**

Submode  
—

Data No.  
**05**

PC Programming  
 + BTT

**Settings**

**Page 6 (Ports 41~48)**

LK 1	LK 2	LK 3	LK 4
41	42	43	44
LK 5	LK 6	LK 7	LK 8
45	46	47	48

**Page 7 (Ports 49~56)**









LK 1	LK 2	LK 3	LK 4
49	50	51	52
LK 5	LK 6	LK 7	LK 8
53	54	55	56

The shaded area indicates the default setting.

**Page 8 (Ports 57~64)**

LK 1	LK 2	LK 3	LK 4
57	58	59	60
LK 5	LK 6	LK 7	LK 8
61	62	63	64

**Programming Procedures**

<b>1</b>	Go off-line.							
<b>2</b>	Press LK4 +   to access the Memory Block.							
<b>3</b>	<p>Press the CO/PBX Line key corresponding to each CO/PBX number. The LED indication changes to indicate data each time a CO/PBX line key is pressed.</p> <table border="1" style="margin-left: 20px;"> <tr> <td style="text-align: center;"><b>CO/PBX Line Key LED</b></td> <td style="text-align: center;"><b>Off</b></td> <td style="text-align: center;"><b>Green</b></td> </tr> <tr> <td style="text-align: center;"><b>Data</b></td> <td style="text-align: center;"><b>NO Selection</b></td> <td style="text-align: center;"><b>YES Selection</b></td> </tr> </table> <p><b>Note:</b> Use the following to enter data:   to move the cursor left   to move the cursor right   to move to the next Tel No.   to move to the next page   to move to the previous page</p>	<b>CO/PBX Line Key LED</b>	<b>Off</b>	<b>Green</b>	<b>Data</b>	<b>NO Selection</b>	<b>YES Selection</b>	<p><b>Default Values</b> Tel Port (01-CO) = All trunks (01~64) set to "YES"</p>
<b>CO/PBX Line Key LED</b>	<b>Off</b>	<b>Green</b>						
<b>Data</b>	<b>NO Selection</b>	<b>YES Selection</b>						
<b>4</b>	After entering all data for all pages, press  to write the data.							
<b>5</b>	Press  to go back on-line.							

**Related Programming**

M.B. Number	Memory Block Name
1-1-46	Access Code (1-Digit) Assignment
1-1-47	Access Code (2-Digit) Assignment
1-1-48	Access Code (3-Digit) Assignment

**N**

1. Telephone ports A0~C0 are ports 100~120.
2. Selection is made on a port by port, line by line basis.

# Code Restriction Class Assignment (Day Mode)

System Mode  
**4**  
 Submode  
 —  
 Data No.  
**07**  
 PC Programming  
 + AC









## General Description

Use this Memory Block to specify, per station, Code Restriction Class in Day Mode.

## Display

Tel Port No. (01~99) A0~C0	Data No.	Title	Setting Data (00~15)
01	/ 07	: C L S D A Y =	00
T I M E D I S P L A Y			

## Programming Procedures

1	Go off-line.	
2	Press LK4 +   to access the Memory Block.	
3	Use dial pad to enter data for Restriction Classes 00 ~15. <b>Note:</b> Use the following to enter data:  to move the cursor left  to move the cursor right  ~  to enter numeric data  to move to the next Tel No	<b>Default Values</b> All Stations Class 00
4	After entering all data, press  to write the data.	
5	Press  to go back on-line.	

## Related Programming

M.B. Number	Memory Block Name
	Refer to <i>Section 6, Code Restriction</i> in this chapter.



Telephone ports A0~C0 are ports 100~120.

# Code Restriction Class Assignment (Night Mode)

System Mode  
**4**

Submode  
—

Data No.  
**08**

PC Programming  
 + AC









## General Description

Use this memory block to specify, per station, Code Restriction Class in Night Mode.

## Display

Tel Port No. (01~99) A0~C0	Data No.	Title	Setting Data (00~15)
01	/ 08	: C L S N T	= 00
T I M E D I S P L A Y			

## Programming Procedures

<b>1</b>	Go off-line.	
<b>2</b>	Press LK4 +   to access the Memory Block.	
<b>3</b>	Use dial pad to enter data for Restriction Classes 00 ~15. <b>Note:</b> Use the following to enter data: <ul style="list-style-type: none"> <li> to move the cursor left</li> <li> to move the cursor right</li> <li> ~  to enter numeric data</li> <li> to move to the next Tel Port No.</li> </ul>	<b>Default Values</b> All Stations Class 00
<b>4</b>	After entering all data, press  to write the data.	
<b>5</b>	Press  to go back on-line.	

## Related Programming

M.B. Number	Memory Block Name
	Refer to <i>Section 6, Code Restriction</i> in this chapter.

# N

Telephone ports A0~C0 are ports 100~120.

# Telephone to Tenant Assignment

System Mode	4
Submode	—
Data No.	09
PC Programming	 + BTT









## General Description

Use this memory block to specify, per station, Tenant Assignment.

## Display

Tel Port No. (01~99) A0~C0	Data No.	Title	Setting Data (00~47)
01	/ 09	TENANT	= 00
TIME DISPLAY			

## Programming Procedures

1	Go off-line.	
2	Press LK4 +   to access the Memory Block.	
3	Use dial pad to enter data for Tenant Numbers 00 ~47. <b>Note:</b> Use the following to enter data:  to move the cursor left  to move the cursor right  ~  to enter numeric data  to move to the next Tel No.	<b>Default Values</b> All Telephones Tenant 00
4	After entering all data, Press  to write the data.	
5	Press  to go back on-line.	

## Related Programming

M.B. Number	Memory Block Name
2-01	Trunk to Tenant Assignment
2-05	Line Key Selection
2-06	Line Key Selection for Tenant Mode
2-07	System Speed Dial Display Assignment
2-08	ECR Relay to Tenant Assignment



1. Stations can be assigned to one of 48 Tenant Number (00 ~ 47).
2. The Call Pickup Group is determined by Tenant assignment.
3. Telephone ports A0~C0 are ports 100~120.



# Station Number Assignment

## General Description

Use this memory block to assign a station number to each telephone.

## Display

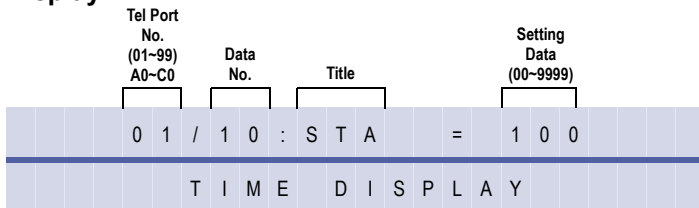









System Mode  
**4**

Submode  
—

Data No.  
**10**

PC Programming  
 + BS

## Programming Procedures

<b>1</b>	Go off-line.	
<b>2</b>	Press LK4 +   to access the Memory Block.	
<b>3</b>	Use dial pad to enter Setting Data for 2- (00~99) , 3- (000~999), or 4-digit (0000~9999) station number. <b>Note:</b> Use the following to enter data: <ul style="list-style-type: none"> <li> to move the cursor left</li> <li> to move the cursor right</li> <li> ~  to enter numeric data</li> <li> to move to the next Tel No</li> </ul>	<b>Default Values</b> Valid Station Numbers are 100 ~399.
<b>4</b>	After entering all data, press  to write the data.	
<b>5</b>	Press  to go back on-line.	

## Related Programming

M.B. Number	Memory Block Name
<b>1-1-46</b>	Access Code (1-Digit) Assignment
<b>1-1-47</b>	Access Code (2-Digit) Assignment
<b>1-2-03</b>	2-, 3-, or 4-Digit Station Number Selection

# N

1. Station Number Assignment is per station. A station number cannot be assigned to more than one telephone. A telephone cannot have more than one station number.
2. When changing Station Numbers to a different numbering plan perform the following steps in order.
  - a. Select Station Numbers using Memory Block , 1-2-03 , 2-, 3-, or 4-Digit Station Number Selection.
  - b. Program applicable Access Code in Memory Block , 1-1-46 , Access Code (1-Digit) Assignment or , 1-1-47 , Access Code (2-Digit) Assignment.
  - c. Program all Station Numbers using this Memory Block.
3. Telephone ports A0~C0 are ports 100~120.

# Ringing Line Preference Selection

## General Description

Use this memory block to specify whether or not each station user can answer incoming ringing CO/PBX calls by going off-hook.

## Display

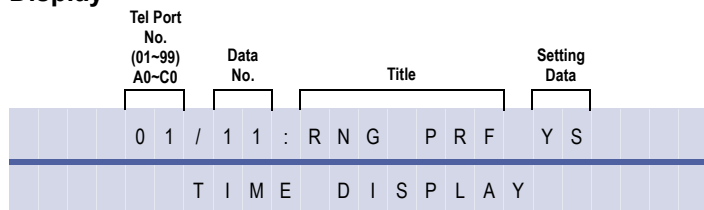

System Mode  
**4**

Submode  
—

Data No.  
**11**

PC Programming  
 + BTM

## Settings

LK 1	LK 2	LK 3	LK 4
No	Yes		
LK 5	LK 6	LK 7	LK 8

The shaded area indicates the default setting.

## Programming Procedures

- 1 Go off-line.
- 2 Press LK4 + to access the Memory Block.
- 3 Press the corresponding CO/PBX line key to change the data option.  
**Note:** Use the following to enter data:  
 to move to the next Tel Port No.
- 4 After entering all data, press to write the data.
- 5 Press to go back on-line.

## Related Programming

M.B. Number	Memory Block Name
4-01	CO/PBX Ring Assignment (Day Mode)
4-02	CO/PBX Ring Assignment (Night Mode)



1. Programming for this Memory Block applies to Ring Assigned telephones only.
2. An intercom call cannot be originated after a ring assigned CO/PBX line terminates on the telephone.
3. Telephone ports A0~C0 are ports 100~120.

# Line Key Selection for Telephone Mode

## General Description

Use this Memory Block to assign functions to each CO/PBX line key on each telephone in a tenant specified as Telephone Mode in Memory Block , 2-05 , Line Key Selection.

## Display

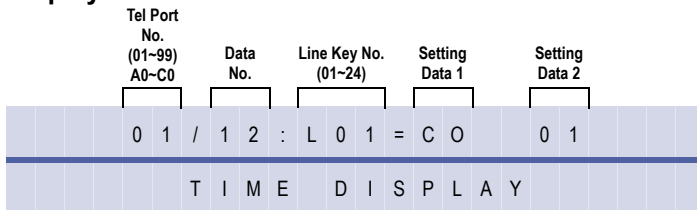

## Settings

LK 1	LK 2	LK 3	LK 4
Not Specified	CO/PBX Line	CFW-B/NA	CFW-ALL
LK 5	LK 6	LK 7	LK 8
Call Appearance	Feature Access	Trunk Group	Route Advance

LK 9	LK 10	LK 11	LK 12
SIE/CAR	Microphone Key	Headset	Scroll Key for Caller ID
LK 13	LK 14	LK 15	LK 16
DND On/Off	LOG On/Off	BGM On/Off	ICM

The shaded area indicates the default setting.

## Programming Procedures

1	Go off-line.	
2	Press LK4 +   to access the Memory Block.	
3	Press corresponding CO/PBX line key to change setting data 1. <b>Note:</b> Use the following to enter data: <ul style="list-style-type: none"> <li> to move the cursor left</li> <li> to move the cursor right</li> <li> ~  to enter setting data 2</li> <li> to move to the next Tel Port No</li> </ul> For example, to assign Trunk Group 5 to CO/PBX line key 1, press LK7 to display TKGP, and enter 05 (for RT 05) using the dial pad.	<b>Default Values</b> For Tel 01~CO: LK01~08 Assigned to CO/PBX lines 01~08.
4	Press  to write the data and display the next line key.	
5	Repeat example and step 4 until all line key assignments are complete, and press  to enter last data.	
6	Press  to go back on-line.	

System Mode  
**4**

Submode  
—

Data No.  
**12**

PC Programming



**Related Programming**

M.B. Number	Memory Block Name
2-06	Line Key Selection for Tenant Mode

**Function Table**

Line Key	Functions [For each telephone in tenant specified as Telephone Mode in Memory Block 2-05 (Line Key Selection)]	Setting Data 1 LCD Indication	Setting Data 2
1	Not Specified	NON	N/A
2	CO/PBX line	CO	01~64
3	Call Forward - Busy/No Answer	FW BNA	N/A
4	Call Forward - All Call	FW ALL	N/A
5	Call Appearance Block (00~47). Refer to Note 6	C	Call Appearance Key 01~24
6	Feature Access	FA	01~16
7	Trunk Group	TKGP	01~32
8	Route Advance	ADV	01~32
9	Secondary Incoming Extension	SIE	Telephone Port No. 01~99 A0~C0
10	Microphone	MIC	N/A
11	Headset	H SET	N/A
12	Scroll Key for Caller ID	SCROLL	N/A
13	Do Not Disturb - Break Mode On/Off	DND	N/A
14	Log On/Off	LOG	N/A
15	Background Music On/Off	BGM	N/A
16	Intercom Key	ICM	N/A

**N**

1. If an Xen system is installed as a Key Function (KF) system, all COs must be assigned to the line keys. Trunk Groups, Route Advance and Least Cost Routing (LCR) cannot be assigned.
2. At system default, line keys 09~24 are not assigned.
3. Telephone ports A0~C0 are ports 100~120.

# CO/PBX Busy Forward Station Assignment

## General Description

Use this Memory Block to specify up to two telephones to ring when a CO/PBX call terminates at a busy station.

## Display

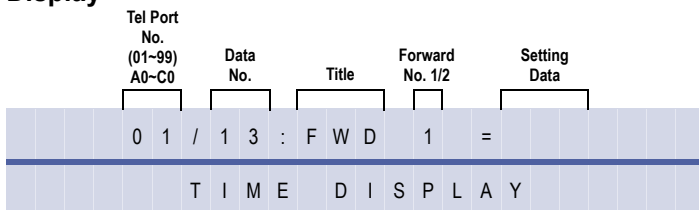

System Mode  
**4**  
 Submode  
 —  
 Data No.  
**13**  
 PC Programming  
 + BTT

## Programming Procedures

1	Go off-line.	
2	Press LK4 +   to access the Memory Block.	
3	Use dial pad to change data. <b>Note:</b> Use the following to enter data: to move the cursor left to move the cursor right ~  to enter numeric data to move to the next Tel Port No <b>Setting Data: Port No. 01 ~120</b>	<b>Default Values</b> Not specified
4	Press  to write the data for the first transfer to station.	
5	Enter second transfer to station.	
6	Press  to write the data.	
7	Press  to go back on-line.	

## Related Programming

No related programming is necessary for this Memory Block.

# N

1. If the Multiline Terminal where the forward is initially set (Forward 1) is busy, the call is forwarded to a second specified station (Forward 2).
2. If all three stations are busy, the first station rings.
3. Telephone ports A0~C0 are ports 100~120.

# Intercom Master Hunt Number Selection

*System Mode*  
**4**  
*Submode*  
**—**  
*Data No.*  
**14**  
*PC Programming*  
 + BTT

## General Description

Use this memory block to assign a master intercom number to each telephone.

## Display

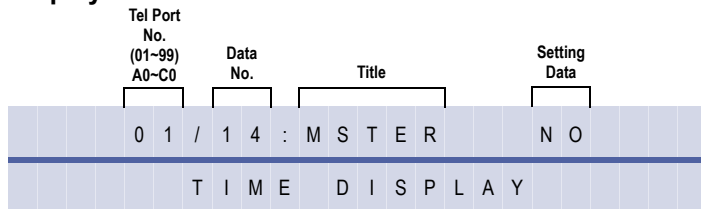





## Settings

LK 1	LK 2	LK 3	LK 4
No	Yes		
LK 5	LK 6	LK 7	LK 8

The shaded area indicates the default setting.

## Programming Procedures

- 1 Go off-line.
- 2 Press LK4 +   to access the Memory Block.
- 3 Press the corresponding CO/PBX line key to change data option  
**Note:** Use the following to change option:  
 to move to the next Tel Port No.
- 4 Press  to write the data.
- 5 Press  to go back on-line.

## Related Programming

M.B. Number	Memory Block Name
<b>4-15</b>	Intercom Master Hunt Number Forward Assignment

# N

1. If Yes is assigned, an incoming internal call from another station, Automated Attendant transferred call, or DIT/ANA/ DID/Tie line designated call is forwarded to a station specified in Memory Block , 4-15 , Intercom Master Hunt Number Forward Assignment if line is busy.
2. Telephone ports A0~C0 are ports 100~120.

# Intercom Master Hunt Number Forward Assignment

## General Description

Use this Memory Block to specify a telephone to ring when a Master Hunt Number specified in Memory Block , 4-14 , Intercom Master Hunt Number Selection is busy.

## Display

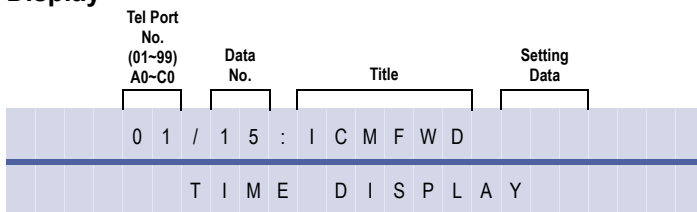

System Mode  
**4**

Submode  
—

Data No.  
**15**

PC Programming  
 + BTT

## Programming Procedures

1	Go off-line.	
2	Press LK4 +   to access the Memory Block.	
3	Use dial pad to enter data. To set Tel. Port No. 01 to forward station number 300, enter 300. <b>Note:</b> Use the following to enter data: <ul style="list-style-type: none"> <li> to move the cursor left</li> <li> to move the cursor right</li> <li> ~  to enter numeric data</li> <li> clear data when cursor is at setting data</li> <li> to move to the next Tel Port No.</li> </ul> <b>Setting Data:</b> Forward Station Number is one of the following: <ul style="list-style-type: none"> <li>• 2 digit (00 ~ 99)</li> <li>• 3 digit (000 ~ 999)</li> <li>• 4 digit (0000 ~ 9999)</li> </ul>	<b>Default Values</b> All Telephones Not Specified
4	Press  to write the data.	
5	Press  to go back on-line.	

## Related Programming

M.B. Number	Memory Block Name
4-14	Intercom Master Hunt Number Selection



Telephone ports A0~C0 are ports 100~120.

# Station to Class of Service Feature Assignment

System Mode  
**4**

Submode  
**—**

Data No.  
**17**

PC Programming  
 + BTT









## General Description

Use this Memory Block to specify, per station, a class for each Table (1 and 2) to enable/disable features.

## Display

Tel Port No. (01~99) A0~C0	Data No.	Title	Table No. 1/2	Setting Service Class
01	/ 17	: C L S ( 1 )		= 0 0
T I M E D I S P L A Y				

## Programming Procedures

1	Go off-line.																		
2	Press LK4 +   to access the Memory Block.																		
3	<div style="float: right; border: 1px solid black; padding: 5px; width: fit-content;"> <b>Default Values</b> <table border="1" style="width: 100%; border-collapse: collapse; text-align: center;"> <thead> <tr> <th style="width: 20%;">Tel. No.</th> <th style="width: 30%;">Table No.</th> <th style="width: 50%;">Svc. Class</th> </tr> </thead> <tbody> <tr> <td rowspan="2">01</td> <td>1 ATTN</td> <td>00</td> </tr> <tr> <td>2 STA</td> <td>00</td> </tr> <tr> <td rowspan="2">02</td> <td>1 ATTN</td> <td>00</td> </tr> <tr> <td>2 STA</td> <td>00</td> </tr> <tr> <td rowspan="2">03 ~ C0</td> <td>1 ATTN</td> <td>15</td> </tr> <tr> <td>2 STA</td> <td>00</td> </tr> </tbody> </table> </div> <p>Use the dial pad to enter Service Class (00 ~ 15) for Table 1.</p> <p><b>Note:</b> Use the following to enter data:</p> <ul style="list-style-type: none"> <li> to move the cursor left</li> <li> to move the cursor right</li> <li> ~  for entering data</li> </ul>	Tel. No.	Table No.	Svc. Class	01	1 ATTN	00	2 STA	00	02	1 ATTN	00	2 STA	00	03 ~ C0	1 ATTN	15	2 STA	00
Tel. No.	Table No.	Svc. Class																	
01	1 ATTN	00																	
	2 STA	00																	
02	1 ATTN	00																	
	2 STA	00																	
03 ~ C0	1 ATTN	15																	
	2 STA	00																	
4	Press  to write the data and display Table 2 data.																		
5	Enter Table 2 Service Class, and press  again.																		
6	Press  to go back on-line.																		

## Related Programming

M.B. Number	Memory Block Name
<b>1-8-07</b>	Class of Service (Attendant) Feature Selection 1
<b>1-8-08</b>	Class of Service (Station) Feature Selection 2

# N

1. Table 1 includes features that telephone ports 01 and 02 users are normally allowed to activate. Select any Class pattern specified in Memory Block , 1-8-07 , Class of Service (Attendant) Feature Selection 1.
2. Table 2 includes features that all telephones users are normally allowed to activate. Select any Class pattern specified in Memory Block , 1-8-08 , Class of Service (Station) Feature Selection 2.
3. Telephone ports A0~C0 are ports 100~120.



# Station Name Assignment

## General Description

Use this Memory Block to assign names for telephone stations.

## Display

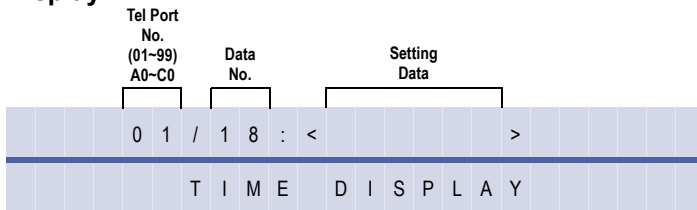











System Mode  
**4**

Submode  
—

Data No.  
**18**

PC Programming  
 + BTT

## Programming Procedures

<b>1</b>	Go off-line.	
<b>2</b>	Press LK4 +   to access the Memory Block.	
<b>3</b>	Use the dial pad to enter data. Refer to <i>Section 7, Character Code Tables</i> , and enter the 3-digit code to display each character.  <b>Note:</b> Use the following to enter data: <ul style="list-style-type: none"> <li> to move the cursor left</li> <li> to move the cursor right</li> <li> ~  to enter numeric data</li> <li> to clear all data when cursor is at setting data position</li> <li> to go to next Tel Port No.</li> </ul>	<b>Default Values</b> Not Specified
<b>4</b>	Press  to write the data.	
<b>5</b>	After entering all data, press  .	
<b>6</b>	Press  to go back on-line.	

## Related Programming

No related programming is necessary for this Memory Block.

- N**
1. While an internal line is ringing or in use, the station number and name of the other party are displayed.
  2. The name is not displayed when Tone Override, Automatic Callback, or Callback Request is displayed
  3. Only 6 digits/characters can be used for each name.
  4. Telephone ports A0~C0 are ports 100~120.

# Trunk Outgoing Restriction

## General Description

Use this Memory Block to specify, per CO/PBX line, whether or not to restrict line seizure for an outgoing call.

## Display

Tel Port No. (01-99) A0-C0	Data No.	Title	Page
0 1 / 1 9	:	T R K R S T	0 1
T I M E D I S P L A Y			

System Mode  
**4**

Submode  
—

Data No.  
**19**

PC Programming  
 + BTT

## Settings

### Page 1 (Ports 01~08)

LK 1	LK 2	LK 3	LK 4
01	02	03	04
LK 5	LK 6	LK 7	LK 8
05	06	07	08

### Page 2 (Ports 09~16)

LK 1	LK 2	LK 3	LK 4
09	10	11	12
LK 5	LK 6	LK 7	LK 8
13	14	15	16

### Page 3 (Ports 17~24)

LK 1	LK 2	LK 3	LK 4
17	18	19	20
LK 5	LK 6	LK 7	LK 8
21	22	23	24

There is no default setting.

### Page 4 (Ports 25~32)

LK 1	LK 2	LK 3	LK 4
25	26	27	28
LK 5	LK 6	LK 7	LK 8
29	30	31	32

### Page 5 (Ports 33~40)

LK 1	LK 2	LK 3	LK 4
33	34	35	36
LK 5	LK 6	LK 7	LK 8
37	38	39	40

### Page 6 (Ports 41~48)

LK 1	LK 2	LK 3	LK 4
41	42	43	44
LK 5	LK 6	LK 7	LK 8
45	46	47	48

**Settings**

**Page 7 (Ports 49~56)**











LK 1	LK 2	LK 3	LK 4
49	50	51	52
LK 5	LK 6	LK 7	LK 8
53	54	55	56

**Page 8 (Ports 57~64)**

LK 1	LK 2	LK 3	LK 4
57	58	59	60
LK 5	LK 6	LK 7	LK 8
61	62	63	64
29	30	31	32

There is no default setting.

**Programming Procedures**

1	Go off-line.							
2	Press LK4 +   to access the Memory Block.							
3	Press the CO/PBX line key corresponding to each CO/PBX line. The LED indication changes to indicate data each time a CO/PBX line key is pressed.	<p><b>Default Values</b> Off, Not Restricted.</p> <table border="1" style="margin-left: auto; margin-right: auto;"> <thead> <tr> <th style="text-align: center;">CO/PBX Line Key LED</th> <th style="text-align: center;">Off</th> <th style="text-align: center;">On</th> </tr> </thead> <tbody> <tr> <td style="text-align: center;">Data</td> <td style="text-align: center;">Not Restricted</td> <td style="text-align: center;">Restricted</td> </tr> </tbody> </table> <p><b>Note:</b> Use the following to enter data:   to move the cursor left   to move the cursor right   ~  to enter numeric data   to clear all data when cursor is at setting data position   to go to next Tel Port No.</p>	CO/PBX Line Key LED	Off	On	Data	Not Restricted	Restricted
CO/PBX Line Key LED	Off	On						
Data	Not Restricted	Restricted						
4	After entering all data for all pages, Press  to write the data.							
5	Press  to go back on-line.							

**Related Programming**

No related programming is necessary for this Memory Block.

**N**

1. A restricted CO/PBX line allows the station user to answer an incoming call or access a held call, but does not allow a user to originate a CO/PBX call.
2. If restricted is specified in this section, the data in Memory Blocks , 4-07 , Code Restriction Class Assignment (Day Mode) and Memory Block , 4-08 , Code Restriction Class Assignment (Night Mode) is treated as invalid even if specified.
3. Telephone ports A0~C0 are ports 100~120.

# Prime Line/Hot Line Assignment

System Mode	4
Submode	—
Data No.	23
PC Programming	 + BTT







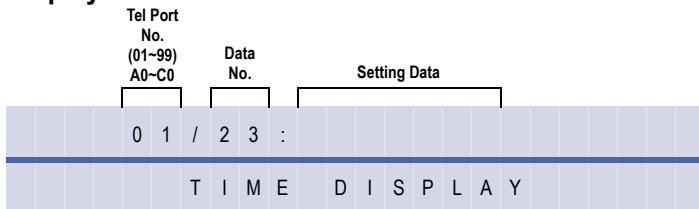



## General Description

Use this memory block to enable user to access various features when going off-hook.

## Display





## Programming Procedures

1	Go off-line.	
2	Press LK4 +   to access the Memory Block.	
3	Use dial pad to enter telephone number (10 Digits max.). <b>Note:</b> Use the following to enter data:  to move the cursor left  to move the cursor right  to enter numeric data  +  to input *  +  to input #	<b>Default Values</b> Not Specified
4	Press  to write the data.	
5	Press  to go back on-line.	

## Related Programming

No related programming is necessary for this Memory Block.

# N

1. Prime Line function enables a user to seize a specified trunk when the Multiline Terminal goes off-hook. Refer to function codes 063 and 064 for Memory Blocks , 1-1-46 , Access Code (1-Digit) Assignment and , 1-1-47 , Access Code (2-Digit) Assignment.
2. To call the specified station number or CO line on Hot Line, go off-hook.
3. When using Prime Line an access code (  +  ) must be entered to seize the intercom (ICM) for internal call processing.
4. To use Hot Line Assignment, one of the following must be entered:
  - Station Number
  - Access Code + Dial Number
  - Speed Dial Access Code + Speed Dial Buffer Number.
5. Only 10 digits can be assigned.
6. Telephone ports A0~C0 are ports 100~120.

# SLT Hookflash Assignment

## General Description

Use this memory block to specify the Single Line Telephone (SLT) hooking operation to either Hold or disconnect the trunk.

## Display

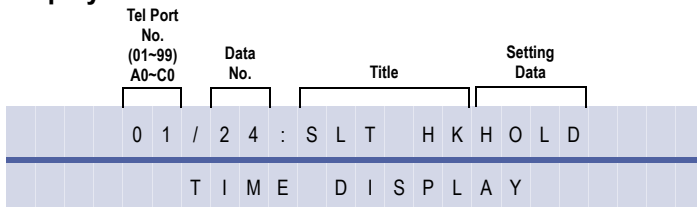

System Mode  
**4**

Submode  
—

Data No.  
**24**





PC Programming  
 + BTI

## Settings

LK 1	LK 2	LK 3	LK 4
Hold	Disc		
LK 5	LK 6	LK 7	LK 8

The shaded area indicates the default setting.

## Programming Procedures

1	Go off-line.
2	Press LK4 +   to access the Memory Block.
3	Press the corresponding CO/PBX line key to change data option. <b>Note:</b> Use the following to change option:  to go to next Tel Port No.
4	Press  to write the data.
5	Press  to go back on-line.

## Related Programming

M.B. Number	Memory Block Name
1-3-02	SLT Hookflash Signal Selection
4-23	Prime Line/Hot Line Assignment

# N

- This Memory Block affects only Single Line Telephone stations assigned Prime Line in Memory Block , 4-23 , Prime Line/Hot Line Assignment.
- When Prime Line is assigned to an Single Line Telephone, hookflash drops the CO and issues intercom (ICM) dial tone if this Memory Block is set to disconnect.
- After an SLT begins to dial out 9 +, hookflash follows Memory Block , 1-3-02 , SLT Hookflash Signal Selection selection.
- Telephone ports A0~C0 are ports 100~120.

# DISA/ID Number Station Assignment

System Mode  
**4**

Submode  
**—**

Data No.  
**26**

PC Programming  
 + BD









## General Description

Use this Memory Block to assign the Direct Inward System Access (DISA) ID Buffer Number corresponding to the station port number. The Station Message Detail Recording (SMDR) printout of the station number corresponds to the calling party who dialled the DISA ID number.

## Display

Station Port No. (01~99) A0~C0	Data No.	Title	Setting Data
01	/ 26	: I D N O .	= 0 1
T I M E D I S P L A Y			

## Programming Procedures

1	Go off-line.							
2	Press LK4 +   to access the Memory Block.							
3	Use the dial pad to assign DISA ID Buffer Number (01 ~ 96). <b>Note:</b> Use the following to enter data:  to move the cursor left  to move the cursor right  ~  to enter numeric data  to select next Station Port No.	<b>Default Values</b> <table border="1" style="width: 100%; border-collapse: collapse; margin-top: 10px;"> <thead> <tr> <th style="width: 50%;">Station Port Number</th> <th style="width: 50%;">DISA ID Buffer Number</th> </tr> </thead> <tbody> <tr> <td>01</td> <td>01</td> </tr> <tr> <td>02 ~ C0</td> <td>02 ~ C0</td> </tr> </tbody> </table>	Station Port Number	DISA ID Buffer Number	01	01	02 ~ C0	02 ~ C0
Station Port Number	DISA ID Buffer Number							
01	01							
02 ~ C0	02 ~ C0							
4	Press  to write the data.							
5	Press  to go back on-line.							

## Related Programming

M.B. Number	Memory Block Name
	Refer to <i>Chapter 2, Guide to Feature Programming.</i>



Telephone ports A0~C0 are ports 100~120.

# ID Outgoing Restriction Selection

## General Description

Use this Memory Block to specify which ID Numbers can be entered at each station to override Code Restriction.

## Display

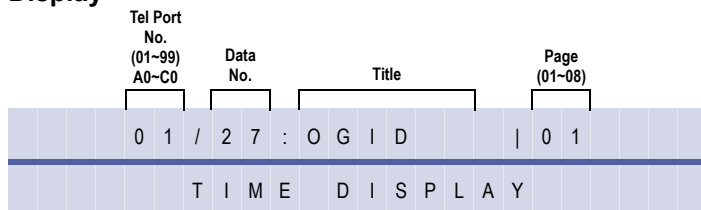

System Mode  
**4**

Submode  
—

Data No.  
**27**

PC Programming  
 + BTT

## Settings

### Page 1 (ID No. 01)

LK 1	LK 2	LK 3	LK 4
01	02	03	04
LK 5	LK 6	LK 7	LK 8
05	06	07	08

### Page 2 (ID No. 09)

LK 1	LK 2	LK 3	LK 4
09	10	11	12
LK 5	LK 6	LK 7	LK 8
13	14	15	16

### Page 3 (ID No. 17)

LK 1	LK 2	LK 3	LK 4
17	18	19	20
LK 5	LK 6	LK 7	LK 8
21	22	23	24

The shaded area indicates the default setting.

### Page 4 (ID No. 25)

LK 1	LK 2	LK 3	LK 4
25	26	27	28
LK 5	LK 6	LK 7	LK 8
29	30	31	32

### Page 5 (ID No. 33)

LK 1	LK 2	LK 3	LK 4
33	34	35	36
LK 5	LK 6	LK 7	LK 8
37	38	39	40

### Page 6 (ID No. 41)

LK 1	LK 2	LK 3	LK 4
41	42	43	44
LK 5	LK 6	LK 7	LK 8
45	46	47	48

**Settings****Page 7 (ID No. 49)**

LK 1	LK 2	LK 3	LK 4
49	50	51	52
LK 5	LK 6	LK 7	LK 8
53	54	55	56

**Page 8 (ID No. 57)**

LK 1	LK 2	LK 3	LK 4
57	58	59	60
LK 5	LK 6	LK 7	LK 8
61	62	63	64

**Page 9 (ID No. 65)**

LK 1	LK 2	LK 3	LK 4
65	66	67	68
LK 5	LK 6	LK 7	LK 8
69	70	71	72

**Page 10 (ID No. 73)**

LK 1	LK 2	LK 3	LK 4
76	74	75	76
LK 5	LK 6	LK 7	LK 8
77	78	79	80

**Page 11 (ID No. 81)**

LK 1	LK 2	LK 3	LK 4
81	82	83	84
LK 5	LK 6	LK 7	LK 8
85	86	87	88

The shaded area indicates the default setting.

**Page 12 (ID No. 89)**

LK 1	LK 2	LK 3	LK 4
89	90	91	92
LK 5	LK 6	LK 7	LK 8
93	94	95	96

**Page 13 (ID No. 97)**

LK 1	LK 2	LK 3	LK 4
97	98	99	100
LK 5	LK 6	LK 7	LK 8
101	102	103	104

**Page 14 (ID No. 105 [A5])**











LK 1	LK 2	LK 3	LK 4
105	106	107	108
LK 5	LK 6	LK 7	LK 8
109	110	111	112

**Page 15 (ID No. 113 [B3])**

LK 1	LK 2	LK 3	LK 4
113	114	115	116
LK 5	LK 6	LK 7	LK 8
117	118	119	120



**Programming Procedures**

1	Go off-line.							
2	Press LK4 +   to access the Memory Block.							
3	<p>Press the CO/PBX Line key corresponding to each CO/PBX number. The LED indication changes to indicate data each time a CO/PBX line key is pressed.</p> <table border="1" style="margin-left: 20px;"> <tr> <td style="text-align: center;"><b>CO/PBX Line Key LED</b></td> <td style="text-align: center;"><b>Off</b></td> <td style="text-align: center;"><b>On</b></td> </tr> <tr> <td style="text-align: center;"><b>Meaning</b></td> <td style="text-align: center;"><b>Not Available</b></td> <td style="text-align: center;"><b>Available</b></td> </tr> </table> <p><b>Note:</b> Use the following to enter data:   to move the cursor left   to move the cursor right   to move to the next Tel No.   to move to the next page   to move to the previous page   +1, 2, 3 = A, B or C for Port Number</p> <p><b>Tel Port Number:</b>  01~99 = 01~99  A0~A9 = 100~109  B0~B9 = 110~119  C0 = 120</p>	<b>CO/PBX Line Key LED</b>	<b>Off</b>	<b>On</b>	<b>Meaning</b>	<b>Not Available</b>	<b>Available</b>	<p><b>Default Values</b> All stations = Available for all ID Numbers.</p>
<b>CO/PBX Line Key LED</b>	<b>Off</b>	<b>On</b>						
<b>Meaning</b>	<b>Not Available</b>	<b>Available</b>						
4	After entering all data for all pages, press  to write the data.							
5	Press  to go back on-line.							

**Related Programming**

M.B. Number	Memory Block Name
1-1-19	Line Selection for Automatic Outgoing Calls
1-1-46	DID Digit Length Selection
1-1-47	DID Digit Conversion Assignment
1-1-48	DID Forward Station Number for Busy Station or Undefined Digit
1-5-23	Outgoing Mode Selection
1-9-00	DISA/ID Code Assignment
1-9-02	DISA/ID Password Effect/Invalid Selection
1-9-03	ID Restriction Class Assignment (Day Mode)
4-26	DISA/ID Number Station Assignment



Telephone ports A0~C0 are ports 100~120.

# Multilingual LCD Indication Selection

## General Description

Use this Memory Block to specify whether Japanese, French, English or Spanish is displayed on the Multiline Terminal LCD.

## Display

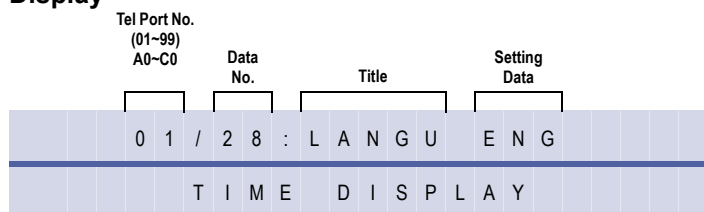

*System Mode*  
**4**

*Submode*  
**—**

*Data No.*  
**28**





*PC Programming*  
 + BTM

## Settings

LK 1	LK 2	LK 3	LK 4
JAPA	FREN	ENG	SPAN
LK 5	LK 6	LK 7	LK 8

The shaded area indicates the default setting.

## Programming Procedures

1	Go off-line.
2	Press LK4 +   to access the Memory Block.
3	Press the corresponding CO/PBX line key to change language option.
4	Press  to write the data.
5	Press  to go back on-line.

## Related Programming

No related programming is necessary for this Memory Block.



Telephone ports A0~C0 are ports 100~120.

# HFU Selection

## General Description

Use this memory block to enable/disable (per station) the built-in Handsfree operation of Multiline terminals.

## Display

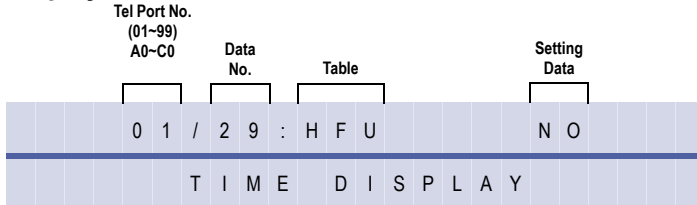

System Mode  
**4**

Submode  
—

Data No.  
**29**





PC Programming  
 + BTM

## Settings

LK 1	LK 2	LK 3	LK 4
No	Yes		
LK 5	LK 6	LK 7	LK 8

The shaded area indicates the default setting.

## Programming Procedures

- 1 Go off-line.
- 2 Press LK4 +   to access the Memory Block.
- 3 Press the corresponding CO/PBX line key to change data option.
- 4 Press  to write the data.
- 5 Press  to go back on-line.

## Related Programming

No related programming is necessary for this Memory Block.

# N

Telephone ports A0~C0 are ports 100~120.

# Hold/Transfer Recall Display Selection

## General Description

Use this memory block to enable/disable the Hold Recall indication on the LCD.

## Display

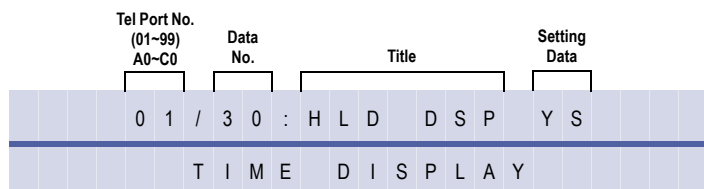

System Mode  
**4**

Submode  
**—**

Data No.  
**30**

PC Programming  
**Alt + BTM**

## Settings

LK 1	LK 2	LK 3	LK 4
Ys	No		
LK 5	LK 6	LK 7	LK 8

The shaded area indicates the default setting.

## Programming Procedures

- 1 Go off-line.
- 2 Press LK4 + to access the Memory Block.
- 3 Press the corresponding CO/PBX line key to change data option.
- 4 Press to write the data.
- 5 Press to go back on-line.

## Related Programming

No related programming is necessary for this Memory Block.



1. If this Memory Block is assigned Yes, the Hold Recall is displayed in place of the Time Display.
2. LCD indication of the CO line number is displayed on the upper line of the display when a recall occurs, regardless of the assignment for this Memory Block.
3. Telephone ports A0~C0 are ports 100~120.

# Receiving Internal/All Call Page Selection

## General Description

Use this memory block to enable/disable (per station) receiving an Internal Zone or Internal All Zone Page.

## Display

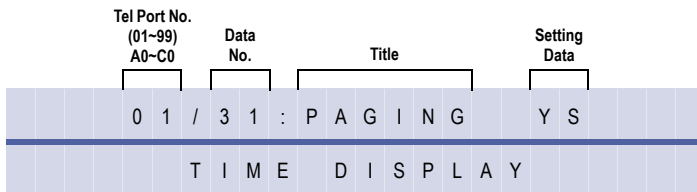

## Settings

LK 1	LK 2	LK 3	LK 4
Ys	No		
LK 5	LK 6	LK 7	LK 8

The shaded area indicates the default setting.

## Programming Procedures

1	Go off-line.
2	Press LK4 +   to access the Memory Block.
3	Press the corresponding CO/PBX line key to change data option.
4	Press  to write the data.
5	Press  to go back on-line.

## Related Programming

No related programming is necessary for this Memory Block.

System Mode  
**4**  
 Submode  
 —  
 Data No.  
**31**  
 PC Programming  
 + BTT

# N

1. Internal Emergency All Call Page and Internal Paging by Tenant Group overrides this Memory Block. Refer to Memory Block , 1-1-46 , Access Code (1-Digit) Assignment.
2. Telephone ports A0~C0 are ports 100~120.

# Trunk Digit Restriction

## General Description

Use this Memory Block to specify the maximum number of digits per station that can be dialled while on any outside line.

## Display

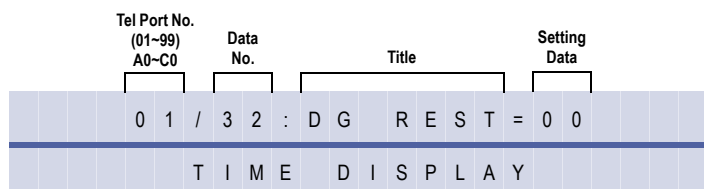







System Mode  
**4**

Submode  
**—**

Data No.  
**32**

PC Programming  
 + BTT

## Programming Procedures

<b>1</b>	Go off-line.	
<b>2</b>	Press LK4 +   to access the Memory Block.	
<b>3</b>	Use the dial pad to enter Setting Data (00 ~ 99 digits). <b>Note:</b> Use the following to enter data:  ~  to enter numeric data  to select next Tel Port No.	<b>Default Values</b> 00 (No Limit)
<b>4</b>	Press  to write the data.	
<b>5</b>	Press  to go back on-line.	

## Related Programming

M.B. Number	Memory Block Name
	Refer to <i>Section 6, Code Restriction</i> in this chapter.

# N

1. Code Restriction must be assigned before this feature is used.
2. Trunk Digit Restriction applies to all CO/PBX lines.
3. Tie Line Code Restriction must be assigned before this feature works on Tie lines.
4. Telephone ports A0~C0 are ports 100~120.

# Voice Mail/SLT Selection

## General Description

Use this memory block to specify whether or not a Voice Mail system is interfaced with the system for Single Line Telephone ports.

## Display

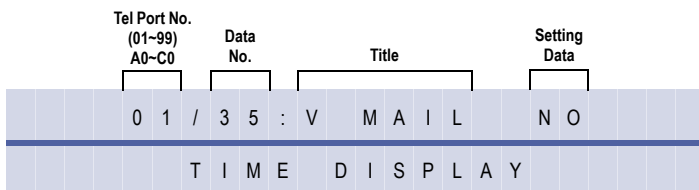

System Mode  
**4**

Submode  
—

Data No.  
**35**

PC Programming  
 + BTI

## Settings

LK 1	LK 2	LK 3	LK 4
No	Yes		
LK 5	LK 6	LK 7	LK 8

The shaded area indicates the default setting.

## Programming Procedures

- 1 Go off-line.
- 2 Press LK4 + to access the Memory Block.
- 3 Press the corresponding CO/PBX line key to change data option.  
**Note:** Use the following to change option:  
Press to go to next Tel Port No.
- 4 Press to write the data.
- 5 Press to go back on-line.

## Related Programming

M.B. Number	Memory Block Name
7-2	Telephone Type Assignment.

## N

1. The SLT(1)-U( ) ADP Adapter and the ADA(2)-W(BK)/(SW) Unit do not support Voice Mail.
2. Only 16 Voice Mail ports are supported by this system.
3. Telephone ports A0~AC are ports 100~120.

# Voice Prompt Selection

## General Description

Use this memory block to specify, per station, whether to allow or deny Voice Prompt.

## Display

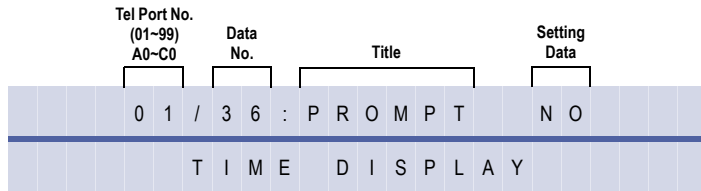

System Mode  
**4**

Submode  
—

Data No.  
**36**

PC Programming  
 + BTT

## Settings

LK 1	LK 2	LK 3	LK 4
No	Yes		
LK 5	LK 6	LK 7	LK 8

The shaded area indicates the default setting.

## Programming Procedures

- 1 Go off-line.
- 2 Press LK4 + to access the Memory Block.
- 3 Press the corresponding CO/PBX line key to change data option.  
**Note:** Use the following to change option:  
Press to go to next Tel Port No.
- 4 Press to write the data.
- 5 Press to go back on-line.

## Related Programming

M.B. Number	Memory Block Name
	Refer to <i>Chapter 2, Guide to Feature Programming</i> .



Telephone ports A0~C0 are ports 100~120.



# Extension Line Key Ring Assignment (Day Mode)

## General Description

Use this Memory Block to specify the ringing assignment on incoming calls to a Secondary Incoming Extension (SIE) or a Call Arrival key.

## Display

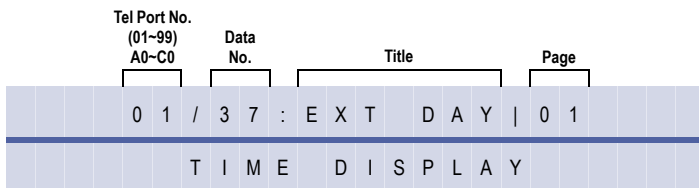

System Mode  
4  
Submode  
—  
Data No.  
37  
PC Programming  
Alt + BTM

## Settings

### Page 1 (Line Keys 01~08)

LK 1	LK 2	LK 3	LK 4
1	2	3	4
LK 5	LK 6	LK 7	LK 8
5	6	7	8

### Page 2 (Line Keys 09~16)

LK 1	LK 2	LK 3	LK 4
9	10	11	12
LK 5	LK 6	LK 7	LK 8
13	14	15	16

There is no default setting.

### Page 3 (Line Keys 17~24)

LK 1	LK 2	LK 3	LK 4
17	18	19	20
LK 5	LK 6	LK 7	LK 8
21	22	23	24

## Programming Procedures

1	Go off-line.									
2	Press LK4 +   to access the Memory Block.									
3	Use the dial pad to select option. The LED indication changes to indicate data each time a CO/PBX line key is pressed.	<b>Default Values</b> All Telephones: No Ring								
	<table border="1"> <tr> <th>CO/PBX Line Key LED</th> <th>Off</th> <th>Green</th> <th>Red</th> </tr> <tr> <td>Data</td> <td>No ring</td> <td>Immediate Ring</td> <td>Delayed Ring</td> </tr> </table>	CO/PBX Line Key LED	Off	Green	Red	Data	No ring	Immediate Ring	Delayed Ring	
CO/PBX Line Key LED	Off	Green	Red							
Data	No ring	Immediate Ring	Delayed Ring							
	<b>Note:</b> Use the following to enter data: go to next page go to previous page to select next Tel Port No.									
4	Press  to write the data.									
5	Press  to go back on-line.									

**Related Programming**

M.B. Number	Memory Block Name
1-2-26	Delayed Ringing Timer Assignment (ICM)

---

**N**

1. When Ring is set, the LED is green.
2. This Memory Block applies only when an SIE or Call Arrival key is programmed for line key appearance.
3. Telephone ports A0~C0 are ports 100~120.

# Extension Line Key Ring Assignment (Night Mode)

## General Description

Use this Memory Block to specify the ringing assignment on incoming calls to a Secondary Incoming Extension (SIE) or a Call Arrival key.

## Display

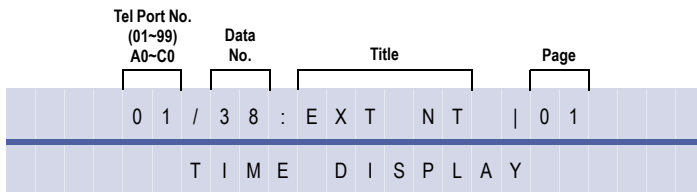

## Settings

### Page 1 (Line Keys 01~08)

LK 1	LK 2	LK 3	LK 4
1	2	3	4
LK 5	LK 6	LK 7	LK 8
5	6	7	8

### Page 2 (Line Keys 09~16)

LK 1	LK 2	LK 3	LK 4
9	10	11	12
LK 5	LK 6	LK 7	LK 8
13	14	15	16

There is no default setting.

### Page 3 (Line Keys 17~24)

LK 1	LK 2	LK 3	LK 4
17	18	19	20
LK 5	LK 6	LK 7	LK 8
21	22	23	24

## Programming Procedures

- Go off-line.
- Press LK4 + to access the Memory Block.
- Use the dial pad to enter data.
 

Default Values			
All Telephones: No Ring			

The LED indication changes to indicate data each time a CO/PBX line key is pressed.

CO/PBX Line Key LED	Off	Green	Red
Data	No ring	Immediate Ring	Delayed Ring

**Note:** Use the following to enter data:

  - go to next page
  - go to previous page
  - select next Tel Port No.

System Mode  
**4**

Submode  
—

Data No.  
**38**

PC Programming  
 + BTM

**Programming Procedures (Continued)**

4	Press  to write the data.
5	Press  to go back on-line.

**Related Programming**

M.B. Number	Memory Block Name
1-2-26	Delayed Ringing Timer Assignment (ICM)

**N**

1. When Ring is set, the LED is green.
2. This Memory Block applies only when an SIE or Call Arrival key is programmed for line key appearance.
3. Telephone ports A0~C0 are ports 100~120.

# APR Ring Mode Assignment

## General Description

Use this Memory Block to specify the ringing mode for an Single Line Telephone connected to the APR-U.

## Display

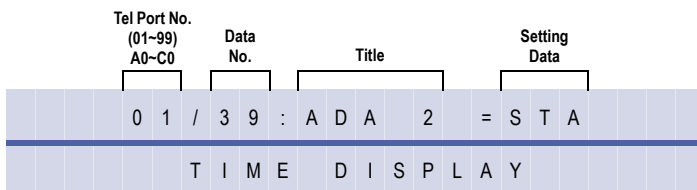

System Mode  
**4**

Submode  
—

Data No.  
**39**





PC Programming  
 + BTM

## Settings

LK 1	LK 2	LK 3	LK 4
No Ring	Station Number only	All Ring	
LK 5	LK 6	LK 7	LK 8

The shaded area indicates the default setting.

## Programming Procedures

<b>1</b>	Go off-line.
<b>2</b>	Press LK4 +   to access the Memory Block.
<b>3</b>	Press the corresponding CO/PBX line key to change data option. <b>Note:</b> Use the following to enter data:  select next Tel Port No.
<b>4</b>	Press  to write the data.
<b>5</b>	Press  to go back on-line.

## Related Programming

No related programming is necessary for this Memory Block.

# N

- No Ring means that no calls ring at the Single Line Telephone.
- Station Number ring means that only calls directed to the Multiline Terminal Station Number, ring at the Single Line Telephone.
- All Ring means that all calls that ring at the Multiline Terminal also ring at the Single Line Telephone.
- Telephone ports A0~C0 are ports 100~120.

# LCR Class Selection

## General Description

Use this Memory Block to specify, per station, the Least Cost Routing (LCR) Class. The Xen IPK has four Area Code Tables. Each LCR Class can have different Trunk Group access to allow priority levels for the station user.

## Display

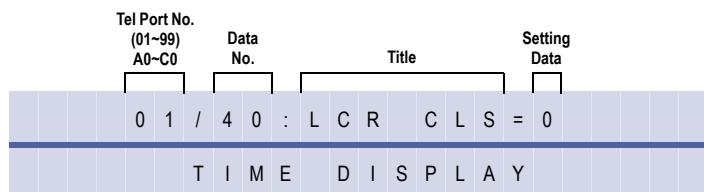

*System Mode*  
**4**

*Submode*  
—

*Data No.*  
**40**





*PC Programming*  
 + BTT

## Settings

LK 1	LK 2	LK 3	LK 4
Class 0	Class 1	Class 2	Class 3
LK 5	LK 6	LK 7	LK 8
Class 4			

The shaded area indicates the default setting.

## Programming Procedures

- 1 Go off-line.
- 2 Press LK4 +   to access the Memory Block.
- 3 Press the corresponding CO/PBX line key to change data option.  
**Note:** Use the following to change option:  
 to select next Tel Port No.
- 4 Press  to write the data.
- 5 Press  to go back on-line.

## Related Programming

No related programming is necessary for this Memory Block.

# N

1. LCR Class Selection corresponds to Area Code Tables as follows:
  - Class 0 No LCR
  - Class 1 Use Area Code Table 1
  - Class 2 Use Area Code Table 2
  - Class 3 Use Area Code Table 3
  - Class 3 Use Area Code Table 3
2. Stations cannot be assigned to multiple LCR Classes.
3. An MIFM PAL must be installed in the system to support this feature.
4. Telephone ports A0~C0 are ports 100~120.
5. Access Code must always be used in order to access LCR Trunk Group 1.

# SIE/CAR Ringing Line Preference Selection

## General Description

Use this Memory Block to specify whether to allow/deny Ringing Line Preference (go off-hook or press Speaker key) on all telephones that are assigned Secondary Incoming Extension (SIE) and/or Call Arrival keys.

## Display

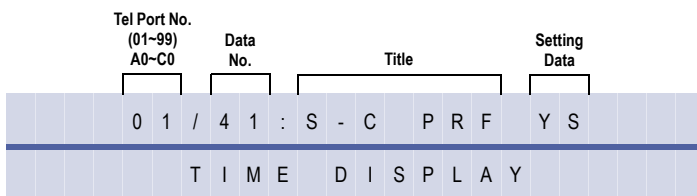

## Settings

LK 1	LK 2	LK 3	LK 4
No	Yes		
LK 5	LK 6	LK 7	LK 8

The shaded area indicates the default setting.

## Programming Procedures

1	Go off-line.
2	Press LK4 +   to access the Memory Block.
3	Press the corresponding CO/PBX line key to change data option. <b>Note:</b> Use the following to change option: select next Tel Port No.
4	Press  to write the data.
5	Press  to go back on-line.

## Related Programming

M.B. Number	Memory Block Name
4-37	Extension Line Key Ring Assignment (Day Mode)
4-38	Extension Line Key Ring Assignment (Night Mode)

## N

1. Telephone ports A0~C0 are ports 100~120.
2. The SIE/CAR must be ringing for this Memory Block to work.

System Mode  
**4**

Submode  
—

Data No.  
**41**

PC Programming  
 + BTM

# Call Forward-Busy Immediately/Delay Selection

## General Description

Use this Memory Block to specify immediate forward (No) or delay forward (Yes) for an Incoming CO/PBX call if the station is set for Call Forward Busy.

## Display

Tel Port No. (01~99) A0~C0	Data No.	Title	Setting Data
0 1 / 4 2	:	B U S Y F W D	N O
T I M E D I S P L A Y			

System Mode  
**4**

Submode  
**—**

Data No.  
**42**





PC Programming  
 + BTT

## Settings

LK 1	LK 2	LK 3	LK 4
No	Yes		
LK 5	LK 6	LK 7	LK 8

The shaded area indicates the default setting.

## Programming Procedures

- 1 Go off-line.
- 2 Press LK4 +   to access the Memory Block.
- 3 Press the corresponding CO/PBX line key to change data option.  
**Note:** Use the following to change option:  
 to select next Tel Port No.
- 4 Press  to write the data.
- 5 Press  to go back on-line.

## Related Programming

M.B. Number	Memory Block Name
1-2-22	Call Forward No Answer Timer Selection



Telephone ports A0~C0 are ports 100~120.



# Station to Call Appearance Block Assignment

## General Description

Use this Memory Block to assign a Multiline Terminal to a Call Appearance Block.

## Display

Tel Port No. (01~99) A0~C0	Data No.	Title	Setting Data
0 1 /	4 3	: C A P	N O 0 0
T I M E D I S P L A Y			









System Mode  
**4**

Submode  
—

Data No.  
**43**

PC Programming  
 + BTT

## Programming Procedures

<b>1</b>	Go off-line.	
<b>2</b>	Press LK4 +   to access the Memory Block.	
<b>3</b>	Use the dial pad to enter Call Appearance Block (00 ~ 47). <b>Note:</b> Use the following to enter data: <ul style="list-style-type: none"> <li> to move the cursor left</li> <li> to move the cursor right</li> <li> ~  to enter numeric data</li> <li> to select next Tel Port No.</li> </ul>	<b>Default Values</b> All stations are assigned to Call Appearance Block 00.
<b>4</b>	Press  to write the data.	
<b>5</b>	Press  to go back on-line.	

## Related Programming

M.B. Number	Memory Block Name
	Refer to <i>Chapter 2, Guide to Feature Programming</i> .

# N

Telephone ports A0~C0 are ports 100~120.

# Caller ID/Preset Dial Outgoing CO Selection

*System Mode*  
**4**

*Submode*  
—

*Data No.*  
**44**

*PC Programming*  
 + AI







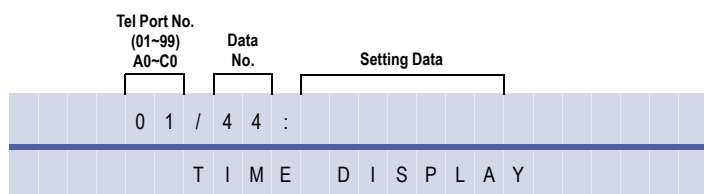

## General Description

Use this Memory Block to assign the Trunk Group, Route Advanced Group, or Closed Numbering Group that is seized for Caller ID Outgoing Calls and preset dial. Use the Caller ID Scroll key to access the Caller ID to be called.

## Display



## Programming Procedures

<b>1</b>	Go off-line.		
<b>2</b>	Press LK4 +   to access the Memory Block.		
<b>3</b>	Use the dial pad to enter Setting Data. <b>Note:</b> Use the following to enter data: <ul style="list-style-type: none"> <li> to move the cursor left</li> <li> to move the cursor right</li> <li> ~  to enter numeric data</li> <li> to select next Tel Port No.</li> </ul>	<b>Default Values</b> Not specified	
<b>4</b>	Press  to write the data.		
<b>5</b>	Press  to go back on-line.		

## Related Programming

No related programming is necessary for this Memory Block.

# N

1. Setting Data is Access Code Assignment in Memory Blocks , 1-1-46, , 1-1-47, , 1-1-48 Access Code (1-Digit, 2-Digit, or 3-Digit) Assignment. For example: Dial 9 (101) → Trunk Group 1.
2. Assign the Caller ID Scroll key using Memory Blocks , 2-06 , Line Key Selection for Tenant Mode or , 4-12 , Line Key Selection for Telephone Mode.
3. Telephone ports A0~C0 are ports 100~120.

# Live Record Auto Delete

## General Description

This Memory Block controls whether live record sessions that are not addressed by the station user are deleted or not.

## Display

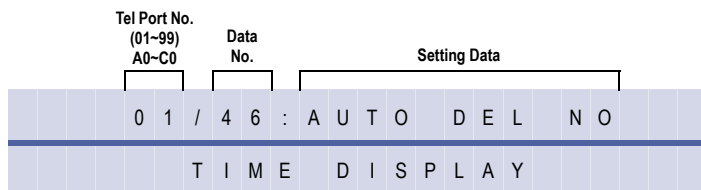









System Mode  
**4**  
 Submode  
 —  
 Data No.  
**46**  
 PC Programming  
 + AV

## Settings

LK 1	LK 2	LK 3	LK 4
Yes	No		
LK 5	LK 6	LK 7	LK 8

The shaded area indicates the default setting.

## Programming Procedures

1	Go off-line.	
2	Press LK4 +   to access the Memory Block.	
3	Use the Line Keys to enter the Live Record Message Control Selection. <b>Note:</b> Use the following to enter data:  to move the cursor left  to move the cursor right  ~  to enter numeric data  to select next Tel Port No.	<b>Default Values</b> No
4	Press  to write the data.	
5	Press  to go back on-line.	

## Related Programming

No related programming is necessary for this Memory Block.

# ISDN Directory Number Selection

## General Description

This Memory Block specifies whether or not the directory Number is presented to the Network when a call is placed from the programmed station.

## Display

Tel Port No. (01-CO)	Data No.	Title	Setting Data
0 1 /	4 7	: C - I D	Y E S
T I M E D I S P L A Y			

System Mode  
**4**

Submode  
**—**

Data No.  
**47**





PC Programming  
 + AN

## Settings

LK 1	LK 2	LK 3	LK 4
Yes	No		
LK 5	LK 6	LK 7	LK 8

The shaded area indicates the default setting.

## Programming Procedures

- 1 Go off-line.
- 2 Press LK4 +   to access the Memory Block.
- 3 Press the corresponding CO/PBX line key to change the Setting Data option.
- 4 Press  to write the data and display the next Memory Block.
- 5 Program the next Memory Block or press  to go back on-line.

## Related Programming

M.B. Number	Memory Block Name
<b>3-53</b>	ISDN Trunk Directory Number Assignment
<b>3-91</b>	Trunk Type Selection
<b>4-62</b>	ISDN Extension-based Caller ID Assignment

---

# N

**BRI:**

1. When this Memory Block is set to No, the station placing an outgoing call does not present the programmed number in Memory Block 3-52 assigned for the BRI Trunks. The Network presents Restricted for the Caller ID information.
2. When this Memory Block is set to YES, the station placing an outgoing call presents the programmed number in Memory Block 3-52 assigned for the BRI Trunks. The Network presents the programmed number as Caller ID.

**PRI:**

1. When this Memory Block is set to No, and ISDN-PRI is used in CO Mode in Memory Block 3-91, the programmed number in Memory Block 3-52 is not presented as Caller ID. The Network presents Restricted for the Caller ID information.
2. When this Memory Block is set to YES, and ISDN-PRI is used in CO Mode in Memory Block 3-91, the programmed number in Memory Block 3-52 is presented as Caller ID. The Network presents the programmed number as Caller ID.
3. When this Memory Block is set to No, and ISDN-PRI is used in DID Mode in Memory Block 3-91, the programmed number in Memory Block 3-52 is not presented as Caller ID.
4. When this Memory Block is set to YES, and ISDN-PRI is used in DID Mode in Memory Block 3-91, the programmed number in Memory Block 4-62 is presented as Caller ID. The Network presents the programmed number as Caller ID.

# Caller ID Display for CAR Key

## General Description

This Memory Block assigns one Multiline Terminal per CAR to display Caller ID Indication on incoming CAR calls.

This memory block is not applicable to IPK R2000 and above.

## Display

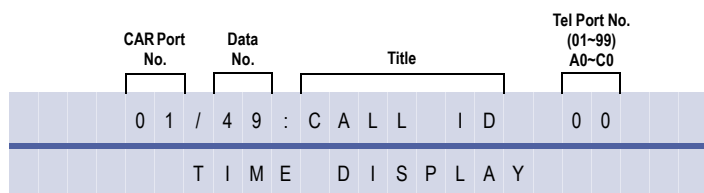

System Mode  
**4**

Submode  
—

Data No.  
**49**

PC Programming  
 + AI

## Programming Procedures

1	Go off-line.	
2	Press LK1 + LK10 +   to access the Memory Block.	
3	Use the dial pad to enter Setting Data. <b>Note:</b> Use the following to enter data: <ul style="list-style-type: none"> <li> to move the cursor left</li> <li> to move the cursor right</li> <li> ~  to enter numeric data</li> <li> to select next CAR No.</li> </ul>	<b>Default Values</b> Not Specified
4	Press  to write the data.	
5	Press  to go back on-line.	

## Related Programming

No related programming is necessary for this Memory Block.

**N**

To display Caller ID Indication for normal incoming CO calls and CAR incoming calls, both Caller ID Indication and Ring assignment must be assigned for the terminal in System Programming. A maximum of 15 Multiline Terminals can be assigned system-wide to display caller identification for normal incoming CO calls and CAR incoming calls using Memory Block , 1-1-78 , Caller ID Display Assignment for System Mode. A sixteenth Multiline Terminal can be assigned to display caller identification for CAR incoming calls per CAR using this Memory Block.

# Multiline Terminal Type Selection

## General Description

This Memory Block is used to assign a DTU-32D-1A (BK)/(WH), or DTR-32D-1A (BK)/(WH) TEL with 16 line keys or 24 line keys.

## Display

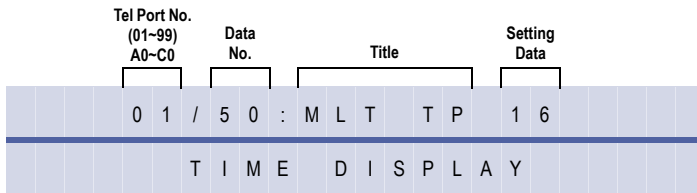

## Settings

LK 1	LK 2	LK 3	LK 4
16	24	24A	
LK 5	LK 6	LK 7	LK 8

The shaded area indicates the default setting.

## Programming Procedures

1	Go off-line.	
2	Press LK4 +   to access the Memory Block.	
3	Use line keys to assign 16 or 24 line keys.	<b>Default Values</b> All stations have 16 line keys.
4	Press  to write the data.	
5	Press  to go back on-line.	

## Related Programming

No related programming is necessary for this Memory Block.

System Mode  
4  
Submode  
—  
Data No.  
50  
PC Programming  
 + BTM



Telephone ports A0~C0 are ports 100~120.

**Line Key Orientation**

LK = Line Keys

OT = One-Touch

**DTUD-32D-1A TEL Keys**

16 Line Key Type

LK1	LK2	LK3	LK4	OT 1	OT 9
LK5	LK6	LK7	LK8	OT 2	OT 10
LK9	LK10	LK11	LK12	OT 3	OT 11
LK13	LK14	LK15	LK16	OT 4	OT 12
				OT 5	OT 13
				OT 6	OT 14
				OT 7	OT 15
				OT 8	OT 16

24 Line Key Type

LK1	LK2	LK3	LK4	LK17	LK21
LK5	LK6	LK7	LK8	LK18	LK22
LK9	LK10	LK11	LK12	LK19	LK23
LK13	LK14	LK15	LK16	LK20	LK24
				OT 1	OT 5
				OT 2	OT 6
				OT 3	OT 7
				OT 4	OT 8

LK01	LK02	LK03	LK04	LK17	OTK1
LK05	LK06	LK07	LK08	LK18	OTK2
LK9	LK10	LK11	LK12	LK19	OTK3
LK13	LK14	LK15	LK16	LK20	OTK4
				LK21	OTK5
				LK22	OTK6
				LK23	OTK7
				LK24	OTK8

**DTR-32D-1A TEL**

16 Line Key Mode

LK1	LK2	LK3	LK4	LK5	LK6	LK7	LK8
LK9	LK10	LK11	LK12	LK13	LK14	LK15	LK16
OT1	OT2	OT3	OT4	OT5	OT6	OT7	OT8
OT9	OT10	OT11	OT12	OT13	OT14	OT15	OT16

24 Line Key Mode

LK1	LK2	LK3	LK4	LK5	LK6	LK7	LK8
LK9	LK10	LK11	LK12	LK13	LK14	LK15	LK16
LK17	LK18	LK19	LK20	OT1	OT2	OT3	OT4
LK21	LK22	LK23	LK24	OT5	OT6	OT7	OT8

24A Line Key Mode

LK1	LK2	LK3	LK4	LK5	LK6	LK7	LK8
LK9	LK10	LK11	LK12	LK13	LK14	LK15	LK16
LK17	LK18	LK19	LK20	LK21	LK22	LK23	LK24
OT1	OT2	OT3	OT4	OT5	OT6	OT7	OT8





# Off-Hook Ringing Selection

## General Description

Use this Memory Block to assign Off-Hook Ringing to Multiline Terminals per station.

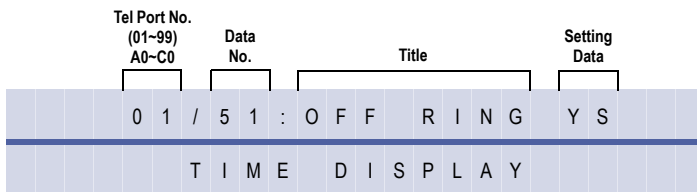
## Display











System Mode  
**4**  
 Submode  
 —  
 Data No.  
**51**  
 PC Programming  
 + BTM

## Settings

LK 1	LK 2	LK 3	LK 4
Ys	No		
LK 5	LK 6	LK 7	LK 8

The shaded area indicates the default setting.

## Programming Procedures

1	Go off-line.	
2	Press LK4 +   to access the Memory Block.	
3	Use the Line Keys to enter the Off-Hook Ringing Selection. <b>Note:</b> Use the following to enter data:  to move the cursor left  to move the cursor right  ~  to enter numeric data  to select next Tel Port No.	<b>Default Values</b> All terminals = YS
4	Press  to write the data.	
5	Press  to go back on-line.	

## Related Programming

No related programming is necessary for this Memory Block.



Telephone ports A0~C0 are ports 100~120.

# CO/PBX Answer Key Operation without Ringing

System Mode  
**4**

Submode  
**—**

Data No.  
**52**

PC Programming  
 + BTT

## General Description

This Memory Block is used to disable Ring Assigned telephones from ringing during Day and allowing Message Waiting and Answer Key to blink, therefore allowing calls to be answered.

## Display

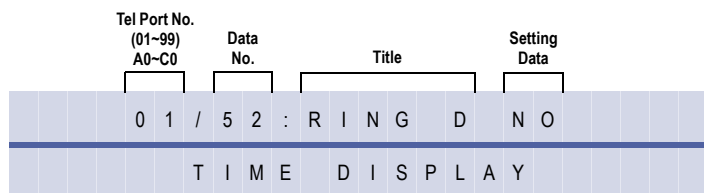





## Settings

LK 1	LK 2	LK 3	LK 4
NO	YS		
LK 5	LK 6	LK 7	LK 8

The shaded area indicates the default setting.

## Programming Procedures

- 1 Go off-line.
- 2 Press LK4 +   to access the Memory Block.
- 3 Press the corresponding CO/PBX line key to change language option.
- 4 Press  to write the data.
- 5 Press  to go back on-line.

## Related Programming

M.B. Number	Memory Block Name
4-01	CO/PBX Ring Assignment (Day Mode)
4-02	CO/PBX Ring Assignment (Night Mode)



1. Telephone ports A0~C0 are ports 100~120.
2. Setting to YES - the telephone will ring for all Ring Assigned lines set in Memory Blocks , 4-01 and , 4-02.
3. Setting to NO - the telephone will not ring for any Ring Assigned lines however the Message Waiting Lamp and Answer Key will flash. When NO is selected neither Caller ID nor Trunk Name Assignment will be displayed.

# CO/PBX Answer Key Operation with-out Ringing Assignment (Night Mode)

System Mode  
**4**

Submode  
—

Data No.  
**53**

PC Programming  
 + **BTT**

### General Description

This Memory Block is used to disable Ring Assigned telephones from ringing during Night and allowing Message Waiting and Answer Key to blink, therefore allowing calls to be answered.

### Display

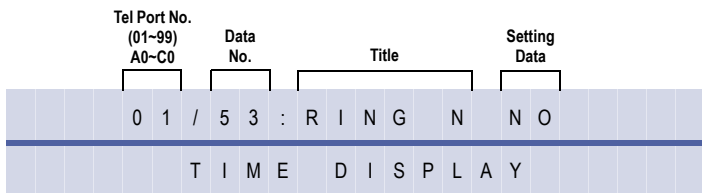





### Settings

LK 1	LK 2	LK 3	LK 4
NO	YS		
LK 5	LK 6	LK 7	LK 8

The shaded area indicates the default setting.

### Programming Procedures

- 1 Go off-line.
- 2 Press LK4 +   to access the Memory Block.
- 3 Press the corresponding CO/PBX line key to change language option.
- 4 Press  to write the data.
- 5 Press  to go back on-line.

### Related Programming

M.B. Number	Memory Block Name
4-01	CO/PBX Ring Assignment (Day Mode)
4-02	CO/PBX Ring Assignment (Night Mode)

## N

1. Telephone ports A0~C0 are ports 100~120.
2. Setting to YES - the telephone will ring for all Ring Assigned Lines set in Memory Blocks , 4-01 and , 4-02.
3. Setting to NO - the telephone will not ring for any Ring Assigned Lines however the Message Waiting Lamp and Answer Key will flash. When NO is selected neither Caller ID nor Trunk Name Assignment will be displayed.

# CO Ringing Pattern Selection for Telephone Mode

Use this Memory Block to assign the ring pattern of telephones for CO/PBX calls.

## Display

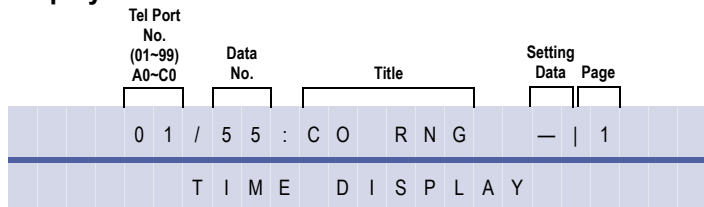

System Mode  
**4**

Submode  
—

Data No.  
**55**

PC Programming  
 + BTT

## Settings

### Page 1

LK 1	LK 2	LK 3	LK 4
—	A	B	C
LK 5	LK 6	LK 7	LK 8
D	E	F	G

### Page 2

LK 9	LK 10	LK 11	LK 12
H			
LK 13	LK 14	LK 15	LK 16

The shaded area indicates the default setting.

## Programming Procedures

1	Go off-line.	
2	Press LK4 +   to access the Memory Block.	
3	Press corresponding CO/PBX line key to change setting data 1. <b>Note:</b> Use the following to enter data: to move the cursor left to move the cursor right ~  to enter setting data 2 to move to the next Tel Port No For example, to assign Trunk Group 5 to CO/PBX line key 1, press LK7 to display TKGP, and enter 05 (for RT 05) using the dial pad.	<b>Default Values:</b> — = NONE
4	Press  to write the data and display the next line key.	
5	Repeat example and step 4 until all line key assignments are complete, and press  to enter last data.	
6	Press  to go back on-line.	

## Related Programming

M.B. Number	Memory Block Name
3-70	CO Line Ringing Pattern Selection for CO/PBX Line Mode
4-56	CO Line Ringing Pattern by Telephone or CO Selection

# N

This memory block is controlled by MB 4-57 if calls are to be CO or Telephone ring.

The Ring Patterns are shown in the table below:

**s = seconds**

Pattern	0s	1s	2s	3s	4s	5s	6s
<b>A</b>							
<b>B</b>							
<b>C</b>							
<b>D</b>							
<b>E</b>							
<b>F</b>							
<b>G</b>							
<b>H</b>							
<b>NIL</b>	No Ring						

# SMDR Telephone Print Selection

## General Description

Use this memory block to enable/disable (per station) SMDR print-out after finishing CO/PBX call.

## Display

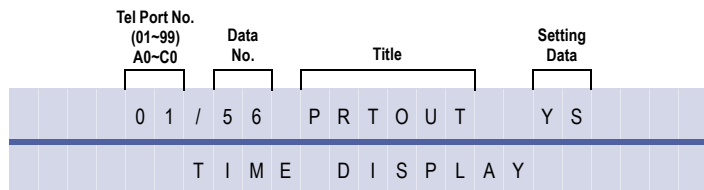

System Mode  
**4**

Submode  
**—**

Data No.  
**56**

PC Programming  
 + AS

## Settings

LK 1	LK 2	LK 3	LK 4
Ys	No		
LK 5	LK 6	LK 7	LK 8

The shaded area indicates the default setting.

## Programming Procedures

- 1 Go off-line.
- 2 Press LK4 + to access the Memory Block.
- 3 Press the corresponding CO/PBX line key to change data option.
- 4 Press to write the data.
- 5 Press to go back on-line.

## Related Programming

M.B. Number	Memory Block Name
1-5-13	Printer Connected Selection
1-5-23	Outgoing Mode Selection

# CO Line Ringing Pattern by Telephone or CO Selection

## General Description

Use this memory block to select if CO or Telephone is to have ring pattern.

## Display

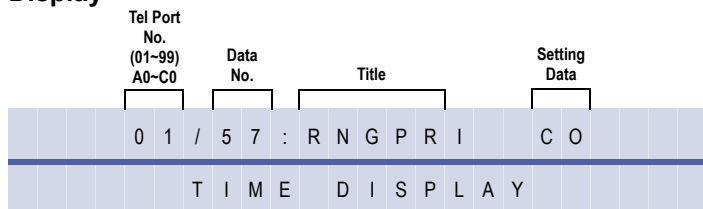

System Mode  
**4**  
 Submode  
 —  
 Data No.  
**57**  
 PC Programming  
 + BTT

## Settings

LK 1	LK 2	LK 3	LK 4
CO	Telephone		
LK 5	LK 6	LK 7	LK 8

The shaded area indicates the default setting.

## Programming Procedures

- 1 Go off-line.
- 2 Press LK4 + to access the Memory Block.
- 3 Press the corresponding CO/PBX line key to change data option  
**Note:** Use the following to change option:  
 to move to the next Tel Port No. **Default Values:**  
CO
- 4 Press to write the data.
- 5 Press to go back on-line.

## Related Programming

M.B. Number	Memory Block Name
<b>3-70</b>	CO Line Ringing Pattern Selection for CO/PBX Line Mode
<b>4-55</b>	CO Ringing Pattern Selection for Telephone Mode

# Automated Attendant DID Assignment

System Mode  
**4**

Submode  
**—**

Data No.  
**58**

PC Programming  
 + AU

## General Description

Use this Memory Block to determine the action after a DID call arrives at an extension or CAR, and is not answered after predetermined time.

## Display

Tel Port No. (01-99) A0-C0	Data No.	Title	Setting Data	Page No.
0 1 /	5 8 :	D I D	N O N /	1
T I M E D I S P L A Y				

## Settings









LK 1	LK 2	LK 3	LK 4
NON	AA1	AA2	AA3
LK 5	LK 6	LK 7	LK 8
AA4	AA5	AA6	AA7

The shaded area indicates the default setting.

### Page 2

LK 9	LK 10	LK 11	LK 12
AA8			
LK 13	LK 14	LK 15	LK 16

## Programming Procedures

<b>1</b>	Go off-line.	
<b>2</b>	Press LK4 +   to access the Memory Block.	
<b>3</b>	Press corresponding CO/PBX line key to change setting data 1. <b>Note:</b> Use the following to enter data:  to move the cursor left  to move the cursor right  to move to the next Tel Port No For example, to assign AA6, press LK7 to display.	<b>Default Values</b> NON
<b>4</b>	Press  to write the data and display the next line key.	
<b>5</b>	Repeat example and step 4 until all line key assignments are complete, and press  to enter last data.	
<b>6</b>	Press  to go back on-line.	

## Related Programming

M.B. Number	Memory Block Name
<b>1-4-02</b>	Automated Attendant Transfer Delayed Ringing Time Selection



# APR Hookflash Selection

## General Description

Use this Memory Block to allow/deny Hookflash for an Analogue Port Adapter (APR) on a Multiline Terminal.

## Display

Tel Port No. (01~CO)	Data No.	Title	Setting Data
01	59	HK FLSH	NO
T I M E D I S P L A Y			

## Settings

LK 1	LK 2	LK 3	LK 4
NO	YS		
LK 5	LK 6	LK 7	LK 8

The shaded area indicates the default setting.

## Programming Procedures

- 1 Go off-line.
- 2 Press LK4 + to access the Memory Block.
- 3 Use the following to enter data:
  - to move the cursor left
  - to move the cursor right
  - ~ to enter numeric data or Tel Port No.
  - OR -
  - to go to next assigned Tel Port No.
  - +1 to enter A for Port Numbers 100~109
  - +2 to enter B for Port Numbers 110~119
  - +3 to enter C for Port Number 120
- 4 Press the corresponding CO/PBX line key to change the setting data option.
- 5 Press to write the data and display Memory Block 4-1 for next Tel Port No.
- 6 Program the next Tel Port No. or press To go back on-line.

## Related Programming

M.B. Number	Memory Block Name
1-1-02	Hookflash Time Selection
1-3-02	SLT Hookflash Signal Selection
4-40	APR Ring Mode Assignment
4-93	DTMF/DP SLT Type Selection

System Mode  
**4**

Submode  
—

Data No.  
**59**

PC Programming

+ BTM



Operation of SLT connected to APR is the same as the Single Line Telephone.

# Station Name/Number Display Selection

## General Description

Use this Memory Block to specify whether the station name and/or station number shall be displayed on an idle Multiline telephone's LCD.

## Display

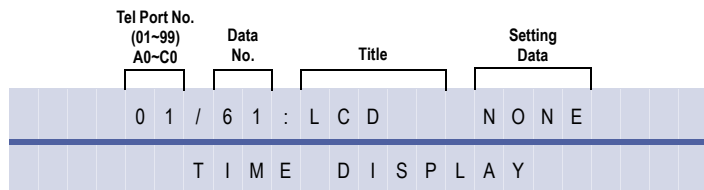

System Mode  
**4**

Submode  
—

**61**

PC Programming  
 + BTT

## Settings

LK 1	LK 2	LK 3	LK 4
NONE	ICM	NAME	BOTH
LK 5	LK 6	LK 7	LK 8

The shaded area indicates the default setting.

## Programming Procedures

- 1 Go off-line.
- 2 Press LK4 + to access the Memory Block.
- 3 Press the corresponding CO/PBX line key to change language option.
- 4 Press to write the data.
- 5 Press to go back on-line.

## Related Programming

M.B. Number	Memory Block Name
4-10	Station Number Assignment
4-18	Station Name Assignment



1. Telephone ports A0~C0 are ports 100~120.
2. Press + 1, 2, 3 = A, B, C for Port Number.

# ISDN Extension-based Caller ID Assignment

## General Description

This Memory Block provides the station DID Number (CPN, Calling Party Number) to the Network when placing outgoing calls.

## Display

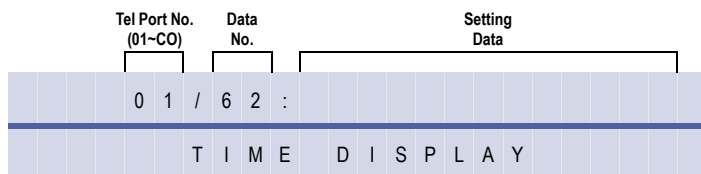

System Mode  
**4**  
 Submode  
 —  
 Data No.  
**62**  
 PC Programming  
 + BTT

## Programming Procedures

<b>1</b>	Go off-line.	
<b>2</b>	Press LK4 +   to access the Memory Block.	
<b>3</b>	Use the following to enter data: to move the cursor left. to move the cursor right. to enter numeric data. <b>- OR -</b> Press  to go to the next TEL port number. Press  to clear data.	<b>Setting Data:</b> Telephone number to be programmed must include area code, minus leading 0. e.g.: 3 X X X X - X X X X
<b>4</b>	Press  to write the data and display Memory Block , 4-01.	
<b>5</b>	Program Memory Block , 4-01 or press  to go back on-line.	

## Related Programming

M.B. Number	Memory Block Name
<b>3-53</b>	ISDN Trunk Directory Number Assignment
<b>3-91</b>	Trunk Type Selection
<b>4-47</b>	ISDN Directory Number Selection

## N

1. A maximum of 13 digits is allowed.
2. Hyphens/dashes are not allowed when entering the directory number.
3. This Memory Block supports only trunks assigned as DID in Memory Block , 3-91.
4. When using CO Line Mode, Memory Block , 3-53 is used to assign the directory number of ISDN.
5. Only numbers within the indial range are valid.

# Timer Class Assignment for Telephone Mode Selection

Submode  
**4**

System Mode  
—

Data No.  
**64**

PC Programming  
 + BTT



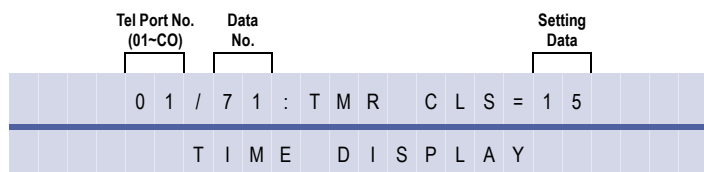

## General Description

This Memory Block assigns class of flexible timer to Extensions. Applicable to IPK R2000.

## Display



## Programming Procedures

<b>1</b>	Go off-line.	
<b>2</b>	Press LK4 +   to access the Memory Block.	
<b>3</b>	Use the following to enter data: * to move the cursor left. # to move the cursor right. 0 ~ 9 to enter numeric data. Setting Data (Allow): 1 (Class 1) to 4 (Class 4) — OR — Press  to go to the next TEL port number.	<b>Default</b> Class 1
<b>4</b>	Press  to write the data and display Memory Block , 4-01.	
<b>5</b>	Program Memory Block, 4-01 or press  to go back on-line.	

## Related Programming

M.B. Number	Memory Block Name
1-1-03	Hold Recall Timer Selection (Non-Exclusive Hold)
1-1-05	Start Timer Selection
1-1-06	CO/PBX Incoming Ringing Alarm Time Selection
1-1-07	Tie/DID Line Delay Ringing Timer Selection
1-1-12	Station Transfer/Camp-On Recall Timer Selection
1-1-37	Trunk Queuing Timeout Selection
1-1-63	Hold Recall Time Selection (Exclusive)
1-1-81	ISDN Dial Interval Timer
1-2-00	Internal Paging Timeout Selection

**Related Programming (Continued)**

<b>1-2-02</b>	Automatic Callback Release Timer Selection
<b>1-2-22</b>	Call Forward No Answer Timer Selection
<b>1-2-23</b>	System Call Park Recall Time Selection
<b>1-3-03</b>	First Digit PBR Release Timer Selection
<b>1-4-01</b>	Automated Attendant First Digit PBR Release Timer Selection
<b>1-4-02</b>	Automated Attendant Transfer Delayed Ringing Time Selection
<b>1-4-03</b>	Automated Attendant No Answer Disconnect Time Selection
<b>1-7-01</b>	Door Phone Display Time Selection
<b>1-7-06</b>	External Paging Timeout Selection
<b>3-61</b>	DIT/ANA Delay Answer Timer Selection

**N**

Telephone Ports A0~C0 are ports 100~120.

# Code Restriction Class Assignment CFVA Restricted Tel/Night Mode

Submode  
**4**

System Mode  
—

Data No.  
**65**

PC Programming  
 + AC







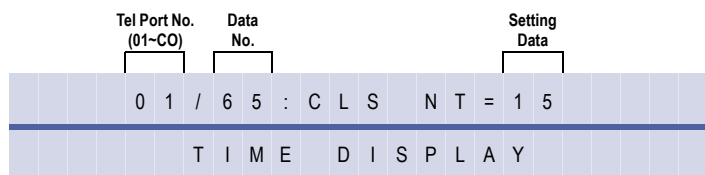

### General Description

This Memory Block assigns class table for dialling restriction when using Trunk Route or Route Advance access code.

### Display



### Programming Procedures

1	Go off-line.
2	Press LK4 +   to access the Memory Block.
3	Use the following to enter data: <ul style="list-style-type: none"> <li> to move the cursor left.</li> <li> to move the cursor right.</li> <li> ~  to enter numeric data.</li> </ul> Setting Data (Allow): 00 (Class 0) to 15 (Class 15)  — OR — Press  to go to the next TEL port number.
4	Press  to write the data and display Memory Block , 4-01.
5	Program Memory Block , 4-01 or press  to go back on-line.

### Related Programming

M.B. Number	Memory Block Name
4-64	Timer Class Assignment for Telephone Mode Selection
1-1-60	8-Digit Matching Table Assignment
1-1-61	8-Digit Matching Table to Class Assignment



Telephone Ports A0~C0 are ports 100~120.

# ACD Plus Hold Tone Selection

## General Description

Use this Memory Block to select the Hold Tone for ACD Plus.

## Display

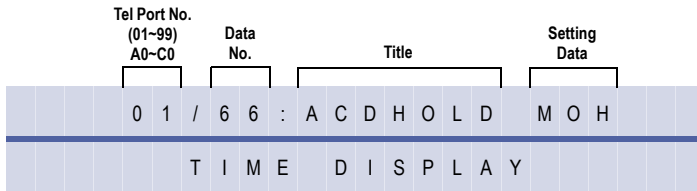

Submode  
**4**

System Mode  
—

Data No.  
**66**

PC Programming  
 +

## Settings

LK 1	LK 2	LK 3	LK 4
MOH	RBT		
LK 5	LK 6	LK 7	LK 8

The shaded area indicates the default setting.

## Programming Procedures

- 1 Go off-line.
- 2 Press LK4 + to access the Memory Block.
- 3 Press the corresponding CO/PBX line key to change data option.  
Use the following to change option:  
 select next Tel Port No.
- 4 Press to write the data.
- 5 Press to go back on-line.

## Related Programming

M.B. Number	Memory Block Name
<b>1-12-00</b>	ACD/UCD Group Pilot Number Assignment
<b>1-8-25</b>	ACD/UCD Group Agent Assignment

**N**

RBT setting is also applicable to callers transferred using the TRANSFER key, providing Ringback tone instead of Music on Hold.

# IP Station Number Assignment

*System Mode*  
**4**  
*Submode*  
**—**  
*Data No.*  
**67**  
*PC Programming*  
 + BTT







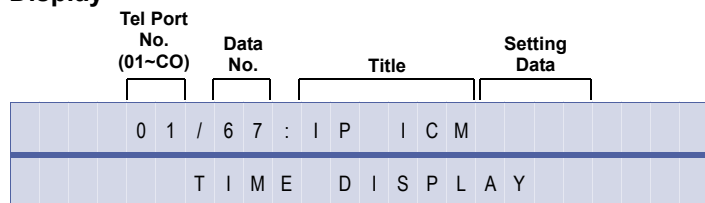







## General Description

Use this Memory Block to assign a station number for each IP telephone supported by the IPCA( )-U( ) ETU.

## Display



## Programming Procedures

- 1 Go off-line.
- 2 Press LK4 +   to access the Memory Block.
- 3 **Note:** Use dial pad to assign a 2- (00~99), 3- (000~999) or 4-digit (0000~9999) station number for each Tel Port No.:
  -  to move the cursor left
  -  to move the cursor right
  -  ~  to enter numeric data or Tel Port No.
  - OR —**
  -  to go to next assigned Tel Port No.
  -  +  to enter A for Port Numbers 100~109.
  -  +  to enter B for Port Numbers 110~119.
  -  +  to enter C for Port Number 120.
- 4 Press  to write the data and display the next Memory Block.
- 5 Program the next Memory Block or press  to go back on-line.

## Related Programming

M.B. Number	Memory Block Name
1-1-46	Access Code (1-Digit) Assignment
1-1-47	Access Code (2-Digit) Assignment
1-2-03	2-, 3-, or 4-Digit Station Number Selection
4-10	Station Number Assignment



Telephone Ports A0~C0 are ports 100~120.



# LCD Line Key – Name Assignment

## General Description

Use this Memory Block to assign a name to each LCD Line Key of the DTR-16LD-1 Telephone. Up to eight characters can be assigned.

## Display

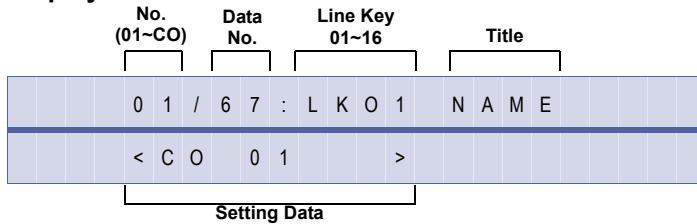

System Mode  
**4**  
Submode  
—  
Data No.  
**68**  
PC Programming  
 + BTT

## Programming Procedures

<b>1</b>	Go off-line.
<b>2</b>	Press LK4 +   to access the Memory Block.
<b>3</b>	<p><b>Note:</b> Use dial pad to change Line Key number or name. <span style="float: right;"><b>Default Value:</b> LK01~08: CO 01~08</span></p> <ul style="list-style-type: none"> <li> to move the cursor left</li> <li> to move the cursor right</li> <li> to enter numeric data or Tel Port No.</li> <li><b>– OR –</b></li> <li> to go to next assigned Tel Port No.</li> <li> +  to enter A for Port Numbers 100~109.</li> <li> +  to enter B for Port Numbers 110~119.</li> <li> +  to enter C for Port Number 120.</li> </ul>
<b>4</b>	Press  to write the data and display the next Line Key and Name.
<b>5</b>	Repeat Steps 3 and 4 for each Line Key assignment. After Line key 16 is programmed, the next Tel Port No. is displayed. When you want to program less than 16 keys, after the last Line key to program, press  to go to next assigned Tel Port No. After all Tel Ports are assigned, the next Memory Block is displayed.
<b>6</b>	Program the next Memory Block or press  to go back on-line.

## Related Programming

M.B. Number	Memory Block Name
<b>7-2</b>	Telephone Type Assignment
<b>4-12</b>	Line Key Selection for Telephone Mode

# N

1. Telephone Ports A0~C0 are ports 100~120.
2. The name can be entered using the dial pad. Follow the procedures in Appendix B Character Codes.
3. The default names listed in the table below are assigned based on the line key type from Memory Block 4-12 (Line Key Selection for Telephone Mode)

LK Assign	Default	Note
NON (not assigned)	All Blank	
CO Outside Lines	CO^xx	xx=Port 01~64
Call Forward – Busy/No Answer	CFB	
Call Forward – All Calls	CFA	
Call Appearance Keys (CAP)	CAPxx-yy	xx=Block 00~47 yy=Key 01~24
Programmable One-Touch Keys	FA xx	xx=key 01~24
Trunk Group	TKGP^xx	xx=Trunk Group 01~32
Route Advance Group	ADV^xx	xx=Group 01~16
SIE including CAR	SIE^xxx	xxx=Port No. 01~99, AO~CO
Microphone	MIC	
Headset On/Off Key	HSET	
Scroll Key for Caller ID indication	SCROLL	
Do Not Disturb On/Off	DND	
Log On/Off	LOG	
BGM On/Off	BGM	
Intercom Key	ICM	

# SLT Data Line Security Assignment

## General Description

Use this Memory Block to specify Normal/Data position for Single Line Telephones (SLTs).

## Display





Tel Port No. (01~99) A0~C0	Data No.	Title	Setting Data
0 1 / 9 0	:	S L T	N O R M A L
T I M E D I S P L A Y			

## Settings

LK 1	LK 2	LK 3	LK 4
SLT Normal	SLT Data		
LK 5	LK 6	LK 7	LK 8

The shaded area indicates the default setting.

## Programming Procedures

1	Go off-line.
2	Press LK4 +   to access the Memory Block.
3	Press the corresponding CO/PBX line key to change data option. Use the following to change option:  select next Tel Port No.
4	Press  to write the data.
5	Press  to go back on-line.

## Related Programming

No related programming is necessary for this Memory Block.

System Mode  
**4**

Submode  
—

Data No.  
**90**

PC Programming  
 + BTT

# N

- When connecting SLT/voice mail, assign SLT Normal. When connecting Fax/Modem, assign SLT Data.
- If Multiline Terminal is assigned for Data Line Security, Tone Override and Call Alert Notification tones are not heard from the handset; however, the tone is still sent and heard from the speaker when off-hook.
- Data Line Security denies a station from barging in, even if Barge-In is allowed in Class of Service.
- If this Memory Block is set to SLT Data, the Voice Override tone is not heard when doing a Voice Over Split.
- Telephone ports A0~C0 are ports 100~120.

# Telephone Ringing Variation Selection

System Mode  
**4**

Submode  
**—**

Data No.  
**91**

PC Programming  
**Alt + BTM**

## General Description

Use this Memory Block to assign a Low, Medium, or High ringing tone frequency if Telephone is specified in Memory Block, 1-1-28 , Distinctive Ringing by Telephone or CO Selection.

## Display

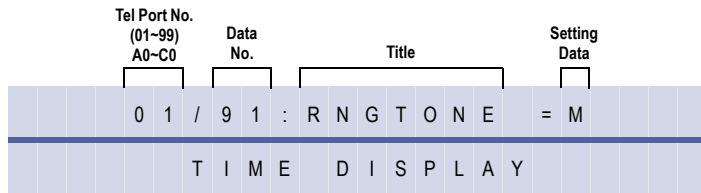

## Settings

LK 1	LK 2	LK 3	LK 4
Medium	Low	High	
LK 5	LK 6	LK 7	LK 8

The shaded area indicates the default setting.

## Programming Procedures

- 1 Go off-line.
- 2 Press LK4 + to access the Memory Block.
- 3 Press the corresponding CO/PBX line key to change data option.  
Use the following to change option:  
 select next Tel Port No.
- 4 Press to write the data.
- 5 Press to go back on-line.

## Related Programming

M.B. Number	Memory Block Name
1-1-28	Distinctive Ringing by Telephone or CO Selection



1. This block is applicable for telephones selected in Memory Block , 1-1-28 , Distinctive Ringing by Telephone or CO Selection.
2. Selected ringing tone (H, M or L) follows when transferring calls.
3. Telephone ports A0~C0 are ports 100~120.

# Receiving Volume Selection

## General Description

Use this Memory Block to specify whether receiving volume is returned to normal (DOWN) or kept as is (UP) on a call after hanging up.

## Display

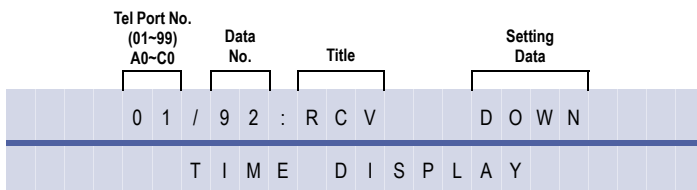

System Mode  
**4**

Submode  
—

Data No.  
**92**

PC Programming  
 + BTM

## Settings

LK 1	LK 2	LK 3	LK 4
Down	Up		
LK 5	LK 6	LK 7	LK 8

The shaded area indicates the default setting.

## Programming Procedures

- 1 Go off-line.
- 2 Press LK4 + to access the Memory Block.
- 3 Press the corresponding CO/PBX line key to change data option.  
Use the following to change option:  
 select next Tel Port No.
- 4 Press to write the data.
- 5 Press to go back on-line.

## Related Programming

M.B. Number	Memory Block Name
1-1-28	Distinctive Ringing by Telephone or CO Selection

# N

1. Receiving Volume Down:  
Multiline Terminal: The volume (increased by + 2) is reset when you hang up.  
Single Line Telephone: Normal.
2. Receiving Volume Up:  
Multiline Terminal: The volume (increased by + 2) is not reset when you hang up.  
Single Line Telephone: The volume is increased 6 dB.
3. This feature applies to internal and external calls.
4. Telephone ports A0~C0 are ports 100~120.

# Internal Zone Paging Selection

## General Description

Use this Memory Block to place stations in Internal page zones.

## Display

Tel Port No. (01-99) A0-C0	Data No.	Title	Setting Data
0 1 / 9 3	:	Z O N E	N O
T I M E D I S P L A Y			

*System Mode*  
**4**

*Submode*  
**—**

*Data No.*  
**93**





*PC Programming*  

## Settings

LK 1	LK 2	LK 3	LK 4
No	Zone A	Zone B	Zone C
LK 5	LK 6	LK 7	LK 8

The shaded area indicates the default setting.

## Programming Procedures

- 1 Go off-line.
- 2 Press LK4 +   to access the Memory Block.
- 3 Press the corresponding CO/PBX line key to change data option.  
**Note:** Use the following to change option:  
 select next Tel Port No.
- 4 Press  to write the data.
- 5 Press  to go back on-line.

## Related Programming

No related programming is necessary for this Memory Block.

# N

1. Specify one zone:  
 All Internal Zones: Paged by dialling 51  
 Zone A: Paged by dialling 52  
 Zone B: Paged by dialling 53  
 Zone C: Paged by dialling 54.
2. Telephones can be assigned to NO Zone. All Internal Zones page the telephone unless No Page Receive is assigned in Memory Block , 4-31 , Receiving Internal/All Call Page Selection.
3. All Internal Zones pages all of the idle Multiline Terminals.
4. Telephone ports A0~C0 are ports 100~120.

# 3-Minute Alarm Selection

## General Description

Use this Memory Block to specify, per station, whether or not a warning signal tone is generated at 3-minute intervals during an outgoing or incoming CO/PBX call.

## Display

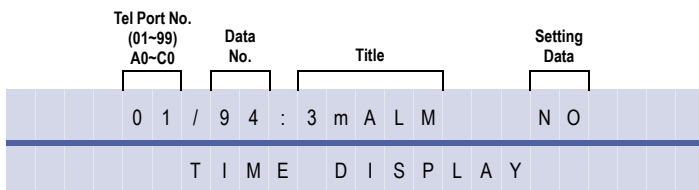

System Mode  
**4**

Submode  
—

Data No.  
**94**





PC Programming  
 + BTI

## Settings

LK 1	LK 2	LK 3	LK 4
No	Yes		
LK 5	LK 6	LK 7	LK 8

The shaded area indicates the default setting.

## Programming Procedures

1	Go off-line.
2	Press LK4 +   to access the Memory Block.
3	Press the corresponding CO/PBX line key to change data option. <b>Note:</b> Use the following to change option:  select next Tel Port No.
4	Press  to write the data.
5	Press  to go back on-line.

## Related Programming

No related programming is necessary for this Memory Block.

## N

1. A 1-second (approximately) warning signal sounds every 3 minutes during CO/PBX calls.
2. The alarm tone is heard through the terminal speaker only.
3. If the built-in speakerphone is used for Handsfree, the warning signal is not used.
4. Telephone ports A0~C0 are ports 100~120.

# DTMF/DP SLT Type Selection

*System Mode*  
**4**

*Submode*  
**—**

*Data No.*  
**95**

*PC Programming*  
 + BTI

## General Description

Use this Memory Block to specify, per port, whether Dial Pulse or Dual-Tone Multifrequency Single Line Telephone is connected to the system.

## Display

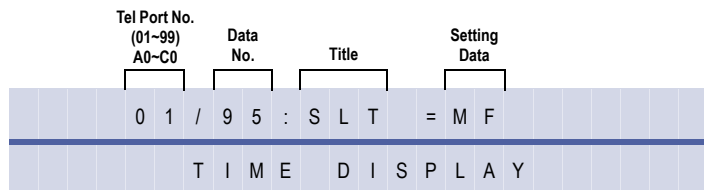





## Settings

LK 1	LK 2	LK 3	LK 4
DP	DTMF (MF)		
LK 5	LK 6	LK 7	LK 8

The shaded area indicates the default setting.

## Programming Procedures

- 1 Go off-line.
- 2 Press LK4 +   to access the Memory Block.
- 3 Press the corresponding CO/PBX line key to change data option.  
**Note:** Use the following to change option:  
 to select next Tel Port No.
- 4 Press  to write the data.
- 5 Press  to go back on-line.

## Related Programming

No related programming is necessary for this Memory Block.



1. The DP selection supports 10 pps or 20 pps.
2. Telephone ports A0~C0 are ports 100~120.





# Digit Add/Del for Tie Line Networking

## General Description



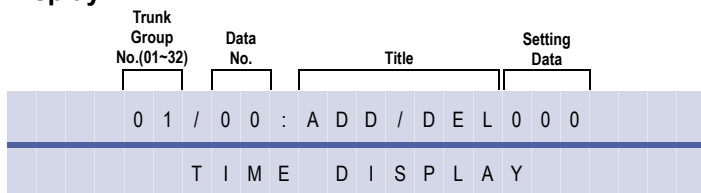







Use this Memory Block to specify the number of digits to be added to and/or deleted from the telephone number sent from a distant system over Tie lines or from DID lines. The digits enable the system to determine whether a call is directed to itself (local) or to another system (distant). Refer to the Notes.

## Display



*System Mode*  
**5**  
*Submode*  
**—**  
*Data No.*  
**00**  
*PC Programming*  
 + ALN

## Programming Procedures

<b>1</b>	Go off-line.
<b>2</b>	Press LK5 +  +   to access the Memory Block.
<b>3</b>	<p>Press the corresponding CO/PBX line key to enter the data.</p> <p><b>Note:</b> Use the following to enter data:</p> <ul style="list-style-type: none"> <li> to move the cursor left</li> <li> to move the cursor right</li> <li> ~  to enter numeric data</li> <li> to go to the next Trunk Group No.</li> </ul> <p><b>Setting Data:</b></p> <ul style="list-style-type: none"> <li>000 : No Addition or Deletion</li> <li>001~009 : [1]~[9] Addition</li> <li>010 : [0] Digit Addition</li> <li>100~199 : [00]~[99] Addition</li> <li>201 : 1 Digit Deletion</li> <li>202 : 2 Digit Deletion</li> <li>301~309 : 1 digit Delete and 1~9 Add</li> <li>310 : 1 digit Delete and 0 Add</li> <li>400~499 : 1 digit Delete and 00~99 Add</li> <li>501~509 : 2 digit Delete and 1 ~ 9 Add</li> <li>510 : 2 digit Delete and 0 Add</li> <li>600~699 : 2 digit Delete and 00 ~99 Add</li> </ul>
<b>4</b>	After entering all data for all pages, press  to write the data.
<b>5</b>	Press  to go back on-line.

Doc. No.: 8194 - Release 2.0  
 December 2004

**Related Programming**

M.B. Number	Memory Block Name
1-1-46	Access Code (1-Digit) Assignment
3-03	Trunk-to-Trunk Group Assignment

**N**

1. This Memory Block applies only when two or more systems are connected by Tie lines or when the systems are connected by a DID line.
2. If the call is intended for another system, the Tie line is directed to resend the number.
3. At default, DID lines are not assigned to a Trunk Group.
4. This Memory Block affects PRT/BRT channels assigned as Tie/DID lines.

# Tie Line Networking Tandem Connection Assignment

## General Description

Use this Memory Block to specify whether or not Trunk Groups connected to the system allow incoming Trunk Groups to be connected to outgoing Trunk Groups for tandem connections.

## Display

(Incoming) Trunk Group No. (01~32)	Data No.	Title	Setting Data
01	/ 01	T A N D E M	01
T I M E D I S P L A Y			

System Mode  
**5**  
Submode  
—  
Data No.  
**01**  
PC Programming  
 + ALN

## Settings

### (Page 1)

LK 1	LK 2	LK 3	LK 4
01	02	03	04
LK 5	LK 6	LK 7	LK 8
05	06	07	08

### (Page 2)

LK 1	LK 2	LK 3	LK 4
09	10	11	12
LK 5	LK 6	LK 7	LK 8
13	14	15	16

### (Page 3)











LK 1	LK 2	LK 3	LK 4
17	18	19	20
LK 5	LK 6	LK 7	LK 8
21	22	23	24

There is no default setting.

### (Page 4)

LK 1	LK 2	LK 3	LK 4
25	26	27	28
LK 5	LK 6	LK 7	LK 8
29	30	31	32

**Programming Procedures**

<b>1</b>	Go off-line.						
<b>2</b>	Press LK5 +  +   to access the Memory Block.						
<b>3</b>	<p>Press the corresponding CO/PBX line key to change the data option. Operation data includes:</p> <table border="1" style="margin-left: 20px;"> <tr> <td style="text-align: center;">CO/PBX Line LED</td> <td style="text-align: center;">Off</td> <td style="text-align: center;">On</td> </tr> <tr> <td style="text-align: center;">Data</td> <td style="text-align: center;">No</td> <td style="text-align: center;">Yes</td> </tr> </table> <p style="margin-left: 20px;">There is no default setting.</p> <p><b>Note:</b> Use the following to enter data:</p> <ul style="list-style-type: none"> <li> to move the cursor left</li> <li> to move the cursor right</li> <li> to go to the next page</li> <li> to go to the previous page</li> <li> to go to the next Trunk Group No.</li> </ul>	CO/PBX Line LED	Off	On	Data	No	Yes
CO/PBX Line LED	Off	On					
Data	No	Yes					
<b>4</b>	Press  to write the data.						
<b>5</b>	Press  to go back on-line.						

**Related Programming**

M.B. Number	Memory Block Name
<b>3-03</b>	Trunk-to-Trunk Group Assignment
<b>4-09</b>	Telephone to Tenant Assignment



Tandem connection of Trunk Group-to-Trunk Group must be specified separately.

# 8-Digit Matching Table to Trunk Group Assignment

## General Description

Use this Memory Block to assign each Trunk Group to the 8-Digit Matching Tables.

## Display

Trunk Group No. (01-32)	Data No.	Title	Page No.
0 1 / 0 2	:	8 D G = T R K G	1
T I M E D I S P L A Y			

System Mode  
**5**  
Submode  
—  
Data No.  
**02**  
PC Programming  
 + AC

## Settings

### (Page 1)



LK 1	LK 2	LK 3	LK 4
Table 00	Table 01	Table 02	Table 03
LK 5	LK 6	LK 7	LK 8
Table 04	Table 05	Table 06	Table 07

### (Page 2)

LK 1	LK 2	LK 3	LK 4
Table 08	Table 09	Table 10	Table 11
LK 5	LK 6	LK 7	LK 8
Table 12	Table 13	Table 14	Table 15







There is no default setting.

## Programming Procedures

- 1 Go off-line.
- 2 Press LK5 +  +   to access the Memory Block.
- 3 Press the corresponding CO/PBX line key to change the data option. Operation data includes:
 

CO/PBX Line LED	Off	On
Data	Disabled	Enabled

The shaded area indicates the default setting.

**Note:** Use the following to enter data:  
 to move the cursor left  
 to move the cursor right  
 to go to the next page  
 to go to the previous page  
 to go to the next Trunk Group No.
- 4 Press  to write the data.
- 5 Press  to go back on-line.

## Related Programming

Refer to Section 6, *Code Restriction* in this chapter.

# OCC Table to Trunk Group Assignment

*System Mode*  
**5**  
*Submode*  
**—**  
*Data No.*  
**03**  
*PC Programming*  
 + AC

## General Description

Use this Memory Block to assign each of the 16 OCC Tables to each Trunk Group.

## Display

Trunk Group No. (01-32)	Data No.	Title	Page No.
01	03	OCC = TRKG	1
T I M E D I S P L A Y			

## Settings

### (Page 1)











LK 1	LK 2	LK 3	LK 4
Table 00	Table 01	Table 02	Table 03
LK 5	LK 6	LK 7	LK 8
Table 04	Table 05	Table 06	Table 07

### (Page 2)

LK 1	LK 2	LK 3	LK 4
Table 08	Table 09	Table 10	Table 11
LK 5	LK 6	LK 7	LK 8
Table 12	Table 13	Table 14	Table 15

There is no default setting.

## Programming Procedures

1	Go off-line.							
2	Press LK5 +  +   to access the Memory Block.							
3	Press the corresponding CO/PBX line key to enter the data. Operation data includes:	<b>Default Values</b> Use all tables						
	<table border="1" style="width: 100%;"> <tr> <td>CO/PBX Line LED</td> <td>Off</td> <td>On</td> </tr> <tr> <td>Data</td> <td>Disabled</td> <td>Enabled</td> </tr> </table> <p><b>Note:</b> Use the following to enter data:</p> <ul style="list-style-type: none"> <li> to moves the cursor left</li> <li> to moves the cursor right</li> <li> to go to the next page</li> <li> to go to the previous page</li> <li> to go to the next Trunk Group No.</li> </ul>	CO/PBX Line LED	Off	On	Data	Disabled	Enabled	
CO/PBX Line LED	Off	On						
Data	Disabled	Enabled						
4	After entering all data for all pages, press  to write the data.							
5	Press  to go back on-line.							

## Related Programming

Refer to *Section 6, Code Restriction* in this chapter.

# LCR Class to Trunk Group Selection

## General Description

Use this Memory Block per trunk group to specify the Least Cost Routing (LCR)/Automatic Carrier Routing (ACR) Class. For systems connected using K-CCIS, the Electra Elite can analyze incoming telephone numbers received from a distant system and use the LCR/ARS assignments to route the call to its desired destination.

Applicable for IPK R2000 and above.

## Display

Trunk Group No. (01-32)	Data No.	Title	Setting Data
01	04	CLASS	0
T I M E D I S P L A Y			

## Settings

LK1	LK2	LK3	LK4	LK5	LK6	LK7	LK8
0	1	2	3	4			

The shaded area indicates the default setting.

## Programming Procedures

1	Go off-line.
2	Press LK5 +  +   to access the Memory Block.
3	Press the corresponding CO/PBX line key to change the Setting Data option.
4	Press  to write the data. The next Memory Block is displayed.
5	Program the next Memory Block or press  to go back on-line.

## Related Programming

M.B. Number	Memory Block Name
3-70	CIC Number Assignment
1-1-05	Start Time Selection
1-1-46-48	Access Code (1-, 2- or 3-Digit) Assignment
1-15-00	K-CCIS Main/Remote Office Selection
1-15-02	Common Signal Channel Assignment
1-15-03	Originating Point Code Assignment
1-15-04	Destination Point Code Assignment
1-15-05	Destination Point Code Transfer Assignment
1-15-06	Originating Office Code Number Assignment
1-15-07	K-CCIS Message Response Timeout Assignment
1-15-08	Link Reconnect Allow/Deny Selection

System Mode  
**5**

Submode  
—

Data No.  
**04**

PC Programming  
 + AW

**Related Programming (Continued)**

M.B. Number	Memory Block Name
1-15-09	K-CCIS Maximum Call Forwarding Hop Assignment
1-15-10	Calling Name Display Allow/Deny Selection
5-05	Common Signalling Channel Route Selection

---

**N**

Refer to the Electra Elite IPK Key-Common Channel Interoffice Signalling (K-CCIS) Manual for details.



# Common Signalling Channel Route Assignment

## General Description

Use this Memory Block to specify the Common Signalling Channel for each voice trunk group used for K-CCIS.

Applicable for IPK R2000 and above.

## Display









Trunk Group No. (01~32)		Data No.	Title				Setting Data			
0 1	/	0 5	:	C	C	H	C	H	:	0
T I M E D I S P L A Y										

## Settings

LK1	LK2	LK3	LK4	LK5	LK6	LK7	LK8
0	1	2	3	4			

The shaded area indicates the default setting.

## Programming Procedures

1	Go off-line.	
2	Press LK5+  +   to access the Memory Block. <b>Note:</b> Use the following to enter data:  to move cursor left  to move cursor right  ~  to enter numeric data	<b>Default Values:</b> 0 (Not Assigned) CCH: 1~4
3	Press  to write the data.	
4	Press  to go back on-line.	

## Related Programming

M.B. Number	Memory Block Name
3-70	CIC Number Assignment
1-1-05	Start Time Selection
1-1-46~48	Access Code (1-, 2- or 3-Digit) Assignment
1-15-00	K-CCIS Main/Remote Office Selection
1-15-02	Common Signal Channel Assignment
1-15-03	Originating Point Code Assignment
1-15-04	Destination Point Code Assignment
1-15-05	Destination Point Code Transfer Assignment
1-15-06	Originating Office Code Number Assignment
1-15-07	K-CCIS Message Response Time Assignment
1-15-08	Link Reconnect Allow/Deny Selection

System Mode  
**5**

Submode  
—

Data No.  
**05**

PC Programming  
 + **AW**

**Related Programming (Continued)**

M.B. Number	Memory Block Name
1-15-09	K-CCIS Maximum Call Forwarding Hop Assignment
1-15-10	Calling Name Display Allow/Deny Selection
5-4	LCR Class to Trunk Group Selection

---

**N**

This Memory Block is used to assign the voice channels to the Common Channel. When the voice channels trunk group is set at 0, K-CCIS does not operate correctly.

# Trunk Group Outgoing Priority Selection

## General Description

Use this Memory Block to assign the Outgoing Priority for trunk access to each Trunk Group. This is normally used with a Tie Line or K-CCIS network to reverse the search order and reduce call collisions during trunk seizure.

Applicable for IPK R2000 and above.

## Display

Trunk Group No. (01~32)	Data No.	Title	Setting Data
01	06	PRIOR.	H > L
T I M E D I S P L A Y			

## Settings

LK1	LK2	LK3	LK4	LK5	LK6	LK7	LK8
H → L High to Low	L → H Low to High	2	3	4			

The shaded area indicates the default setting.

## Programming Procedures

1	Go off-line.
2	Press LK5 +  +   to access the Memory Block.
3	Press the corresponding CO/PBX line key to change the Setting Data option.
4	Press  to write the data. The next Memory Block is displayed.
5	Program the next Memory Block or press  to go back on-line.

## Related Programming

M.B. Number	Memory Block Name
1-1-46~48	Access Code (1-, 2- or 3-Digit) Assignment Function 201~232 – Route Advance Block 01~32 Function 401~416 – Closed Number Block 01~32 Function 601~604 – ACR Table 1~4
1-1-30	Route Advance Block Assignment
1-1-49	Networking Trunk Group/Route Advance Assignment
1-14-04	ACR Trunk Group to Route Number Assignment

N

This Memory Block should not be assigned (use default) for trunk groups with trunks belonging to an IAD(8)-U( ) ETU used with IP (K-CCIS) or IP (K-CCIS) to NEAX (Point-to-Multipoint).

System Mode  
**5**

Submode  
—

Data No.  
**06**

PC Programming  
 + ALN

THIS PAGE INTENTIONALLY LEFT BLANK

# Tenant Mode Copy Assignment

System Mode  
**6**  
 Submode  
**2**  
 Data No.  
 —

## General Description

Use this Memory Block to enable copying data from one tenant to another tenant or multiple consecutive tenants.

## Display

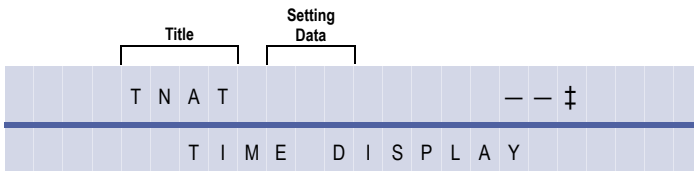

## Programming Procedures

- 1 Go off-line.
- 2 Press LK6 + LK2 to access the Memory Block.
- 3 Enter the tenant to be copied.  
**Note:** Use the following to enter data:  
 ~ to enter numeric data  
 to clear all data when placed at cursor position

## Related Programming

No related programming is necessary for this Memory Block.

**Example:** To copy data of Tenant 00 to Tenant 05~07:

1. Enter the original Tenant No. Using the dial pad, press .

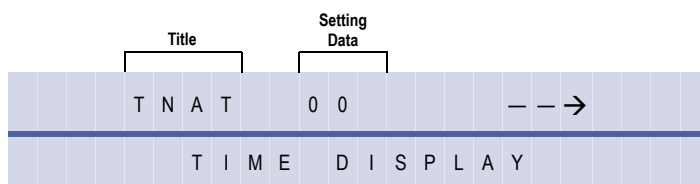

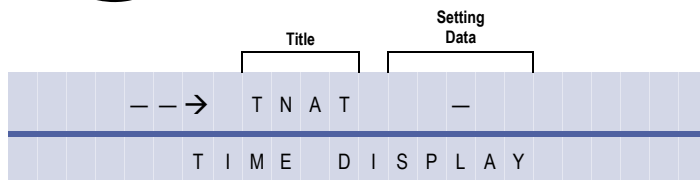

2. Press .

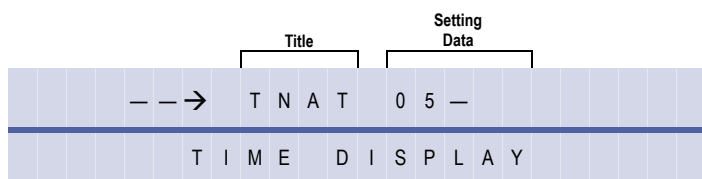

3. Enter the beginning of the tenant (00~47) range to be copied to. Using the dial pad, press  .



4. Enter the end of the tenant (00~47) range to be copied to. Using the dial pad, press  .

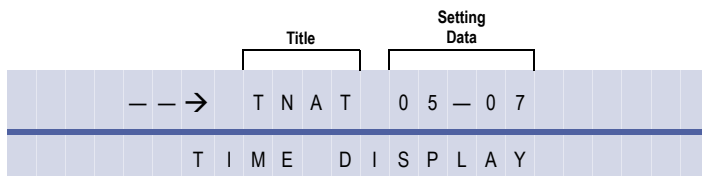

5. Press .

# CO Line Mode Copy Assignment

System Mode  
**6**  
 Submode  
**3**  
 Data No.  
 —



## General Description

Use this Memory Block to enable copying data from one CO/PBX line to another CO/PBX line or multiple consecutive CO/PBX lines.

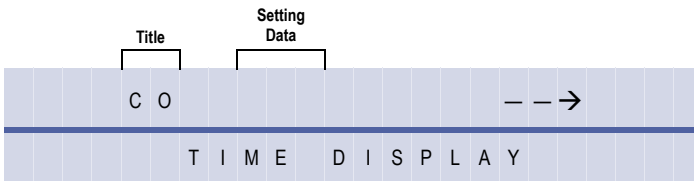
## Display





## Programming Procedures

1	Go off-line.
2	Press LK6 + LK3 to access the Memory Block.
3	Enter the CO/PBX line to be copied. <b>Note:</b> Use the following to enter data:  ~  to enter numeric data  to clear all data when placed at cursor position

## Related Programming

No related programming is necessary for this Memory Block.

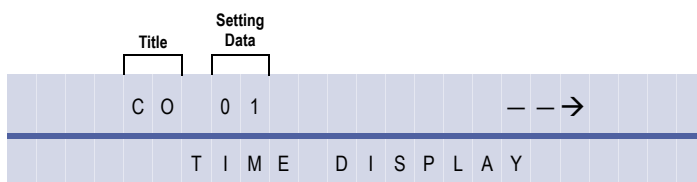

**Example:** To copy data of CO/PBX line 01 to CO/PBX line 05~07:

- Enter the original CO/PBX No. Using the dial pad, press  .



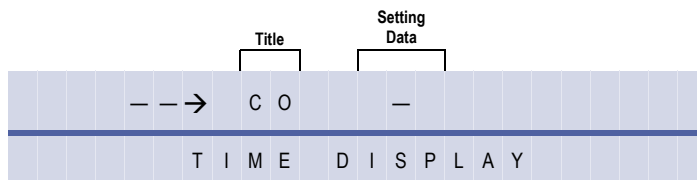

- Press .

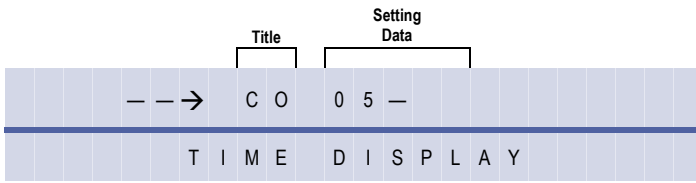

3. Enter the beginning of the CO/PBX (02~64) range to be copied to. Using the dial pad, press  .



4. Enter the end of the CO/PBX (02~64) range to be copied to. Using the dial pad, press  .

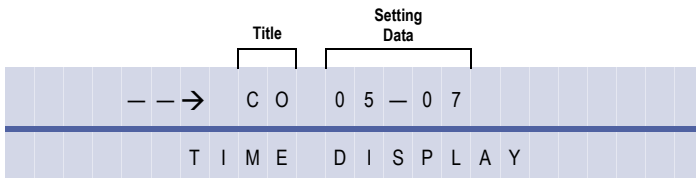

5. Press .



# Telephone Mode Copy Assignment

**6**  
Submode  
**4**  
Data No.  
—

## General Description

Use this Memory Block to enable copying data from one telephone port to another telephone port or multiple consecutive telephone ports.

## Display

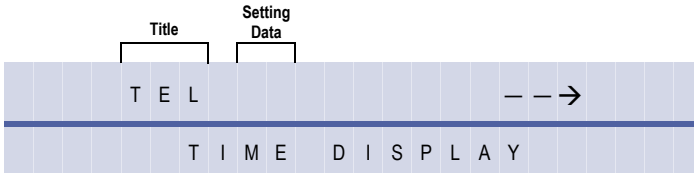

## Programming Procedures

1	Go off-line.
2	Press LK6 + LK4 to access the Memory Block.
3	Enter the Tel. Port No. to be copied. <b>Note:</b> Use the following to enter data: <div style="display: flex; justify-content: space-around; align-items: center;"> <span> ~ </span> <span>to enter numeric data</span> </div> <div style="display: flex; justify-content: space-around; align-items: center; margin-top: 5px;"> <span></span> <span>to clear all data when placed at cursor position</span> </div>

## Related Programming

No related programming is necessary for this Memory Block.

**Example:** To copy data of telephone port 10 to telephone ports 20~30:

1. Enter the original Tel. No. Using the dial pad, press .

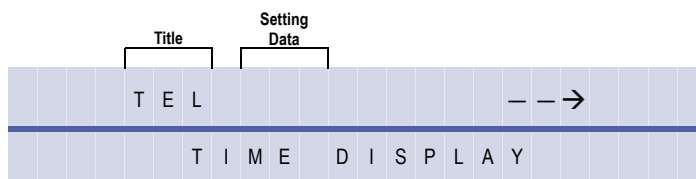

2. Press .

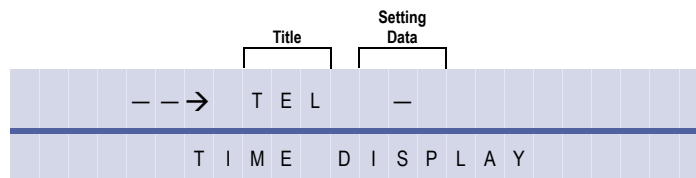

3. Enter the beginning of the Tel. Port No. (01~C0) range to be copied to. Using the dial pad, press  $\text{2}$   $\text{0}$  .

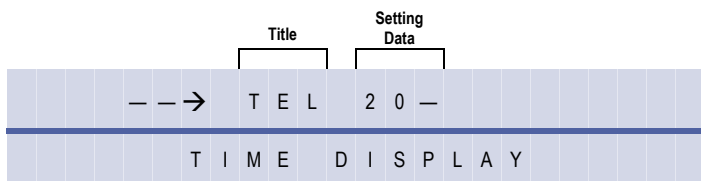

4. Enter the end of the Tel. Port No. (01~C0) range to be copied to. Using the dial pad, press  $\text{3}$   $\text{0}$  .

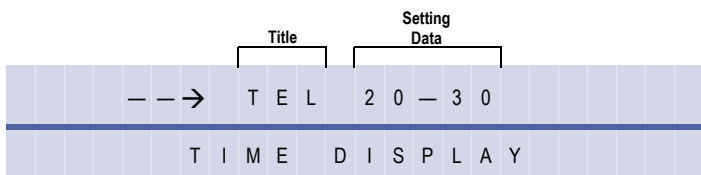

5. Press  $\text{Transfer}$  .

# Trunk Group Mode Copy Assignment

System Mode  
**6**  
 Trunk Group  
**5**  
 Data No.  
 —

## General Description

Use this Memory Block to enable copying data from one Trunk Group to another Trunk Group or multiple consecutive Trunk Groups.

## Display

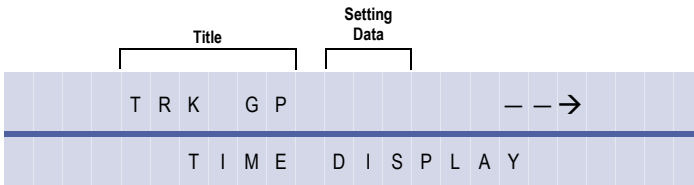

## Programming Procedures

1	Go off-line.
2	Press LK6 + LK5 to access the Memory Block.
3	Enter the Trunk Group to be copied. <b>Note:</b> Use the following to enter data: 0 ~ 9 to enter numeric data Hold to clear all data when placed at cursor position

## Related Programming

No related programming is necessary for this Memory Block.

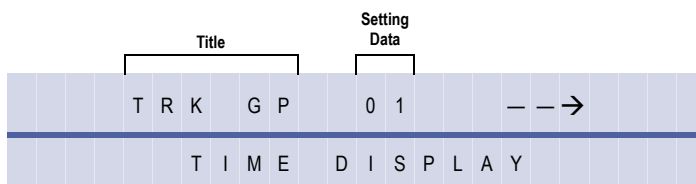

**Example:** To copy data of Trunk Group 01 to Trunk Groups 10~14:

- Enter the original Trunk Group using the dial pad; press **01~32**.



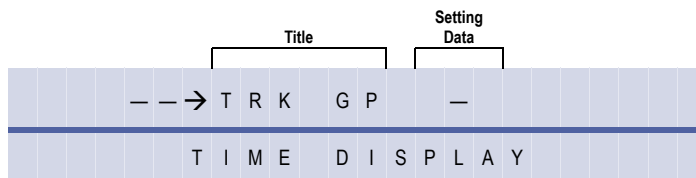

- Press **Transfer**.

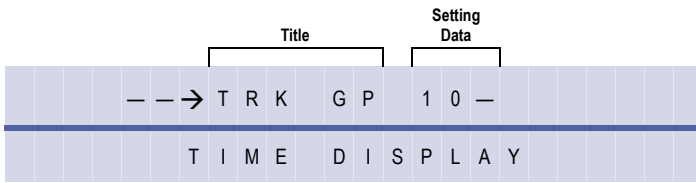

3. Enter the Start Trunk Group No. (01~32). Using the dial pad, press   .



4. Enter the End Trunk Group (01~32). Using the dial pad, press   .

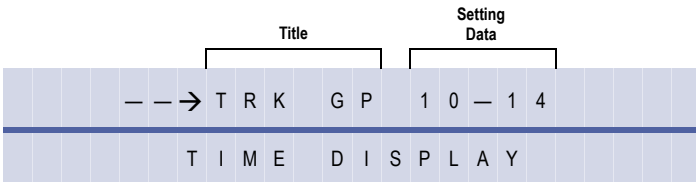

5. Press  .



**Programming Procedures**

<b>1</b>	Go off-line.
<b>2</b>	Press LK7 + LK1 to access the Memory Block.
<b>3</b>	Use the Line key to enter setting data.

<p>Page 1</p> <table border="1" style="width: 100%;"> <thead> <tr> <th style="width: 10%;">Line Key</th> <th style="width: 40%;">Setting Data</th> <th style="width: 50%;">LCD Indication</th> </tr> </thead> <tbody> <tr><td style="text-align: center;">1</td><td style="text-align: center;">NON</td><td></td></tr> <tr><td style="text-align: center;">2</td><td style="text-align: center;">COI(4)-U( )/COIB(4)-U( )</td><td style="text-align: center;">COI 4</td></tr> <tr><td style="text-align: center;">3</td><td style="text-align: center;">COI(8)-U( )/COIB(8)-U( )</td><td style="text-align: center;">COI 8</td></tr> <tr><td style="text-align: center;">4</td><td style="text-align: center;">NON</td><td></td></tr> <tr><td style="text-align: center;">5</td><td style="text-align: center;">COID(4)-U( )/COIB(4)-U( )</td><td style="text-align: center;">COID 4</td></tr> <tr><td style="text-align: center;">6</td><td style="text-align: center;">COID(8)-U( )/COIB(8)-U( )</td><td style="text-align: center;">COID 8</td></tr> <tr><td style="text-align: center;">7</td><td style="text-align: center;">TLI(2)-U( )</td><td style="text-align: center;">TLI</td></tr> <tr><td style="text-align: center;">8</td><td style="text-align: center;">DID(4)-U( )</td><td style="text-align: center;">DID</td></tr> </tbody> </table>	Line Key	Setting Data	LCD Indication	1	NON		2	COI(4)-U( )/COIB(4)-U( )	COI 4	3	COI(8)-U( )/COIB(8)-U( )	COI 8	4	NON		5	COID(4)-U( )/COIB(4)-U( )	COID 4	6	COID(8)-U( )/COIB(8)-U( )	COID 8	7	TLI(2)-U( )	TLI	8	DID(4)-U( )	DID	<p>Page 2</p> <table border="1" style="width: 100%;"> <thead> <tr> <th style="width: 10%;">Line Key</th> <th style="width: 40%;">Setting Data</th> <th style="width: 50%;">LCD Indication</th> </tr> </thead> <tbody> <tr><td style="text-align: center;">1</td><td style="text-align: center;">ESI(8)-U( )</td><td style="text-align: center;">ESI 8</td></tr> <tr><td style="text-align: center;">2</td><td style="text-align: center;">NON</td><td></td></tr> <tr><td style="text-align: center;">3</td><td style="text-align: center;">SLI(8)/CNF(8)-U( )</td><td style="text-align: center;">SLI 8</td></tr> <tr><td style="text-align: center;">4</td><td style="text-align: center;">OPX(2)-U( )</td><td style="text-align: center;">OPX</td></tr> <tr><td style="text-align: center;">5</td><td style="text-align: center;">VDH2(8)-U( ) (Refer to Note 7)</td><td style="text-align: center;">VDH</td></tr> <tr><td style="text-align: center;">6</td><td style="text-align: center;">DPH(4)-U( )</td><td style="text-align: center;">DPH</td></tr> <tr><td style="text-align: center;">7</td><td style="text-align: center;">PBR( )-U( )</td><td style="text-align: center;">PBR</td></tr> <tr><td style="text-align: center;">8</td><td style="text-align: center;">ECR-U( )</td><td style="text-align: center;">ECR</td></tr> </tbody> </table>	Line Key	Setting Data	LCD Indication	1	ESI(8)-U( )	ESI 8	2	NON		3	SLI(8)/CNF(8)-U( )	SLI 8	4	OPX(2)-U( )	OPX	5	VDH2(8)-U( ) (Refer to Note 7)	VDH	6	DPH(4)-U( )	DPH	7	PBR( )-U( )	PBR	8	ECR-U( )	ECR
Line Key	Setting Data	LCD Indication																																																					
1	NON																																																						
2	COI(4)-U( )/COIB(4)-U( )	COI 4																																																					
3	COI(8)-U( )/COIB(8)-U( )	COI 8																																																					
4	NON																																																						
5	COID(4)-U( )/COIB(4)-U( )	COID 4																																																					
6	COID(8)-U( )/COIB(8)-U( )	COID 8																																																					
7	TLI(2)-U( )	TLI																																																					
8	DID(4)-U( )	DID																																																					
Line Key	Setting Data	LCD Indication																																																					
1	ESI(8)-U( )	ESI 8																																																					
2	NON																																																						
3	SLI(8)/CNF(8)-U( )	SLI 8																																																					
4	OPX(2)-U( )	OPX																																																					
5	VDH2(8)-U( ) (Refer to Note 7)	VDH																																																					
6	DPH(4)-U( )	DPH																																																					
7	PBR( )-U( )	PBR																																																					
8	ECR-U( )	ECR																																																					

<p>Page 3</p> <table border="1" style="width: 100%;"> <thead> <tr> <th style="width: 10%;">Line Key</th> <th style="width: 40%;">Setting Data</th> <th style="width: 50%;">LCD Indication</th> </tr> </thead> <tbody> <tr><td style="text-align: center;">1</td><td style="text-align: center;">VRS(4)-U( )</td><td style="text-align: center;">VRS</td></tr> <tr><td style="text-align: center;">2</td><td style="text-align: center;">NON</td><td></td></tr> <tr><td style="text-align: center;">3</td><td style="text-align: center;">VMS(2)/(4)/FMS(2)/(4)-U( )/ CMS(2)/(4)-U( )</td><td style="text-align: center;">VMS 4</td></tr> <tr><td style="text-align: center;">4</td><td style="text-align: center;">CTI/FMS/VMS(8)-U( )</td><td style="text-align: center;">VMS 8</td></tr> <tr><td style="text-align: center;">5</td><td style="text-align: center;">BRT(4)-U( )</td><td style="text-align: center;">BRT</td></tr> <tr><td style="text-align: center;">6</td><td style="text-align: center;">NON</td><td></td></tr> <tr><td style="text-align: center;">7</td><td style="text-align: center;">NON</td><td></td></tr> <tr><td style="text-align: center;">8</td><td style="text-align: center;">MIFM-U( )</td><td style="text-align: center;">MIFM</td></tr> </tbody> </table>	Line Key	Setting Data	LCD Indication	1	VRS(4)-U( )	VRS	2	NON		3	VMS(2)/(4)/FMS(2)/(4)-U( )/ CMS(2)/(4)-U( )	VMS 4	4	CTI/FMS/VMS(8)-U( )	VMS 8	5	BRT(4)-U( )	BRT	6	NON		7	NON		8	MIFM-U( )	MIFM	<p>Page 4</p> <table border="1" style="width: 100%;"> <thead> <tr> <th style="width: 10%;">Line Key</th> <th style="width: 40%;">Setting Data</th> <th style="width: 50%;">LCD Indication</th> </tr> </thead> <tbody> <tr><td style="text-align: center;">1</td><td style="text-align: center;">MIFA-U( )</td><td style="text-align: center;">MIFA</td></tr> <tr><td style="text-align: center;">2</td><td style="text-align: center;">NON</td><td></td></tr> <tr><td style="text-align: center;">3</td><td style="text-align: center;">BSC</td><td></td></tr> <tr><td style="text-align: center;">4</td><td style="text-align: center;">BIO</td><td></td></tr> <tr><td style="text-align: center;">5</td><td style="text-align: center;">NON</td><td></td></tr> <tr><td style="text-align: center;">6</td><td style="text-align: center;">NON</td><td></td></tr> <tr><td style="text-align: center;">7</td><td style="text-align: center;">BSU(2)-U( )</td><td style="text-align: center;">BSU2*</td></tr> <tr><td style="text-align: center;">8</td><td style="text-align: center;">SLI(4)-U( )</td><td style="text-align: center;">SLI4*</td></tr> </tbody> </table>	Line Key	Setting Data	LCD Indication	1	MIFA-U( )	MIFA	2	NON		3	BSC		4	BIO		5	NON		6	NON		7	BSU(2)-U( )	BSU2*	8	SLI(4)-U( )	SLI4*
Line Key	Setting Data	LCD Indication																																																					
1	VRS(4)-U( )	VRS																																																					
2	NON																																																						
3	VMS(2)/(4)/FMS(2)/(4)-U( )/ CMS(2)/(4)-U( )	VMS 4																																																					
4	CTI/FMS/VMS(8)-U( )	VMS 8																																																					
5	BRT(4)-U( )	BRT																																																					
6	NON																																																						
7	NON																																																						
8	MIFM-U( )	MIFM																																																					
Line Key	Setting Data	LCD Indication																																																					
1	MIFA-U( )	MIFA																																																					
2	NON																																																						
3	BSC																																																						
4	BIO																																																						
5	NON																																																						
6	NON																																																						
7	BSU(2)-U( )	BSU2*																																																					
8	SLI(4)-U( )	SLI4*																																																					

**Programming Procedures (Continued)**

**4** Use the Line Key to enter Setting Data.

Page 1

Line Key	Setting Data	LCD Indication
1	ESIB(8)-U( )	ESIB8
2	ESIE(8)-U( )	ESIB16
3	MG(8)-U( )	MG
4	HUB(8)-U( )	HUB
5	NON	
6	NON	
7	NON	
8	NON	

Page 2

Line Key	Setting Data	LCD Indication
1	NON	DT14
2	NON	DT18
3	NON	DTI12
4	NON	DTI16
5	NON	DTI20
6	NON	DTI24
7	NON	
8	NON	

Page 3

Line Key	Setting Data	LCD Indication
1	PRT(1)-U( )	PRT4
2	PRT(1)-U( )	PRT8
3	PRT(1)-U( )	PRT12
4	PRT(1)-U( )	PRT16
5	PRT(1)-U( )	PRT20
6	PRT(1)-U( )	PRT24
7	PRT(1)-U( )	PRT28
8	PRT(1)-U( )	PRT32

**Note:** Use the following to enter data:

- ⌘ to move the cursor left.
- # to move the cursor right.
- 0 ~ 9 to enter numeric data.
- Recall to go to the next page.
- Feature to go to the previous page.

**5** Press **Transfer** to write the data.

**6** Press **Speaker** to go back on-line.

## KSU Power-Based ETU Quantity Limitations

The following charts indicate the maximum number of specific ETU combinations in each KSU that are restricted by power limitations of the KSU.

### For System without Xen VP/CTI

*NO. of ESI(8) ETUs	NO. of ESI Ports	Either EliteMail VP or CTI	Maximum NO. of ACD+/CMS/FMS/VMS/IPT/SLI/OPX/or DID ETUs	Other ETUs
10	80	0	2	No Limitation
9	72	0	2	No Limitation
8	64	0	3	No Limitation
7	56	0	4	No Limitation
6	48	0	5	No Limitation
5	40	0	5	No Limitation
4	32	0	6	No Limitation
3	24	0	6	No Limitation
2	16	0	7	No Limitation
1	8	0	7	No Limitation

### For System with Xen VP/CTI

*NO. of ESI(8) ETUs	NO. of ESI Ports	Either EliteMail VP or CTI	Maximum NO. of ACD+/CMS/FMS/VMS/IPT/SLI/OPX/or DID ETUs	Other ETUs
9	72	1	0	No Limitation
8	64	1	0	No Limitation
7	56	1	1	No Limitation
6	48	1	2	No Limitation
5	40	1	2	No Limitation
4	32	1	3	No Limitation
3	24	1	4	No Limitation
2	16	1	4	No Limitation
1	8	1	5	No Limitation

\* The number of 8-port ESI ETUs installed including ESI(8)-U( ), ESIB(8)-U( ), or ESIE(8)-U( ) ETU.



### Card Interface Slot Assignment

ETU	PORT No. (Refer to *1)	Basic KTU EXP KTU	SLOT 1~8 SLOT 1~8	SLOT 1, A
BRT(4)-U( )	C		O	O
BSU(2)-U( )	B		O	
CCH(4)-U( )	H		O	
COI(4)-U( )	C		O	O
COI(8)-U( )	C		O	
COID(4)-U( )	C		O	O
COID(8)-U( )	C		O	O
DID(4)-U( )	C		O	
DPH(4)-U( )	—		O	
ECR-U( )	—		O	
ESI(8)-U( )	T		O	
ESIB(8)/(16)-U( )	T		O	
HUB(8)-U( )	U		O	
MG(8)-U( )	C		O	
MIFA-U( )	—			O
MIFM-U( )	—			O
OPX(2)-U( )	T		O	
PBR( )-U( )	—		O	
PRT(1)-U( )	C		O	
SLI(4)-U( )	T		O	
SLI(8)-U( )/CNF(8)-U( )	T		O	
TLI(2)-U( )	C		O	
VDH2(8)-U( )	T		O	

\*1 C: Port Number of CO/PBX Line  
 T: Telephone Port Number (smallest number is displayed)  
 V: Voice Recording Service Package  
 -: No Display  
 B: BSU No.  
 H: CCH No.  
 U: HUB No.  
 O: Enabled  
 Space: Disabled

### Related Programming

M.B. Number	Memory Block Name
7-3-00	MIF (ACD) Assignment
7-3-01	MIF (LCR) Assignment
7-3-02	MIF (SMDR) Assignment
7-3-03	MIF (UCD) Assignment
7-3-04	MIF (Caller ID) Assignment
1-2-04	Call Arrival Key Block Assignment
1-2-21	PHS Telephone Assignment

## N

- ETU interface cards are assigned automatically during initial power up.
- ESI(8)-U( ) ETU with ports 01 and 02 cannot be changed.
- When ETU system capacity is exceeded, ERROR is displayed on the LCD, and the Transfer key cannot be used to write data.
- When changing an interface slot assignment to a different ETU, use the following procedure:
  - Remove the ETU installed in the slot.
    -  Power off ACD(8), VoIP, VMS, IPCA, or FMS ETU before removing it.
  - Program the slot for new ETU in this Memory Block.
  - Install the new ETU.
- VMS(2)/FMS(2)-U( ) ETU must be assigned as a VMS(4)/FMS(4)-U( ) ETU.
- Eight BSU(2)-U( ) ETUs can be installed in the EXP Electra Elite IPK. Only three can be installed in the Basic Electra Elite IPK.
- Page 2, LK 5 is used for indication only. The VDH2(8)-U( ) ETU cannot be assigned.
- Refer to the Features and Specifications Manual, Universal Slots for maximum capacities

# Telephone Type Assignment

## General Description

Use this Memory Block to specify the type of device that is connected to an ESI port.

## Display

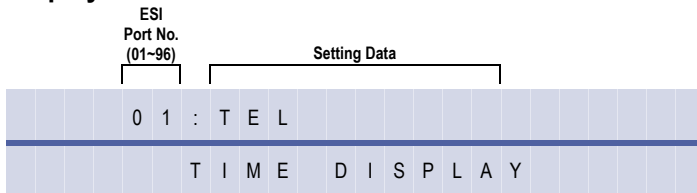

System Mode  
**7**

Telephone  
**2**

Data No.  
—



PC Programming  
 + BS

## Settings

LK 1	LK 2	LK 3	LK 4
Non	Telephone	DSS Con-sole	SLT Adapter
LK 5	LK 6	LK 7	LK 8
		Digital Voice Mail	

The shaded area indicates the default setting.

## Programming Procedures

- 1 Go off-line.
- 2 Press LK7 + LK2 to access the Memory Block.
- 3 To change data, press the corresponding CO/PBX line key.  
**Note:** Use the following to enter data:  
 : Next Tel Port No.
- 4 Press  to write the data.
- 5 Press  to go back on-line.

## Related Programming

M.B. Number	Memory Block Name
	Refer to <i>Chapter 2, Guide to Feature Programming</i> .

## N

1. Only Multiline Terminals can be assigned to ports 01 and 02.
2. A maximum of four Attendant Add-On Consoles can be installed in the system.
3. A maximum of eight SLT(1)-U( ) ADP adaptors can be installed in the system.
4. A maximum of eight Digital Voice Mail ports are available.
5. When assigning SLT adaptors or Digital Voice Mail ports, Memory Block , 4-10 , Station Number Assignment must be reassigned also.
6. If more than one DSS console is assigned, make sure that the order of assignment is as follows:
  - Ⓛ DSS1 must always be a lower port than DSS2
  - Ⓛ DSS2 must be a lower port than DSS 3
  - Ⓛ DSS3 must be a lower port than DSS 4

# MIF (ACD) Assignment

## General Description

Use this Memory Block to enable the Automatic Call Distribution (ACD) function of the MIFA-U( ) ETU.

## Display

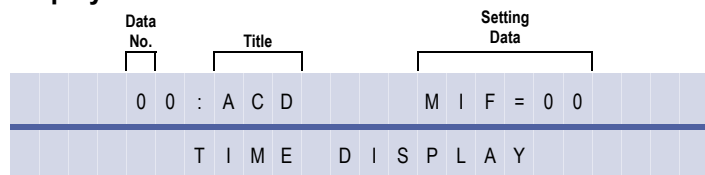

System Mode  
7

MIF  
3

Data No.  
00

PC Programming  
 + BS

## Programming Procedures

1	Go off-line.	
2	Press LK7 + LK3 to access the Memory Block.	
3	Use the dial pad to enter data. <b>Note:</b> Use the following to enter data: <ul style="list-style-type: none"> <li>* to move the cursor left</li> <li># to move the cursor right</li> <li>0 (OFF) ~ 9 (MAX) to enter numeric data</li> </ul> <b>Setting Data 00, 01, 02</b>	<b>Default Values</b> No Assignment (00)
4	Press  to write the data.	
5	Press  to go back on-line.	

## Related Programming

No related programming is necessary for this Memory Block.

**N** The ACD feature requires a KMA(1.0)U unit to be installed on the MIFA-U( ) ETU.





# MIF (SMDR) Assignment

## General Description

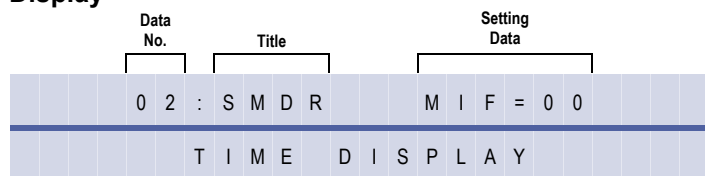

Use this Memory Block to enable the Station Message Detail Reporting (SMDR) function on the MIFM-U( ) ETU.

## Display



*System Mode*  
**7**  
*MIF*  
**3**  
*Data No.*  
**02**  
*PC Programming*  
 + BS

## Programming Procedures

1	Go off-line.	
2	Press LK7 + LK3 + * + * + 0 (OPES) 2 (ASC) to access the Memory Block.	
3	Use the dial pad to enter data. <b>Note:</b> Use the following to enter data: * to move the cursor left # to move the cursor right 0 (OPES) ~ 9 (MAX) to enter numeric data <b>Setting Data 00, 01, 02</b>	<b>Default Values</b> Default Value No Assignment (00)
4	Press  to write the data.	
5	Press  to go back on-line.	

## Related Programming

No related programming is necessary for this Memory Block.

# MIF (UCD) Assignment

## General Description

Use this Memory Block to enable the Uniform Call Distribution (UCD) function on the MIFA-U( ) ETU.

## Display

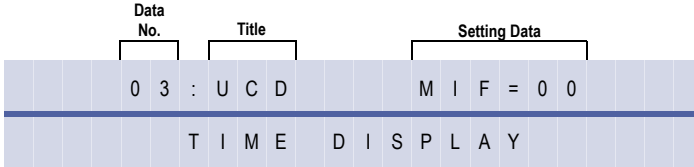

System Mode  
**7**  
 MIF  
**3**  
 Data No.  
**03**  
 PC Programming  
 + BS

## Programming Procedures

1	Go off-line.	
2	Press LK7 + LK3 + * + * + 0 (OFF) 3 (SET) to access the Memory Block.	
3	Use the dial pad to enter data. <b>Note:</b> Use the following are used when entering data: * to move the cursor left # to move the cursor right 0 (OFF) ~ 9 (MAX) to enter numeric data <b>Setting Data 00, 01, 02</b>	<b>Default Values</b> No Assignment (00)
4	Press Transfer to write the data.	
5	Press Speaker to go back on-line.	

## Related Programming

No related programming is necessary for this Memory Block.

# MIF (Caller ID) Assignment

*System Mode*  
**7**  
*MIF*  
**3**  
*Data No.*  
**04**  
*PC Programming*  
 + BS

## General Description

Use this Memory Block to enable the Caller ID scrolling or outdial function on the MIFM-U( ) ETU. Basic Caller ID works without an MIFM-U( ) ETU installed.

## Display

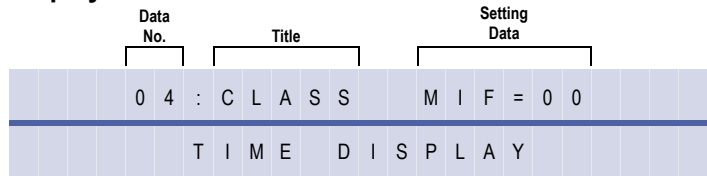

## Programming Procedures

<b>1</b>	Go off-line.	
<b>2</b>	Press LK7 + LK3 + * + * + 0 (OPER) 4 (CH) to access the Memory Block.	
<b>3</b>	Use the dial pad to enter data. <b>Note:</b> Use the following to enter data: * to move the cursor left # to move the cursor right 0 (OPER) ~ 9 (EXT) to enter numeric data <b>Setting Data 00, 01, 02</b>	<b>Default Values</b> No Function (00)
<b>4</b>	Press Transfer to write the data.	
<b>5</b>	Press Speaker to go back on-line.	

## Related Programming

No related programming is necessary for this Memory Block.



Caller ID scrolling and outdial must have the KMM(XXX)U installed on the MIFM-U( ) ETU.



# ROM Version Confirmation

## General Description

Use this Memory Block to confirm the program version without removing the card from the KSU.

## Display

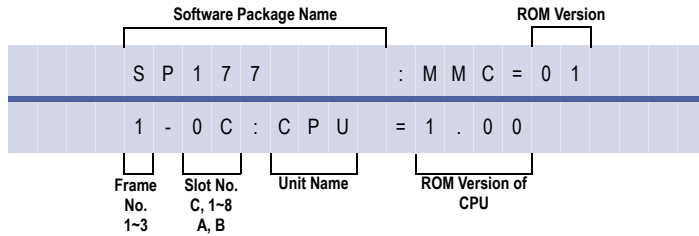

System Mode  
8

ROM  
1

Data No.  
—

PC Programming

+ BCM

## Programming Procedures

- 1 Go off-line.
- 2 Press LK8 + LK1 to access the Memory Block.
- 3 Press the corresponding CO/PBX line key to change the data option.  
**Note:** Use the following to enter data:  
 (Recall) to change from one operating system to the next operating system  
 Enter (7) ~ (8) = Frame No. 1~3, Slot No 1~8  
 (9) = Slot Number A  
 (0) = Slot Number B  
 (Recall) = Slot Number C
- 4 Press (Transfer) and the type of unit, in the order of slot number and ROM version is displayed each time a CO/PBX line key is pressed.
 

	0 9	:		= 0 0
	1 — 0 1	:	B R T 4	= 0 0

**Programming Procedures (Continued)**

**5** Frame number, slot number, interface name, and ROM Version are shown on the display. There are three display patterns.

1) For basic frame (frame 1 or slot C) CPU:

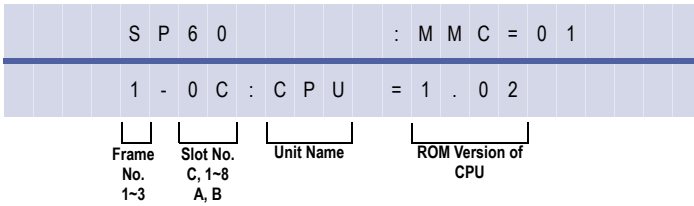

2) For slot C of expansion frame:

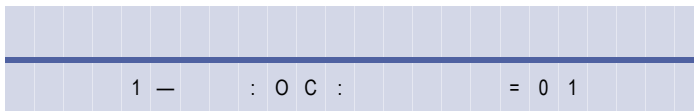

3) For another slot type:

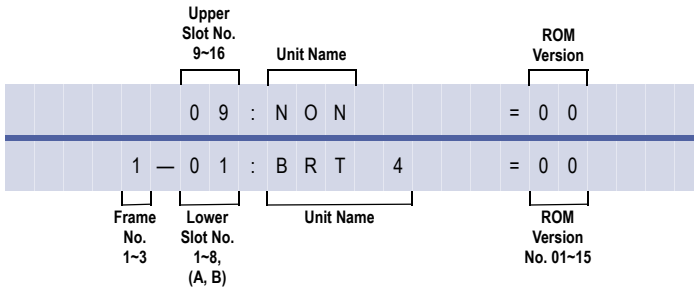

**6** Press  to write the data.

**7** Press  to go back on-line.

**Related Programming**

No related programming is necessary for this Memory Block.

# System Speed Dial Memory Clear

## General Description

Use this Memory Block to clear all System Speed Dial programming.

System Mode  
**8**

Spd-Clr-Sys  
**2**

Data No.  
—

PC Programming  
 + BE







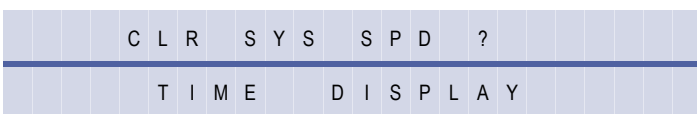























































# N

Before programming this procedure, please ensure you understand completely the affect of erasing all System Speed Dial buffers in the system.

## Display



## Programming Procedures

<b>1</b>	Go off-line.																
<b>2</b>	Press LK8 + LK2 to access the Memory Block.																
<b>3</b>	When the system display prompt indicates CLR TEL SPD?, the first four CO/PBX lines light red. <div style="display: flex; justify-content: space-around; margin-top: 5px;"> <div style="text-align: center;"> Red</div> <div style="text-align: center;"> Red</div> <div style="text-align: center;"> Red</div> <div style="text-align: center;"> Red</div> </div>																
<b>4</b>	Press     to enter the fixed password. <b>Note:</b> When entering the password the top line of CO/PBX LEDs change from red to green each time a number of the password is pressed. <div style="margin-top: 10px;">  = <table style="display: inline-table; border-collapse: collapse;"><tr><td style="text-align: center;"> Green</td><td style="text-align: center;"> Red</td><td style="text-align: center;"> Red</td><td style="text-align: center;"> Red</td></tr></table> </div> <div style="margin-top: 10px;">  = <table style="display: inline-table; border-collapse: collapse;"><tr><td style="text-align: center;"> Green</td><td style="text-align: center;"> Green</td><td style="text-align: center;"> Red</td><td style="text-align: center;"> Red</td></tr></table> </div> <div style="margin-top: 10px;">  = <table style="display: inline-table; border-collapse: collapse;"><tr><td style="text-align: center;"> Green</td><td style="text-align: center;"> Green</td><td style="text-align: center;"> Green</td><td style="text-align: center;"> Red</td></tr></table> </div> <div style="margin-top: 10px;">  = <table style="display: inline-table; border-collapse: collapse;"><tr><td style="text-align: center;"> Green</td><td style="text-align: center;"> Green</td><td style="text-align: center;"> Green</td><td style="text-align: center;"> Green</td></tr></table> </div>	 Green	 Red	 Red	 Red	 Green	 Green	 Red	 Red	 Green	 Green	 Green	 Red	 Green	 Green	 Green	 Green
 Green	 Red	 Red	 Red														
 Green	 Green	 Red	 Red														
 Green	 Green	 Green	 Red														
 Green	 Green	 Green	 Green														
<b>5</b>	Press  to write the data.																
<b>6</b>	Press  to go back on-line.																

## Related Programming

No related programming is necessary for this Memory Block.

# Station Speed Dial Memory Clear

Use this Memory Block to clear the Station Speed Dial memories of all programmed Speed Dial numbers.

*System Mode*  
**8**  
*Spd-Clr-Sta*  
**3**  
*Data No.*  
**—**  
*PC Programming*  
 + BE

# N





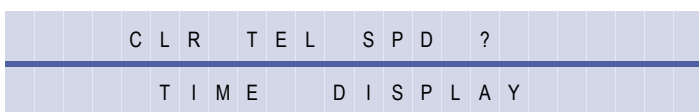



Before programming this procedure, please ensure you understand completely the affect of erasing all Station Speed Dial buffers in the system.

## Display

























## Programming Procedures

- 1 Go off-line.
- 2 Press LK8 + LK3 to access the Memory Block.
- 3 When the system display prompt indicates CLR TEL SPD?, the first four CO/PBX lines light red.
 

			
Red	Red	Red	Red
- 4 Press     to enter the fixed password.
 

**Note:** When entering the password the top line of CO/PBX LEDs change from red to green each time a number of the password is pressed.

 =				
	Green	Red	Red	Red
 =				
	Green	Green	Red	Red
 =				
	Green	Green	Green	Red
 =				
	Green	Green	Green	Green
- 5 Press  to write the data.
- 6 Press  to go back on-line.

## Related Programming

No related programming is necessary for this Memory Block.

# Second Initialisation

## General Description





Use this Memory Block to initialise all the system hardware. All system software and user programming are retained after the Second Initialisation.







## Display



*System Mode*  
**8**  
*CO-Line*  
**8**  
*Data No.*  
**8800**  
*PC Programming*  
 + CI

## Programming Procedures

- 1 Go off-line.
- 2 Press LK8 + LK8 +     to access the Memory Block.
- 3 When the system display prompt indicates CPU RESET?, the first four CO/PBX lines light red.
 

			
○	○	○	○
Red	Red	Red	Red
- 4 Press  to begin the initialisation process.
- 5 Press  to go back on-line.

## Related Programming

No related programming is necessary for this Memory Block.

# N

## IMPORTANT

If VMS, FMS, ACD and/or IPT cards installed in the system, please ensure all cards have completed their startup sequence before performing a second initialisation.

These cards are considered fully 'started up' about 5 minutes after power is applied.

# Clock/Calendar Setting

System Mode	—
Data No.	—
Submode	—
PC Programming	—

## General Description

This Memory Block is used to set the time and date that are displayed on the Multiline Terminals.

## Display

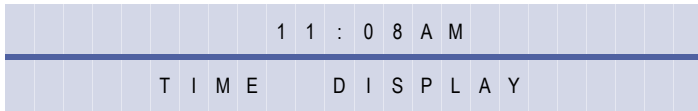

## Programming Procedures

1	Go off-line.
2	<p>Press <b>Feature</b> + <b>9</b> + <b>#</b> to access the Memory Block.</p> <p><b>Note:</b> Use the following to enter data:</p> <ul style="list-style-type: none"> <li><b>*</b> moves the cursor left</li> <li><b>#</b> moves the cursor right</li> <li><b>0</b> ~ <b>9</b> to enter numeric Time, Date, Month, Year</li> <li><b>Recall</b> to switch a.m./p.m. and to switch month and weekdays</li> <li><b>Recall</b> while cursor is at the Day or Month to allow the user to scroll through the selections</li> </ul> <p>All other items can be changed by moving the cursor to the desired position and entering the data using the dial pad (Refer to the example).</p>
3	Press <b>Transfer</b> to write the data.
4	Press <b>Speaker</b> to go back on-line.

## Related Programming

No related programming is necessary for this Memory Block.



1. This station operation is performed by the Attendant station.
2. The Clock/Calendar cannot be set using PC Programming.

**Example:** To change the time and the date to 12:00 p.m. Sunday, December 31, 2004:



1. Using the dial pad, press **7** **2** **0** **0**.



2. Press **Recall** .

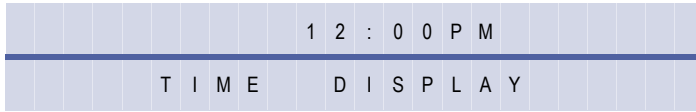

3. Press **Hold** .

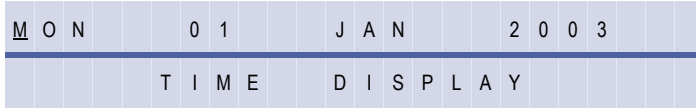

4. Press **Recall** until SUN is displayed.

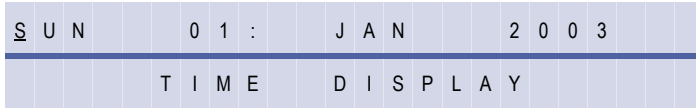

5. Move the cursor to the 01 position.

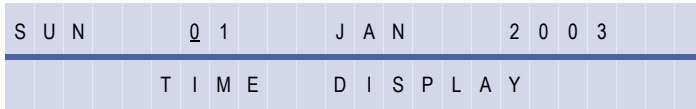

6. Using the dial pad, press **3** **1** .

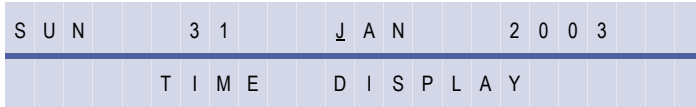

7. Press **Recall** until DEC is displayed.



8. Move the cursor to the 2003 position.



9. Using the dial pad, press **0** **4** .



10. Press **Feature** .

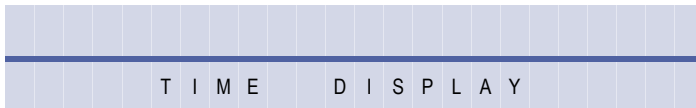

THIS PAGE INTENTIONALLY LEFT BLANK



## SECTION 5

### FUNCTION TIMER CHART

The chart on the following pages provides a list of timers that can be programmed in the system. The information is listed numerically by Memory Block number. A brief definition and the timing value is given for each timer.

Table 1-3: Function Timer Chart

Timer	Memory Block	Definition	Timing Value		
			Minimum	Default	Maximum
Pause Time Selection	1-1-00	Duration when no signal is being sent to a CO/PBX line.	1 sec.	3 sec.	3 sec.
DP Interdigit Time Selection	1-1-01	Minimum interval between dialling signals in Dial Pulse dialling.	650/500 ms.	800/800 ms.	800/800 ms.
Hookflash Time Selection	1-1-02	Timing of a CO/PBX hookflash from the Recall key of a Multiline Terminal or a Single Line Telephone to the CO/PBX line.	20 ms.	600 ms.	5000 ms. (5 sec.)
Hold Recall Timer Selection (Non-Exclusive Hold)	1-1-03	Specify the time before a held CO/PBX line recalls the station that put that line on hold.	25 sec.	25 sec.	No Limit
Automatic Redial Time Selection	1-1-04	Defines the redial timing parameters when automatic redial is set to a busy CO/PBX number.	30 sec.		60 sec.
Start Timer Selection	1-1-05	Specify the time for after dialling and the start of call duration display and Talk Start Timer.	2 sec.	10 sec.	70 sec.
CO/PBX Incoming Ringing Alarm Time Selection	1-1-06	Specify the time from receiving an incoming CO/PBX call until the ringing tone changes to a different ringing tone level if the call is not answered.	10 sec.	No Limit	No Limit
Tie Line Delay Ringing Timer Selection	1-1-07	Specify the delay interval between the time a telephone rings (accessed by a ringing call in the Tie/DID line) and the time other telephones start ringing.	10 sec.	No Limit	No Limit
Station Transfer/Camp-On Recall Timer Selection	1-1-12	The time before a ring transferred call recalls to the station that transferred the call.	25 sec.	45 sec.	No Limit
Trunk Queuing Timeout Selection	1-1-37	Specify the time queuing for a CO/PBX line recalls before being automatically cancelled.	10 sec.	10 sec.	60 sec.
CO/PBX Prepause Timer Selection	1-1-57	Specify the pause time before dialled digits are sent over a CO/PBX line.	None	1 sec.	15 sec.

Table 1-3: Function Timer Chart (Continued)

Timer	Memory Block	Definition	Timing Value		
			Minimum	Default	Maximum
Hold Recall Time Selection (Exclusive)	1-1-63	Specify the time for Exclusive Hold Recall.	30 sec.	1 min.	No Limit
Attendant Add-On Console Transfer/ Camp-On Recall Timer Selection	1-1-64	Specify the time for a ring transfer from the DSS Console until the recall alarm is sent.	30 sec.	1 min.	10 min.
First Delay Announcement Start Time Selection	1-1-71	Specify the time between receiving an incoming CO call and sending the First Delay Announcement to the caller.	0 sec.	20 sec.	60 sec.
First to Second Delay Announcement Interval Time Selection	1-1-73	Specify the time between the First and Second Delay Announcement.	0 sec.	20 sec.	No Limit
Second Delay Announcement Repeat Interval Time Selection	1-1-75	Specify the time between repeated Second Delay Announcement.	0 sec.	20 sec.	No Limit
Delayed Ringing Timer Assignment (CO)	1-1-77	Specify the time for delayed ringing on incoming outside line calls.	0 sec.	15 sec	99 sec.
ISDN DTMF Duration/Interdigit Time Selection	1-180	Specify tone duration and interdigit time of Dual-Tone Multifrequency (DTMF) signals for the ISDN Trunk.	70/60 ms.	100/70 ms.	900/200 ms.
ISDN Dial Interval Timer Selection	1-1-81	Specify the dial interval timer for ISDN lines when dialling from a PHS	2 sec.	8 sec.	32 sec.
Internal Paging Timeout Selection	1-2-00	Specify the time allowed for paging.	90 sec.	90 sec.	No Limit
Automatic Callback Release Timer Selection	1-2-02	Time duration before Automatic Callback is automatically cancelled.	30 sec.	30 min.	30 min.
Call Forward No Answer Timer Selection	1-2-22	Specify time before ICM or Trunk calls are forwarded.	4 sec.	8 sec.	60 sec.
System Call Park Recall Time Selection	1-2-23	Time before a parked call recalls to the station that parked the call.	30 sec.	1 min	10 min.

Table 1-3: Function Timer Chart (Continued)

Timer	Memory Block	Definition	Timing Value		
			Minimum	Default	Maximum
Delayed Ringing Timer Assignment (ICM)	1-2-26	Specify the time for delayed ringing on internal calls.	0 sec.	10 sec.	99 sec.
PS Out of Area Timer Selection*	1-2-30	Assigns Out of Area PS Timer	00 sec.	12 sec.	99 sec.
Bounce Protect Time Selection	1-3-01	Specify the time before a valid hookflash is detected from a Single Line Telephone or Voice Mail System.	0 ms.	300 ms.	1500 ms.
First Digit PBR Release Timer Selection	1-3-03	Specify the time that a receiver is connected when a DTMF Single Line Telephone user is dialling.	10 sec.	10 sec.	60 sec.
Hookflash Start Time Selection	1-3-05	Specify a minimum hookflash duration for a Single Line Telephone to receive a second dial tone.	40 ms.	290 ms.	790 ms.
Hookflash End Time Selection	1-3-06	Specify a maximum duration from a Single Line Telephone to receive a second dial tone (HT = Hookflash Start Time).	HST + 0 ms.	HST + 700 ms.	HST + 1500 ms.
Voice Mail DTMF Delay Timer Selection	1-3-08	Specify the delay time before DTMF tones are sent to the VMI port.	0 sec.	1 sec.	8 sec.
Voice Mail Disconnect Time Selection	1-3-09	Specify the sending time of a disconnect signal that is sent to the connected equipment.	.5 sec.	1.5 sec.	3.5 sec.
Voice Mail DTMF Duration/Interdigit Time Selection	1-3-10	Specify the DTMF duration/interdigit time for voice mail.	60/70 ms.	110/80 ms.	810/190 ms.
Tandem Transfer Automatic Disconnect Timer Selection	1-4-00	Specify a maximum time before automatic disconnect of a Trunk-to-Trunk transfer occurs.	30 min.	1 hr.	3 hr.
Tandem Transfer Automatic Disconnect Timer Selection*	1-4-00	Specify a maximum time before automatic disconnect of a Trunk-to-Trunk transfer occurs.	000 min.	060 min.	999 min.
Automated Attendant First Digit PBR Release Timer Selection	1-4-01	Specify the PBR connection time to the Automated Attendant trunk to receive the DTMF signal from the calling party before automatically disconnecting.	5 sec.	20 sec.	60 sec.

Table 1-3: Function Timer Chart (Continued)

Timer	Memory Block	Definition	Timing Value		
			Minimum	Default	Maximum
Automated Attendant Transfer Delayed Ringing Time Selection	1-4-02	Specify the time for a No Answer at the transferred station before the Automated Attendant rings a predetermined station.	10 sec.	No Limit	No Limit
Automated Attendant No Answer Disconnect Time Selection	1-4-03	Determine how long the Automated Attendant rings a station before dropping the call.	1 min.	2 min.	4 min.
Automated Attendant Answer Delay Time Assignment	1-4-13	Assign the number of seconds before the Automated Attendant answers an incoming CO/PBX call when there is no answer.	0 sec.	4 sec.	99 sec.
Automated Attendant 1st to 2nd Delay Announcement Interval Time Selection	1-4-19	Specify the interval time between the Automated Attendant Delay Announcement messages	0 min.	4 min.	20 min.
Automated Attendant Delay Announcement Disconnect Time Selection	1-4-20	Establishes how long the Automated Attendant rings the stations before disconnecting the caller. Only applies when the Automated Attendant is set to the Delay Announcement Mode.	0 sec.	30 sec.	20 min.
SMDR Valid Call Timer Assignment	1-5-25	Minimum duration of an outside call before the system provides an SMDR report (Set from 0~99 seconds in 10-second increments).	0 sec.	40 sec.	990 sec.
Doorphone Display Time Selection	1-7-01	Define how long a door phone call signals a station before it times out.	10 sec.	10 sec.	90 sec.
External Paging Timeout Selection	1-7-06	The time before an external paging is automatically disconnected.	30 sec.	5 min.	No Limit
External Speaker Chime Start Time Selection	1-7-09	Assign the delay after an external paging code is dialed and before the paging alert tone is provided. Only used when paging alert tone (4 tones) is assigned in Memory Block 1-7-08 (External Speaker Chime Selection).	0 ms.	700 ms.	1500 ms.

Table 1-3: Function Timer Chart (Continued)

Timer	Memory Block	Definition	Timing Value		
			Minimum	Default	Maximum
PBR Interdigit Release Timer Selection	1-8-10	Specify the interdigit release time for the PBR.	3 sec.	7 sec.	10 sec.
System Refresh Timer Assignment	1-8-11	Assign the system refresh time.	No Refresh	4 hr.	24 hrs.
VRS Message Recording Time Selection	1-8-12	Specify the time length and number of messages for each VRS channel	15 sec.	15 sec.	120 sec.
ACD Hunt Timer	1-8-40	Assigns the time value for hunting among ACD/UCD agents that do not answer.	10 sec.	10 sec.	No Limit
Trunk DTMF Duration/Interdigit Selection	3-15	Specify the tone duration and interdigit time of DTMF signals (Expressed as duration/interdigit time).	60/70 ms.	110/80 ms.	810/190 ms.
Tie Line Prepause Time Selection	3-16	Specify the prepause time for when the originating side can send dial pulse or DTMF to a distant system.	0 sec.	0 sec.	13 sec.
Tie line Answer Detect Time Selection	3-17	Specify the duration between the time when the receiving system answers and the time when it is recognised as an answer.	0 ms.	520 ms.	1950 ms.
Tie Line Release Detect Time Selection	3-18	Specify the duration between the circuit disconnection detection on the Tie line on the distant system side and the time it is recognised as Tie Line Release.	0 ms.	520 ms.	1950 ms.
Tie Line/CO/PBX Incoming Signal Detect Time Selection	3-19	Specify the time between the detection of an incoming signal from another Xen system and the time when the acknowledgment signal is sent (Expressed as Wink Start/Delay/COI in ms.).	0/0/5	520/120/200	1950/450/800
Tie Line Loop Off-Guard Time Selection	3-20	Assign loop off-guard protection to prevent noise that may cause the system to be unable to answer an incoming Tie line.	0 sec.	2 sec.	13 sec.
Tie Line Length of Wink Signal Selection	3-21	Specify the time between the incoming signal detection from another Xen system and when the acknowledgment signal is sent out.	30 ms.	180 ms.	480 ms.

Table 1-3: Function Timer Chart (Continued)

Timer	Memory Block	Definition	Timing Value		
			Minimum	Default	Maximum
Tie Line Length of Delay Signal Selection	3-22	Specify the time a delay pulse is sent to another system.	0 ms.	300 ms.	4500 ms.
Tie Line Incoming Interdigit Timeout Selection	3-24	Specify the maximum time during the incoming call detection process. If an address signal is not received within a specified time, an error tone is returned to the other system.	1 sec.	6 sec.	No Limit
Tie Line Wink/Delay Signal Detect Timeout Selection	3-25	Specify the maximum time for receiving an acknowledgment signal from a distant system before sending a busy tone.	1 sec.	7 sec.	No Limit
Disconnect Recognition Time Selection	3-33	Specify a minimum time for a disconnected circuit to be accessed again.	0 sec.	0.3 sec	1.5 sec.
DIT Delay Answer Timer Selection	3-61	This Memory Block is used to specify the time and incoming CO/PBX call will ring before changing to DIT.	0 sec.	5 sec.	60 sec.

## SECTION 6

### CODE RESTRICTION

#### 6.1 General

The Xen systems provide an advanced method of restricting outgoing calls based on the first eight digits dialed. Code Restriction denies placement of outside calls based on Trunk groups and accommodates equal access to other common carriers (OCC). This eliminates unauthorised calls and configures system calling functions to provide cost control.

System Programming has 16 Code Restrictions Classes. Class 00 is fixed and allows free dialling. Class 15 is fixed and denies all outside calls. Classes 01~14 are programmable in system software. Stations are assigned per station to a Code Restriction Class. A separate Day Mode and Night Mode station to Code Restriction Class assignment is available.

#### 6.2 Default Assignments

At default, all stations are assigned to Code Restriction Class 00 for both Day and Night Mode to allow free dialling.

At default, the Code Restriction Classes are set up with the following restrictions to provide the most common Code Restriction requirements and simplify Code Restriction programming.

Class	Deny	Allow
Class 01:		000, 1144x Calls Only
At default: <ul style="list-style-type: none"> <li>• Class 02~14 not assigned.</li> <li>• All OCC calls are denied for Code Restriction Classes 01~14.</li> <li>• System Speed Dial buffers override Code Restriction Classes 01~14.</li> <li>• When Station Lockout is set at a station the station restricted for all calls, except emergency calls.</li> <li>• Digit Restriction is not assigned.</li> </ul>		

# N

Refer to Section 6.5 *Code Restriction Tables (Default Values)* on page 532.

### 6.3 Memory Blocks

The following related Memory Blocks are used when assigning Code Restriction.

Title	Memory Block
Trunk to Tenant Assignment	2-01
Trunk-to-Trunk Group Assignment	3-03
Trunk Type Selection	3-91
PBX/CTX Access Code Assignment I	1-1-24
PBX/CTX Access Code Assignment II	1-1-25
OCC Table Assignment	1-1-67
OCC Table to Trunk Group Assignment	5-03
8-Digit Matching Table to OCC Table Assignment	1-1-68
8-Digit Matching Table to Normal Dial Assignment	1-1-66
8-Digit Matching Table to Trunk Group Assignment	5-02
8-Digit Matching Table Assignment	1-1-60
8-Digit Matching Table to Class Assignment	1-1-61
Code Restriction Class Allow/Deny Assignment	1-1-65
System Speed Dial Restriction by Tenant	1-1-18
System Speed Dial Override by Class Selection	1-1-62
Tie Line Code Restriction Assignment	1-1-69
Code Restriction Class Assignment When Lockout is Set	1-1-70
CO Feature Codes Service for Code Restriction	1-1-82
Trunk Digit Restriction	4-32
Code Restriction Class Assignment (Day Mode)	4-07
Code Restriction Class Assignment (Night Mode)	4-08
Telephone to Tenant Assignment	4-09

### 6.4 Memory Block Description

#### 6.4.1 General

This section describes the function of the Memory Blocks directly related to Code Restriction. Some Memory Blocks from the previous list are not described here but are included because of their effect on Code Restriction (e.g., Trunk to Tenant Assignment). Code Restriction is based on Trunk group and consideration should be given to this Memory Block because stations are assigned to a tenant, and trunks are assigned to a Trunk group.



## 6.4.2 OCC Assignment/Operation

### OCC Table Assignment

(Memory Block 1-1-67)

This Memory Block allows an OCC Access Code (maximum of eight digits) to be assigned. System Programming has 16 OCC Tables (01~16). Each table can have one OCC Access Code assigned.

### OCC Table to Trunk Group Assignment

(Memory Block 5-03)

This Memory Block assigns Trunk groups to the OCC Tables. Any combination of Trunk groups can be assigned to the OCC Tables.

### 8-Digit Matching Table to OCC Table Assignment

(Memory Block 1-1-68)

This Memory Block assigns the 8-Digit Matching Table to the OCC Tables. Any combination of 8-Digit Matching Tables can be assigned to the OCC Tables.

### OCC Operation

When a restricted station user dials an OCC Access Code, the system searches the OCC Tables for a match. If no match is found, the user is allowed free dialling. If a match is found, the system monitors the eight digits dialed and searches the 8-Digit Matching Tables assigned to the OCC Table. The system searches only the 8-Digit Matching Tables assigned to the Code Restriction Class the station is assigned to and has the Trunk group assigned to it for the in-use trunk the station is on. If the interdigit time of the dialling party exceeds 10 seconds while the station user is dialling on an outside line, and the system is searching the assigned tables, the system automatically drops the call.

## 6.4.3 8-Digit Matching Table Assignment/Operation

### 8-Digit Matching Table to Normal Dial Assignment

(Memory Block 1-1-66)

This Memory Block assigns the 8-Digit Matching Table to be Used or Unused for non-OCC calls. If an 8-Digit Matching Table is assigned as Unused, the table is used only for OCC calls. There are sixteen 8-Digit Matching Tables (00~15) in System Programming. Each table is independently assigned to be Used or Unused.

### 8-Digit Matching Table to Trunk Group Assignment

(Memory Block 5-02)

This Memory Block assigns Trunk groups to the 8-Digit Matching Tables. Any combination of Trunk groups can be assigned to the 8-Digit Matching Tables.

### 8-Digit Matching Table Assignment

(Memory Block 1-1-60)

This Memory Block assigns the 8-Digit Matching Tables. Each 8-Digit Matching Table can have sixteen 8-digit entries. To cover the many possible combinations (without listing each individual number), code restriction letters can be used in place of digits. The code restriction letters used and their numerical values are as follows:

X = 0~9, \*, and #

P = 0 and 1

N = 2~9

When 1X is entered in a table, and the table is assigned as a day table in the 8-Digit Matching Table to Class Assignment, any 1 + any digit call is denied if the table is used. Using X, P, and N accommodates several combinations with just one entry.

---

# N

The Trunk Access Code should not be placed in the 8-Digit Matching Table. Code Restriction starts after a trunk is seized.

### 8-Digit Matching Table to Class Assignment

(Memory Block 1-1-61)

This Memory Block assigns the 8-Digit Matching Tables to the Code Restriction Classes. The 8-Digit Matching Tables are also assigned as Allow/Deny Tables in this Memory Block. Any combination of 8-Digit Matching Tables (Allow, Deny, or Not Used) can be assigned to Code Restriction Classes 01~14. Classes 00 and 15 are fixed and are non programmable.

### Code Restriction Class Allow/Deny Selection

(Memory Block 1-1-65)

This Memory Block assigns the Code Restriction Classes (01~14) as Allow or Deny. This assignment is used when there is no match or when there is an overlap (duplicate numbers in tables with opposite Allow/Deny assignments) of number in the 8-Digit Matching Tables.

### 8-Digit Matching Table Operations

The 8-Digit Matching Tables are used to restrict specific or all OCC calls and non-OCC calls. To understand the relationship of the 8-Digit Matching Tables with OCC calls, refer to *6.4.2 OCC Assignment/Operation on page 529*.

When a restricted station user makes a non-OCC call, the system monitors the first eight digits dialed and searches the 8-Digit Matching Tables assigned for Used in Memory Block 1-1-66 (8-Digit Matching Table to Normal Dial Assignment).

The system searches only the 8-Digit Matching Tables assigned to the Code Restriction Class the station is assigned to and has the Trunk group assigned to it for the in-use trunk the station is on.

If a match is found, the system looks at the 8-Digit Matching Table to Class Assignment for the Allow or Deny Assignment. If the table is assigned as Allow, the call is allowed. If the table is assigned as Deny, the call is denied.

If a match is not found or a duplicate match is made with opposite Allow/Deny Assignments, the system looks at the class Allow/Deny Assignment. If the class is assigned as Allow, the call is allowed. If the Class is assigned as Deny, the call is denied. If the interdigit time of the dialling party exceeds 10 seconds while the station user is dialling on an outside line, and the system is searching the assigned tables, the system automatically drops the call.

#### **6.4.4 System Speed Dial Override by Class Selection**

(Memory Block 1-1-62)

This Memory Block allows System Speed Dial buffers to override or not override Code Restriction. Each Code Restriction Class (01~14) is assigned as Allow or Deny.

#### **6.4.5 Tie Line Code Restriction Assignment**

(Memory Block 1-1-69)

This Memory Block assigns system-wide Code Restriction to be used or not used for calls made on a Tie line.

#### **6.4.6 Code Restriction Class Assignment When Lockout is Set**

(Memory Block 1-1-70)

This Memory Block assigns the Code Restriction Class to be used when Station Lockout (Outgoing) is set at a station. Station Lockout can be set by the Attendant or from any station if allowed in System Programming.

#### **6.4.7 Code Restriction Bypass Table**

(Memory Block 1-1-82)

This Memory Block assigns a set of feature codes per system. A station user can dial these codes as the leading digits of a telephone number. The Xen system ignores these digits and applies code restriction to the remaining digits. The codes are sent to the CO as the leading digits on permitted code restriction calls.

#### **6.4.8 Trunk Digit Restriction Assignment**

(Memory Block 4-32)

This Memory Block specifies, per station, the maximum number of digits that can be dialled while on any outside line.

#### **6.4.9 Code Restriction Class Assignment (Day Mode)**

(Memory Block 4-07)

This Memory Block specifies, per station, the Code Restriction Class used when the system or stations assigned tenant is in the Day Mode.

#### **6.4.10 Code Restriction Class Assignment (Night Mode)**

(Memory Block 4-08)

This Memory Block specifies, per station, the Code Restriction Class used when the system or stations assigned tenant is in the Night Mode.

### **6.5 Code Restriction Tables (Default Values)**

#### **6.5.1 OCC Tables with Default Values**

The following Memory Blocks are displayed:

OCC Table Assignment (1-1-67)

OCC Table to Trunk Group Assignment (5-03)

8-Digit Matching Table to OCC Table Assignment (1-1-68)

	Table 01	Table 02	Table 03	Table 04
Memory Block (1-1-67)				
Memory Block (5-03)	Trunk Group 01~32	Trunk Group 01~32	Trunk Group 01~32	Trunk Group 01~32
Memory Block (1-1-68)				

	Table 05	Table 06	Table 07	Table 08
Memory Block (1-1-67)				
Memory Block (5-03)	Trunk Group 01~32	Trunk Group 01~32	Trunk Group 01~32	Trunk Group 01~32
Memory Block (1-1-68)				

	Table 09	Table 10	Table 11	Table 12
Memory Block (1-1-67)				
Memory Block (5-03)	Trunk Group 01~32	Trunk Group 01~32	Trunk Group 01~32	Trunk Group 01~32
Memory Block (1-1-68)				

	Table 13	Table 14	Table 15	Table 16
Memory Block (1-1-67)				
Memory Block (5-03)	Trunk Group 01~32	Trunk Group 01~32	Trunk Group 01~32	Trunk Group 0~32
Memory Block (1-1-68)				

Continued on next page.

**6.5.2 8-Digit Matching Tables with Default Values**

The following Memory Blocks are displayed:

8-Digit Matching Table to Normal Dial Assignment (1-1-66)

8-Digit Matching Table to Trunk Group Assignment (5-02)

8-Digit Matching Table Assignment (1-1-60)

The following designations are used in these tables:

	Table 00	Table 01	Table 02	Table 03
Memory Block (1-1-66)	Use Table	Use Table	Use Table	Use Table
Memory Block (5-02)	Trunk Group 01~32	Trunk Group 01~32	Trunk Group 01~32	Trunk Group 01~32
Memory Block (1-1-60)	00 0 0 0	00	00	00
	01 1 1 4 4 X	01	01	01
	02	02	02	02
	03	03	03	03
	04	04	04	04
	05	05	05	05
	06	06	06	06
	07	07	07	07
	08	08	08	08
	09	09	09	09
	10	10	10	10
	11	11	11	11
	12	12	12	12
	13	13	13	13
	14	14	14	14
	15	15	15	15

Note: X = --0, \*, #  
 P = 0,1  
 N = 2~9

Continued on next page

8-Digit Matching Table to Normal Dial Assignment (1-1-66)

8-Digit Matching Table to Trunk Group Assignment (5-02)

8-Digit Matching Table Assignment (1-1-60)

	Table 04	Table 05	Table 06	Table 07
Memory Block (1-1-66)	Use Table	Use Table	Use Table	Use Table
Memory Block (5-02)	Trunk Group 01~32	Trunk Group 01~32	Trunk Group 01~32	Trunk Group 01~32
Memory Block (1-1-60)	00	00	00	00
	01	01	01	01
	02	02	02	02
	03	03	03	03
	04	04	04	04
	05	05	05	05
	06	06	06	06
	07	07	07	07
	08	08	08	08
	09	09	09	09
	10	10	10	10
	11	11	11	11
	12	12	12	12
	13	13	13	13
	14	14	14	14
	15	15	15	15

Note: X = ~,9, \*, #  
 P = 0,1  
 N = 2~9

8-Digit Matching Table to Normal Dial Assignment (1-1-66)

8-Digit Matching Table to Trunk Group Assignment (5-02)

8-Digit Matching Table Assignment (1-1-60)

	Table 08	Table 09	Table 10	Table 11
Memory Block (1-1-66)	Use Table	Use Table	Use Table	Use Table
Memory Block (5-02)	Trunk Group 01~32	Trunk Group 01~32	Trunk Group 01~32	Trunk Group 01~32
Memory Block (1-1-60)	00	00	00	00
	01	01	01	01
	02	02	02	02
	03	03	03	03
	04	04	04	04
	05	05	05	05
	06	06	06	06
	07	07	07	07
	08	08	08	08
	09	09	09	09
	10	10	10	10
	11	11	11	11
	12	12	12	12
	13	13	13	13
	14	14	14	14
	15	15	15	15

Note: X = 0-9, \*, #  
 P = 0,1  
 N = 2-9

Continued on next page

Doc. No.: 8194 - Release 2.0  
 December 2004



8-Digit Matching Table to Normal Dial Assignment (1-1-66)

8-Digit Matching Table to Trunk Group Assignment (5-02)

8-Digit Matching Table Assignment (1-1-60)

	Table 12	Table 13	Table 14	Table 15
Memory Block (1-1-66)	Use Table	Use Table	Use Table	Use Table
Memory Block (5-02)	Trunk Group 01~32	Trunk Group 01~32	Trunk Group 01~32	Trunk Group 01~32
Memory Block (1-1-60)	00	00	00	00
	01	01	01	01
	02	02	02	02
	03	03	03	03
	04	04	04	04
	05	05	05	05
	06	06	06	06
	07	07	07	07
	08	08	08	08
	09	09	09	09
	10	10	10	10
	11	11	11	11
	12	12	12	12
	13	13	13	13
	14	14	14	14
	15	15	15	15

Note: X = 0~9, \*, #  
 P = 0,1  
 N = 2~9

8-Digit Matching Tables with Default Values

The following designations are used in this table:

8-Digit Matching Table to Class Assignment (1-1-61)

Class Allow/Deny Selection (1-1-65)

8-Digit  
Matching  
Table to Class  
Assignment  
  
Note: A = Allow  
D = Deny  
Blank = Not used

	8-Digit Matching Table															Class Allow/Deny Assignment	
	01	02	03	04	05	06	07	08	09	10	11	12	13	14	15		
Class 01	A																Deny
Class 02	A																Allow
Class 03	A																Allow
Class 04	A																Allow
Class 05	A																Allow
Class 06	A																Allow
Class 07	A																Allow
Class 08	A																Allow
Class 09	A																Allow
Class 10	A																Allow
Class 11	A																Allow
Class 12	A																Allow
Class 13	A																Allow
Class 14	A																Allow

### 6.6 Code Restriction Algorithm

The following chart identifies how the system checks for and processes Code Restriction assignments.

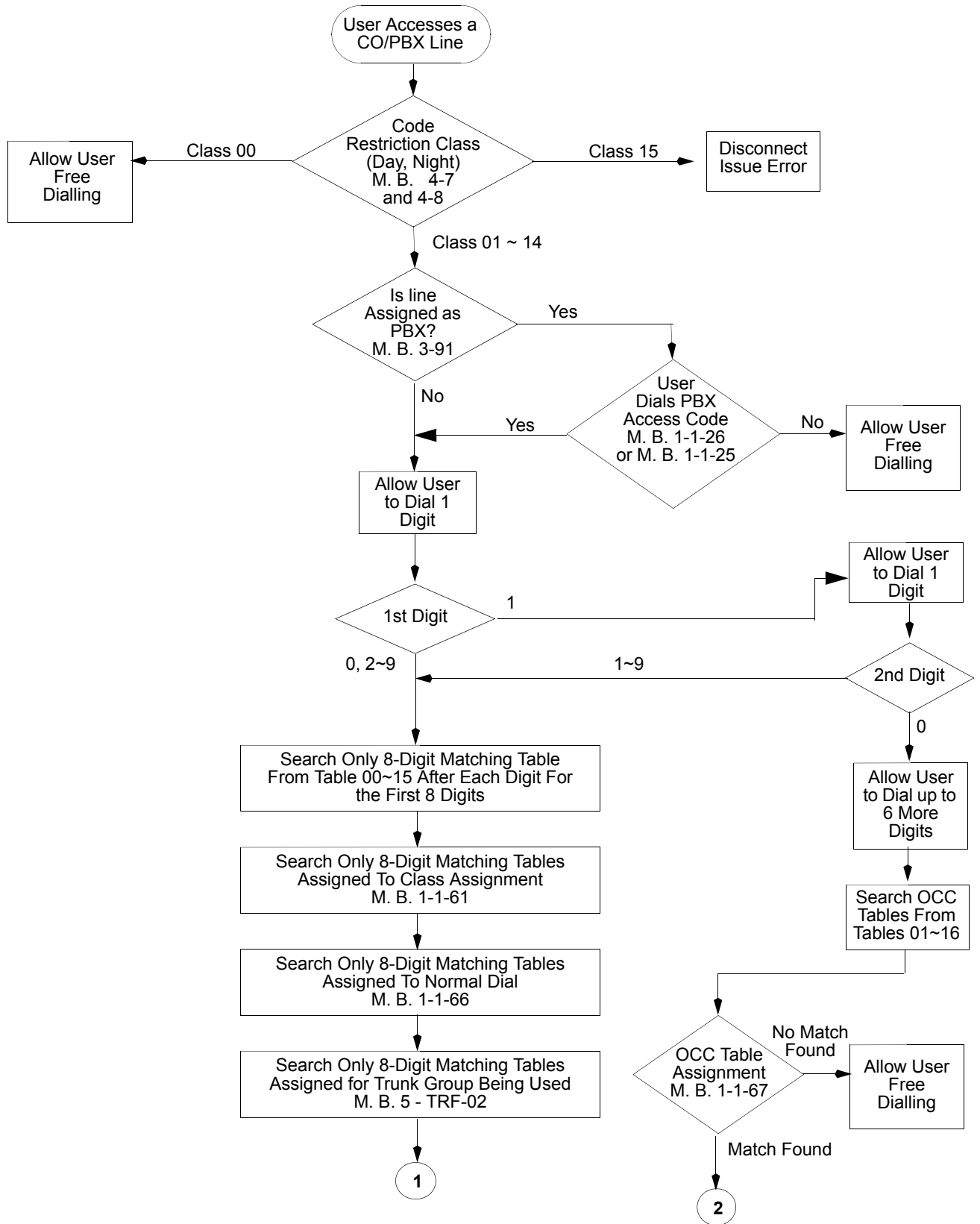

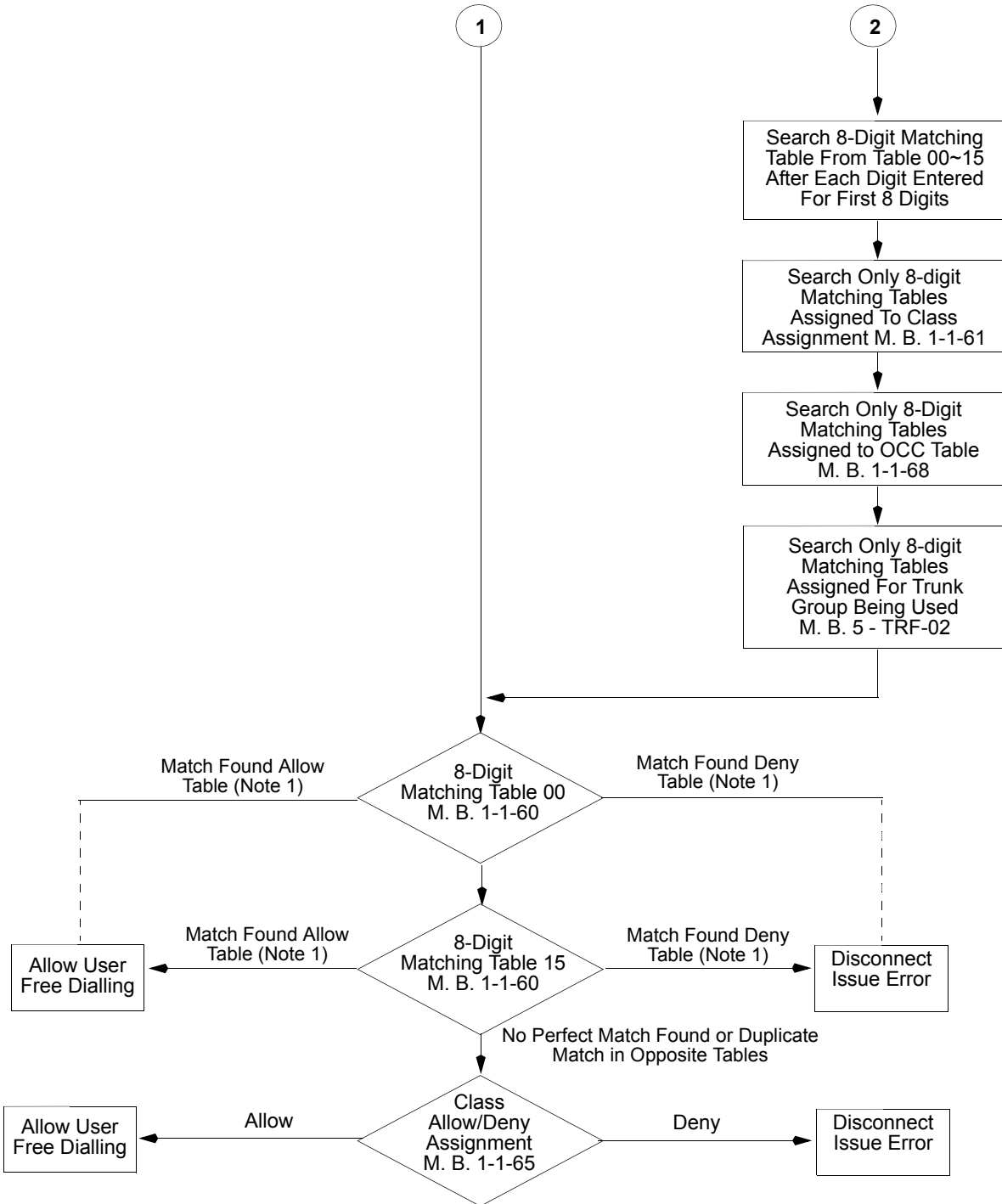

1. Tables are assigned as Allow or Deny in the 8-Digit Matching Table to Class Assignment (Memory Block 1-1-61).
2. If the interdigit time duration of the dialling party exceeds 10 seconds while the Code Restriction Tables are being searched, the system automatically drops the call.

# SECTION 7

## CHARACTER CODE TABLES

The character code tables are used when entering some of the functions provided with the Xen system.

For Key Pad entry refer to *7.1 Dial Pad Character Assignment*.

# N

Codes 166~221 and 250~252 are used for Japanese characters only.

### 7.1 Dial Pad Character Assignment

Refer to the applicable table and procedure example.

**Table 1-4:** System Data Input

Press	1	2	3	4	5	6	7	8	9	0	Redial
<b>1st</b>	1	A	D	G	J	M	P	T	W	0	*
<b>2nd</b>	@	B	E	H	K	N	Q	U	X	!	+
<b>3rd</b>	[	C	F	I	L	O	R	V	Y	"	,
<b>4th</b>	¥	a	d	g	j	m	S	t	Z	#	-
<b>5th</b>	]	b	e	h	k	n	p	u	w	\$	.
<b>6th</b>	^	c	f	i	l	o	q	v	x	%	/
<b>7th</b>		2	3	4	5	6	r	8	y	&	:
<b>8th</b>	'	To A	To D	To G	To J	To M	s	To T	z	'	;
<b>9th</b>	{						7		9	(	<
<b>10th</b>							To P		To W	)	=
<b>11th</b>	}								To 0		>
<b>12th</b>	È										?
<b>13th</b>	Á										To *
<b>14th</b>	To 1										
<b>*</b>	Used to move cursor to left.										
<b>#</b>	Used to move cursor to right.										
<b>Hold</b>	Space (MB3-00)    Data Clear (except MB3-00)										

7.1.1 Trunk name or Number Assignment Example  
(DNIS assignment uses this character dial pad.)









1. Enter Program Mode.  
Display shows PROGRAM MODE.
2. Press LK3.  
Display shows 01/\_
3. Press LK2  
Display still shows 01/\_
4. Press    
Display shows 01/N\_.
5. Press    
Display shows 01/NE\_.
6. Press     
Display shows 01/NEC\_.
7. Press   
Display shows 01/02:OUT&IN

Table 1-5: Speed Dial Name Input

Press	1	2	3	4	5	6	7	8	9	0	*	#
1st	1	A	D	G	J	M	P	T	W	0	*	Set
2nd	@	B	E	H	K	N	Q	U	X	!	+	Space
3rd	[	C	F	I	L	O	R	V	Y	"	,	To Set
4th		a	d	g	j	m	S	t	Z	#	-	
5th	]	b	e	h	k	n	p	u	w	\$	.	
6th	^	c	f	i	l	o	q	v	x	%	/	
7th	¥	2	3	4	5	6	r	8	y	&	:	
8th	'	To A	To D	To G	To J	To M	s	To T	z	'	;	
9th	{						7		9	(	<	
10th							To P		To W	)	=	
11th	}									To 0	>	
12th	È										?	
13th	Á										To *	
14th	To 1											
Conf	Clear and 1 character back from the cursor.											

## 7.1.1 Enter Speed Dial Name

1. Press inactive **Feature**  
Display is blank.
2. Press **Redial**  
Display shows \_:
3. Press **0** **0**  
Display shows 00:\_
4. Press **0**  
Display shows 00:0:\_
5. Press **1** **2** **3** **4** **5**  
Display shows 00:0:12345\_.
6. Press **Hold**  
Display shows 00=\_
7. Press **6**  
Display shows 00=M\_
8. Press **6**  
Display shows 00=N\_.
9. Press **3**  
Display shows 00=ND\_.
10. Press **3**  
Display shows 00=NE\_.
11. Press **2**  
Display shows 00=NEA\_.
12. Press **2**  
Display shows 00=NEB\_.
13. Press **2**  
Display shows 00=NEC\_.
14. Press **#**  
Display shows 00=NEC\_.
15. Press **2**  
Display shows 00=NECA\_.
16. Press **6**  
Display shows 00=NECAM\_.
17. Press **Feature**.

## SECTION 8

### DISPLAY ABBREVIATIONS

Abbreviations found in the display are defined in below.

**Table 1-6:** Abbreviations Used in Multiline Terminal Displays

ADD/DEL	Addition/Deletion	ESP	External Speaker
AL	All	FWDG	Forwarding
ALM	Alarm	FLSH	Flash
ANS	Answer	GUARD	Outgoing Guard Time
ANSWR	Answer	H	High
ASSGN	Assignment	HR	Hour
AUT	Automatic	ICM	Intercom (Extension)
AUTANS	Autoanswer	IMDT	Immediate
BLANK	Service Class	IN	Incoming
BNCE	Bounce	INC	Incoming Signal Detection Time Assignment
BTN	Button	INDV	Individual
CAL	Call	INTRPT	Interruption
CANCLD	Cancelled	L	Low
CKT	Circuit	LCD	Liquid Crystal Display
CNF	Confirmation	LN	LIne
CL	Class	LOOP	Loop Off-Guard Assignment
CLD	CO Line Display	LNR/SPD	Last Number/Speed Dial
CLR	Clear	M	Medium
CLS	Class	MAN	Manual
CONN	Connection	MF	Dual-Tone Multifrequency (DTMF)
DESG	Designation	MIN	Minimum
DGT	Digit	MOH	Music On Hold
DISP	Display	MSTR	Master
DISTM	Disconnection Recognition Time	NBR	Number
DIVERT	Diversion	NT	Night Mode
DLY	Delay Signal Time	OUT	Outgoing
DP	Dial Pulse	OG TM	Outgoing Time OUt Assignment
DSS	Direct Station Selection	OV	Over



**Table 1-6:** Abbreviations Used in Multiline Terminal Displays (Continued)

DY	Day Mode	RNGTONE	Ringing Tone
PAD AT	PAD Pattern A Transmission Assignment	RT	Route
PAD AR	PAD Pattern A Receiving Assignment	RT ADV	Route Advance Block
PAD BT	PAD Pattern B Transmission Assignment	RVS	Reversal
PAD BR	PAD Pattern B Receiving Assignment	SDT	Second Dial Tone Assignment
PRE	Prepause Time Selection	SEND	Transmission
PBR	Pushbutton Signal Receiver	SEL	Selection
PBX	Private Branch Exchange	SLT	Single Line Telephone
PRNT	Print	SPD	Speed Dial
PTRN	Pattern	ST	Start
PV	Tie Line	TEL	Telephone
PVT	Tie Line	TERM	Terminating
PWRFAIL	Power Failure	TMR	Timer
RCV	Receiving	TMD	Timed
RCVR	Receiver	TRNS	Transfer
RES	Restriction	TRK	Trunk
RINGTONE	Ringing Tone	TRK GP	Trunk Group
RLY	Relay	WDSD	Wink/Delay Signal Detection Timeout

THIS PAGE INTENTIONALLY LEFT BLANK

# Guide to Feature Programming

## SECTION 1 GENERAL INFORMATION

This chapter provides a roadmap for programming the features for the Xen IPK systems. The Programming Xen IPK System Guide Tables provide information helpful to the technician when programming the systems.







## SECTION 2 PROGRAMMING GUIDE TABLES

The tables provided in this section are useful as a quick reference when programming the Xen system. The tables are listed alphabetically by feature name. For each feature, information for accessing the programming blocks using PC Programming or Multiline Terminal programming is listed. The Keyboard Shortcut is used to access the Memory Blocks via PC Programming. The Memory Block Number is used to access the Memory Block via Multiline Terminal Programming.











All Memory Blocks associated with the feature are listed in the table. Some Memory Blocks must be programmed before a feature can be used. Other Memory Blocks are optional, but can affect how the feature operates. The Memory Blocks that must be programmed are indicated with the following symbols in the table.

- \* When the system is at default this Memory Block must be programmed for the feature to be used.
- \*\* At least one of the listed Memory Blocks must be programmed before the feature can be used.





**Account Code Entry**

Menu Access Keyboard Shortcut	System Data Name	Memory Block
 +BT	Start Timer Selection	1-1-05
 +BA	Access Code (1-, 2-, or 3-Digit Assignment)	1-1-46/47/48
 +AS	* Printer Connected Selection	1-5-13
 +AS	SMDR Valid Call Timer Assignment	1-5-25
 +BTS	Class of Service (Station) Feature Selection 2	1-8-08 (Pg. 3, LK6)
 +BTT	* Station to Class of Service Feature Assignment	4-17



**Account Code Forced/Unverified**

Menu Access Keyboard Shortcut	System Data Name	Memory Block
 +BA	** Access Code (1-, 2-, or 3-Digit) Assignment	1-1-46/47/48
 +BTS	Class of Service (Attendant) Feature Selection 1	1-8-07
 +BTS	* Class of Service (Station) Feature Selection 2	1-8-08 (Pg. 6, LK3)
 +BF	Forced Account Code Length Assignment	1-8-27
 +BTT	Station to Class of Service Feature Assignment	4-17
 +AC	8 Digit Matching Table Assignment	1-1-60
 +AC	8 Digit Matching Table to Class Assignment'	1-1-61
 +AC	Code Restriction Class Assignment (Day Mode)	4-07
 +AC	Code Restriction Class Assignment (Night Mode)	4-08
 +AC	Code Restriction Class Assignment (FVA Restricted Tel/ Day Mode)	4-64
 +AC	Code Restriction Class Assignment (FVA Restricted Tel/ Night Mode)	4-65









**Account Code Forced/Verified**

Menu Access Keyboard Shortcut	System Data Name	Memory Block
 +BA	** Access Code (1-, 2-, or 3-Digit) Assignment	1-1-46/47/48
 +BTS	Class of Service (Attendant) Feature Selection 1	1-8-07
 +BTS	* Class of Service (Station) Feature Selection 2	1-8-08 (Pg. 5, LK1)
 +BF	Forced Account Code Length Assignment	1-8-27
 +BTT	Station to Class of Service Feature Assignment	4-17





**Add-On Conference**

Menu Access Keyboard Shortcut	System Data Name	Memory Block
 +BN	Trunk to Tenant Assignment	2-01
 +BCT	Trunk to Trunk Transfer Yes/No Selection	3-03
 +BTT	CO/PBX Ring Assignment (Day Mode)	4-01

**All Call Page**

Menu Access Keyboard Shortcut	System Data Name	Memory Block
 +BA	Access Code (1-, 2-, or 3-Digit) Assignment	1-1-46/47/48
 +BP	Internal Paging Timeout Selection	1-2-00
 +BP	Internal Paging Alert Tone Selection	1-2-25
 +BP	External Speaker Connection Selection	1-7-02
 +BP	External Paging Alert Tone Selection	1-7-03
 +BP	External Paging Timeout Selection	1-7-06
 +BTT	Receiving Internal/All Call Page Selection	4-31
 +BTM	Internal Zone Paging Selection	4-93







**Alphanumeric Display**

Menu Access Keyboard Shortcut	System Data Name	Memory Block
 +BE	Speed Dial Number/Name Display Selection	1-1-33
 +BI	Customised Message 1~10 Assignment	1-2-09~18
 +BCT	* Trunk Name/Number Assignment	3-00
 +BTT	* Station Name Assignment	4-18
 +BTM	Multilingual LCD Indication Selection	4-28





**Ancillary Device Connection**

Menu Access Keyboard Shortcut	System Data Name	Memory Block
 +BTM	ADA(2) Ring Mode Assignment	4-39





**Answer Hold**

Menu Access Keyboard Shortcut	System Data Name	Memory Block
 +BT	Hold Recall Timer Selection (Non-Exclusive Hold)	1-1-03
 +BTM	* Off-Hook Ringing Selection	4-51
 +BN	Trunk to Tenant Assignment	2-01
 +BTT	* CO/PBX Ring Assignment (Day Mode)	4-01
 +BTT	* CO/PBX Ring Assignment (Night Mode)	4-02
 +BTT	* CO/PBX Answer Key Operation without Ringing (Day Mode)	4-52
 +BTT	* CO/PBX Answer Key Operation without Ringing (Night Mode)	4-53



**Answer Key**

Menu Access Keyboard Shortcut	System Data Name	Memory Block
 +BTM	* Off-Hook Ringing Selection	4-51
 +BN	Trunk to Tenant Assignment	2-01
 +BCT	DIT Assignment	3-42
 +BCT	ANA Assignment	3-43







**Answer Key (Continued)**

Menu Access Keyboard Shortcut	System Data Name	Memory Block
 +BTT	* CO/PBX Ring Assignment (Day Mode)	4-01
 +BTT	* CO/PBX Ring Assignment (Night Mode)	4-02
 +BTM	Ringing Line Preference Selection	4-11
 +BTT	* CO/PBX Answer Key Operation without Ringing (Day Mode)	4-52
 +BTT	* CO/PBX Answer Key Operation without Ringing (Night Mode)	4-53





**Assigned Night Answer (ANA)**

Menu Access Keyboard Shortcut	System Data Name	Memory Block
 +BCT	* ANA Assignment	3-43
 +BCT	DIT Delay Answer Timer Selection	3-61
 +BCT	DIT Night Mode Delay Answer Enable (ANA)	3-64



**Attendant Add-On Console**

Menu Access Keyboard Shortcut	System Data Name	Memory Block
 +BTD	* Attendant Add-On Console to Telephone Port Assignment	1-6-01
 +BTD	* Attendant Add-On Console Key Selection	1-6-05
 +BTT	CO/PBX Ring Assignment (Day Mode)	4-01
 +BTT	CO/PBX Ring Assignment (Night Mode)	4-02
 +BTM	Line Key Selection for Telephone Mode	4-12
 +BTT	Prime Line/Hot Line Assignment	4-23
 +BS	Telephone Type Assignment	7-2





**Attendant Camp-On**

Menu Access Keyboard Shortcut	System Data Name	Memory Block
 +BTS	System Transfer/Camp-On Selection	1-1-11
 +BT	Attendant Add-On Console Transfer/Camp-On Recall Timer Selection	1-1-64
 +BTS	Class of Service (Station) Feature Selection 2	1-8-08
 +BTT	SLT Data Line Security Assignment	4-90





**Attendant Positions**

Menu Access Keyboard Shortcut	System Data Name	Memory Block
 +BTD	* Attendant Add-On Console to Telephone Port Assignment	1-6-01
 +BTS	* Class of Service (Attendant) Feature Selection 1	1-8-07
 +BTT	* Station to Class of Service Feature Assignment	4-17

**Attendant Station Outgoing Lockout**

Menu Access Keyboard Shortcut	System Data Name	Memory Block
 +AC	Code Restriction Class Assignment when Lockout is Set	1-1-70
 +BTD	* Attendant Add-On Console Key Selection	1-6-05
 +AC	Code Restriction Class Assignment (Day Mode)	4-07
 +AC	Code Restriction Class Assignment (Night Mode)	4-08

**Attendant Transfer**





Menu Access Keyboard Shortcut	System Data Name	Memory Block
 +BTS	* System Transfer/Camp-On Selection	1-1-11
 +BCS	CO Transfer Ring Pattern Selection	1-1-13
 +BCS	CO Transfer Ring Tone Selection	1-1-14
 +BT	Attendant Add-On Console Transfer/Camp-On Recall Timer Selection	1-1-64
 +BTD	Attendant Add-On Console Key Selection	1-6-05





## Automated Attendant

Menu Access Keyboard Shortcut	System Data Name	Memory Block
 +BA	* Access Code (1-, 2-, or 3-Digit) Assignment	1-1-46/47/48 (Item 501)
 +AU	Automated Attendant Transfer Ring Pattern	1-1-54
 +BA	Specified Station Access Code Assignment	1-2-08
 +AU	Automated Attendant First Digit PBR Release Timer Selection	1-4-01
 +AU	Automated Attendant Transfer Delayed Ringing Time Selection	1-4-02
 +AU	Automated Attendant No Answer Disconnect Time Selection	1-4-03
 +AT	Tandem Transfer SMDR Print Extension Assignment	1-4-04
 +AU	Automated Attendant PBR Timeout Response Selection	1-4-08
 +AU	Automated Attendant PBR Start Time Selection	1-4-09
 +AU	* Automated Attendant Message Day/Night Mode Selection	1-4-11
 +AU	Automated Attendant Message to Tenant Assignment	1-4-12
 +AU	Automated Attendant Answer Delay Time Assignment	1-4-13
 +AU	Automated Attendant Message Access Code (1-Digit) Assignment	1-4-14
 +AU	Automated Attendant Message Access Code (2-Digit) Assignment	1-4-15
 +AU	Automated Attendant Message Repeat Selection	1-4-16
 +AU	Automated Attendant Delay Announcement Hold Tone Selection	1-4-17
 +BTI	* SLT or Automated Attendant/DISA to PBR Selection	1-8-01
 +AU	Automated Attendant Function Selection	3-59
 +AU	PBR Receive Level Assignment for Automated Attendant/DISA	1-8-02
 +BTS	Class of Service (Attendant) Feature Selection 1	1-8-07 (Pg. 1, LK8 and Pg. 2, LK7)
 +BTS	Class of Service (Station) Feature Selection 2	1-8-08 (Pg. 2, LK6)
 +AR	VRS Message Recording Time Selection	1-8-12
 +AR	* VRS Message Function Assignment	1-8-13













**Automated Attendant**

Menu Access Keyboard Shortcut	System Data Name	Memory Block
 +BI	Tone Assignment	1-8-15 (Table 1)
 +BCT	* Trunk Incoming Answer Mode Selection	3-05
 +AU	Automated Attendant Message to Trunk Selection	3-38
 +BTT	CO/PBX Ring Assignment (Day Mode)	4-01
 +BTT	CO/PBX Ring Assignment (Night Mode)	4-02





**Automatic Callback**

Menu Access Keyboard Shortcut	System Data Name	Memory Block
 +BT	Automatic Callback Release Timer Selection	1-2-02
 +BA	Intercom Feature Access Code Assignment	1-2-24
 +BTS	Class of Service (Station) Feature Selection 2	1-8-08

**Automatic Call Distribution**













Menu Access Keyboard Shortcut	System Data Name	Memory Block
 +BA	* Access Code (1-, 2-, or 3-Digit) Assignment	1-1-46/47/48 (Items 031, 032, and 040)
 +BT	Call Forward No Answer Timer Selection	1-2-22
 +BTS	Class of Service (Station) Feature Selection 2	1-8-08 (Pg. 1, LK1, LK4, and LK5)
 +AA	* ACD/UCD Group Agent Assignment	1-8-25
 +AA	* ACD/UCD Group Pilot Number Assignment	1-12-00
 +AA	ACD/UCD Group Overflow Destination Assignment	1-12-01
 +AA	ACD/UCD Overflow Timer Selection	1-12-02
 +BCT	* DIT Assignment	3-42
 +BCT	* ANA Assignment	3-43
 +BCT	DIT Delay Answer Timer Selection	3-61
 +BCT	DIT Holiday Mode Enable	3-63
 +BCT	DIT Night Mode Delay Answer Enable (ANA)	3-64

**Automatic Call Distribution (Continued)**







Menu Access Keyboard Shortcut	System Data Name	Memory Block
 +BCT	Polarity Reverse Selection	3-90
 +BTM	Line Key Selection for Telephone Mode	4-12
 +BS	Card Interface Slot Assignment	7-1
 +BS	MIF (ACD) Assignment	7-3-00

Refer to *Delay Announcement* on page 2566.





**Account Carrier Routing**

Menu Access Keyboard Shortcut	System Data Name	Memory Block
 +BA	Access Code (1-, 2-, 03 or 3-Digit Assignment)	1-1-46/47/48
 +BCT	Trunk to Trunk Group Assignment	3-03
 +BCT	Trunk Type Selection	3-91
 +BTT	LCR/ACR Class Selection	4-40
 +BS	Card Interface Slot Assignment	7-1
 +AO	ACR Feature Allow/Deny Selection	1-14-00
 +AO	ACR Dialling Assignment	1-14-01
 +AO	ACR Dialed Number Dial Allow/Deny Selection	1-14-02
 +AO	ACR Route Table Number Assignment	1-14-03
 +AO	ACR Trunk Group to Route Number Assignment	1-14-04
 +AO	ACR Digit Delete Assignment	1-14-05
 +AO	ACR Digit Add Assignment	1-14-06





**Automatic Day/Night Mode Switching**

Menu Access Keyboard Shortcut	System Data Name	Memory Block
 +BT	* Automatic Day/Night Mode Switching Time Assignment	1-1-27
 +BT	Automatic Day/Night Mode by Day of Week Selection	1-1-32
 +BTS	Class of Service (Attendant) Feature Selection 1	1-8-07
 +BTT	CO/PBX Ring Assignment (Day Mode)	4-01
 +BTT	CO/PBX Ring Assignment (Night Mode)	4-02
 +AC	Code Restriction Class Assignment (Day Mode)	4-07
 +AC	Code Restriction Class Assignment (Night Mode)	4-08

**Automatic Hold**

Menu Access Keyboard Shortcut	System Data Name	Memory Block
 +BT	Hold Recall Timer Selection (Non-Exclusive Hold)	1-1-03
 +BTD	Attendant Add-On Console to Telephone Port Assignment	1-6-01
 +BTD	Attendant Add-On Console Key Selection	1-6-05
 +BN	Line Key Selection for Tenant Mode	2-06
 +BTM	Line Key Selection for Telephone Mode	4-12

**Automatic Outgoing CO/PBX Line Selection**









Menu Access Keyboard Shortcut	System Data Name	Memory Block
 +BA	* Access Code (1-, 2-, or 3-Digit Assignment)	1-1-46/47/48
 +BN	Line Key Selection Tenant Mode	2-06
 +BTT	* Automatic Outgoing CO/PBX Line Selection	4-05
 +BTM	Line Key Selection Tel Mode	4-12
 +BTT	Prime Line/Hotline Assignment	4-23

**Automatic Redial**

Menu Access Keyboard Shortcut	System Data Name	Memory Block
 +BT	Automatic Redial Time Selection	1-1-04

Menu Access Keyboard Shortcut	System Data Name	Memory Block
 +BCT	Polarity Reverse Selection	3-39





**Automatic Trunk-to-Trunk Transfer**

Menu Access Keyboard Shortcut	System Data Name	Memory Block
 +AT	Tandem Transfer Automatic Disconnect Timer Selection	1-4-00
 +AT	Automatic Tandem Trunk by Night Mode Selection	1-4-05
 +BTS	Class of Service (Attendant) Feature Selection 1	1-8-07
 +BCT	* Trunk-to-Trunk Transfer Yes/No Selection	3-04
 +BCT	* Trunk Incoming Answer Mode Selection	3-05
 +AT	* Automatic Tandem Trunk Assignment	3-06
 +BCT	Automatic Release Signal Detection Selection	3-39
 +BCT	Polarity Reversal Selection	3-90

**Background Music Port Assignment**

Menu Access Keyboard Shortcut	System Data Name	Memory Block
 +BCS	BGM Port Assignment	1-1-79





**Barge-In**

Menu Access Keyboard Shortcut	System Data Name	Memory Block
 +BT	Start Timer Selection	1-1-05
 +BCS	Private Line Assignment	1-1-29
 +BTS	* Class of Service (Station) Feature Selection 2	1-8-08
 +BN	Trunk to Tenant Assignment	2-01





**Barge-In (Continued)**

Menu Access Keyboard Shortcut	System Data Name	Memory Block
 +BTT	SLT Data Line Security Assignment	4-90





**Busy Lamp Field on Multiline Terminals**

Menu Access Keyboard Shortcut	System Data Name	Memory Block
 +BE	Speed Dial Buffer Allocation	1-1-35
 +BN	Line Key Selection	2-05
 +BN	Line Key Selection for Tenant Mode	2-06
 +BTM	Line Key Selection for Telephone Mode	4-12











**Call Alert Notification**

Menu Access Keyboard Shortcut	System Data Name	Memory Block
 +BT	Call Forward No Answer Timer Selection	1-2-22
 +BTT	Call Forward – Busy Immediately/Delay Selection	4-42
 +BTT	SLT Data Line Security Assignment	4-90
 +BTS	Class of Service (Station) Feature Selection 2	1-8-08 (Pg3, LK8)



**Call Appearance Keys**

Menu Access Keyboard Shortcut	System Data Name	Memory Block
 +BN	* Line Key Selection	2-05
 +BN	Line Key Selection for Tenant Mode	2-06
 +BTM	* Line Key Selection for Telephone Mode	4-12
 +BTT	* Station to Call Appearance Block Assignment	4-43







## Call Arrival Keys

Menu Access Keyboard Shortcut	System Data Name	Memory Block
 +BA	Access Code (1-, 2-, or 3-Digit) Assignment	1-1-46/47/48
 +BK	* Call Arrival Key Block Assignment	1-2-04
 +BTD	Attendant Add-On Console Key Selection	1-6-05
 +BN	Line Key Selection	2-05
 +FZ	*Station Number Assignment	4-10
 +BN	Line Key Selection for Tenant Mode	2-06
 +BTM	* Line Key Selection for Telephone Mode	4-12
 +BTM	* Extension Line Key Ring Assignment (Day Mode)	4-37
 +BTM	* Extension Line Key Ring Assignment (Night Mode)	4-38
 +BTM	SIE/CAR Ringing Line Preference Selection	4-41
 +BTT	Station to Call Appearance Block Assignment	4-43









## Callback Request

Menu Access Keyboard Shortcut	System Data Name	Memory Block
 +BA	Intercom Feature Access Code Assignment	1-2-24
 +BTS	Class of Service (Station) Feature Selection 2	1-8-08
 +BTT	Station to Class of Service Feature Assignment	4-17







## Caller ID Indication

Menu Access Keyboard Shortcut	System Data Name	Memory Block
 +AI	** Caller ID Display Assignment for System Mode	1-1-78
 +BTS	* Class of Service (Station) Feature Selection 2	1-8-08 (Pg. 4, LK3 and LK4)
 +BN	Line Key Selection for Tenant Mode	2-06
 +BCT	** DIT Assignment	3-42
 +BCT	** ANA Assignment	3-43
 +AI	** Caller ID Display Assignment for CO/PBX Line	3-44
 +AI	Caller Name Indication Selection	3-53







**Caller ID Indication (Continued)**

Menu Access Keyboard Shortcut	System Data Name	Memory Block
 +BTT	CO/PBX Ring Assignment (Day Mode)	4-01
 +BTT	CO/PBX Ring Assignment (Night Mode)	4-02
 +BTM	Line Key Selection for Telephone Mode	4-12
 +BTM	Extension Line Key Ring Assignment (Day Mode)	4-37
 +BTM	Extension Line Key Ring Assignment (Night Mode)	4-38
 +AI	Caller ID Outgoing CO Selection	4-44
 +BS	Card Interface Slot Assignment	7-1
 +BS	MIF (Caller ID) Assignment	7-3-04

**Call Forward – All Calls**









Menu Access Keyboard Shortcut	System Data Name	Memory Block
 +BA	Access Code (1-, 2-, or 3-Digit) Assignment	1-1-46/47/48
 +BTS	Class of Service (Attendant) Feature Selection 1	1-8-07
 +BTS	Class of Service (Station) Feature Selection 2	1-8-08
 +BN	Line Key Selection	2-05
 +BN	Line Key Selection for Tenant Mode	2-06
 +BTM	Line Key Selection for Telephone Mode	4-12
 +BTT	Station to Class of Service Feature Assignment	4-17

**Call Forward – Busy/No Answer**



Menu Access Keyboard Shortcut	System Data Name	Memory Block
 +BA	Access Code (1-, 2-, 3-Digit) Assignment	1-1-46/47/48
 +BTS	Class of Service (Attendant) Feature Selection 1	1-8-07
 +BTS	Class of Service (Station) Feature Selection 2	1-8-08
 +BN	Line Key Selection	2-05
 +BN	Line Key Selection for Tenant Mode	2-06
 +BTM	Line Key Selection for Telephone Mode	4-12
 +BTT	Station to Class of Service Feature Assignment	4-17



**Call Forward – Off-Premise (MLT/SLT & CAR)**

Menu Access Keyboard Shortcut	System Data Name	Memory Block
 +BA	Access Code (1-, 2-, or 3-Digit) Assignment	1-1-46/47/48
 +AT	Tandem Transfer Automatic Disconnect Timer Selection	1-4-00
 +BTS	*Class of Service (Attendant) Feature Selection 1	1-8-07 (Pg. 2, LK2/LK3)
 +BTS	*Class of Service (Station) Feature Selection 2	1-8-08 (Pg. 5, LK4)
 +BN	Line Key Selection	2-05
 +BN	Line Key Selection for Tenant Mode	2-06
 +BCT	* Trunk-to-Trunk Transfer Yes/No Selection	3-04
 +BTM	Line Key Selection for Telephone Mode	4-12
 +BTT	Station to Class of Service Feature Assignment	4-17



**Call Park – System**

Menu Access Keyboard Shortcut	System Data Name	Memory Block
 +BA	Access Code (1-, 2-, or 3-Digit) Assignment	1-1-46/47/48
 +BT	System Call Park Recall Time Selection	1-2-23



**Call Pickup Direct**

Menu Access Keyboard Shortcut	System Data Name	Memory Block
 +BA	Access Code (1-, 2-, or 3-Digit) Assignment	1-1-46/47/48 (Item 042)

















**Call Pickup Tenant**

Menu Access Keyboard Shortcut	System Data Name	Memory Block
 +BA	Access Code (1-, 2-, or 3-Digit) Assignment	1-1-46/47/48
 +BN	Trunk to Tenant Assignment	2-01
 +BTT	Telephone to Tenant Assignment	4-09





**Call Pickup Group**

Menu Access Keyboard Shortcut	System Data Name	Memory Block
 +BA	Access Code (1-, 2-, or 3-Digit) Assignment	1-1-46/47/48
 +BTC	Call Pickup Group Assignment	1-2-31



**Centralised Voice Mail**

Menu Access Keyboard Shortcut	System Data Name	Memory Block
 +BA	Access Code (1-, 2- or 3-Digit) Assignment	1-1-46/47/48
 +BCS	Networking Trunk Group/Route Advance Assignment	1-1-49
 +BCS	CO/PBX Outgoing Digit Add Assignment	1-1-50
 +AV	Voice Mail Digit Add Assignment	1-3-07
 +AV	Voice Mail DTMF Delay Time Selection	1-3-08
 +AV	Voice Mail Disconnect Time Selection	1-3-09
 +AV	Voice Mail DTMF Duration/Interdigit Time Selection	1-3-10
 +BK	Call Arrival Key Block Assignment	1-2-04
 +BTS	Class of Service (Station) Feature Selection 2	1-8-08
 +AV	Voice Mail Quick Transfer Master Hunt Number	1-8-26
 +AV	CAR for Voice Mail Message Notice Assignment	1-8-47
 +BCT	Trunk to Trunk Group Assignment	3-03
 +BCT	Trunk Type Selection	3-91
 +BCT	Trunk (Installed, DP/DTMF) Selection	3-92
 +BTT	Intercom Master Hunt Number Selection	4-14
 +BTT	Intercom Master Hunt Number Forward Assignment	4-15
 +BTT	Station to Class of Service Feature Assignment	4-17

### Centralised Voice Mail

Menu Access Keyboard Shortcut	System Data Name	Memory Block
 +BTI	Voice Mail/SLT Selection	4-35
 +ALN	Tie Line Networking Tandem Connection Assignment	5-01
 +BS	Card Interface Slot Assignment	7-1
 +BS	Telephone Type Assignment	7-2

### Class of Service









Menu Access Keyboard Shortcut	System Data Name	Memory Block
 +BTS	Class of Service (Attendant) Feature Selection 1	1-8-07
 +BTS	Class of Service (Station) Feature Selection 2	1-8-08
 +BTT	Station to Class of Service Feature Assignment	4-17

### Clock/Calendar Display

Menu Access Keyboard Shortcut	System Data Name	Memory Block
 +BT	* Time Display (12h/24h) Selection	1-8-04

Note: The Clock/Calendar can only be set from Ports 01 and 02.

### Code Restriction

Menu Access Keyboard Shortcut	System Data Name	Memory Block
 +AC	System Speed Dial Restriction by Tenant	1-1-18
 +BO	Line Selection Using Outgoing	1-1-19
 +BA	PBX/CTX Access Code Assignment I	1-1-24
 +BA	PBX/CTX Access Code Assignment II	1-1-25
 +BA	Access Code (1-Digit) Assignment	1-1-46
 +BA	Access Code (2-Digit) Assignment	1-1-47
 +BA	Access Code (3-Digit) Assignment	1-1-48
 +AC	8-Digit Matching Table Assignment	1-1-60
 +AC	8-Digit Matching Table to Class Assignment	1-1-61

**Code Restriction (Continued)**

Menu Access Keyboard Shortcut	System Data Name	Memory Block
 +AC	System Speed Dial Override by Class Selection	1-1-62
 +AC	Code Restriction Class Allow/Deny Selection	1-1-65
 +AC	8-Digit Matching Table to Normal Dial Assignment	1-1-66
 +AC	OCC Table Assignment	1-1-67
 +AC	8-Digit Matching Table to OCC Table Assignment	1-1-68
 +AC	Tie Line Code Restriction Assignment	1-1-69
 +AC	Code Restriction Class Assignment when Lockout is Set	1-1-70
 +AS	Outgoing Mode Selection	1-5-23
 +BTS	Class of Service (Attendant	1-8-07
 +BTS	Class of Service (Station)	1-8-08
 +BD	DISA ID Code Assignment	1-9-00
 +BD	DISA Password Effect/Invalid Selection	1-9-02
 +BO	ID Restriction Class Assignment (Day Mode)	1-9-03
 +BO	ID Restriction Class Assignment (Night Mode)	1-9-04
 +BN	Trunk to Tenant Assignment	2-01
 +BCT	Trunk-to-Trunk Group Assignment	3-03
 +BCT	Trunk Type Selection	3-91
 +AC	Code Restriction Class Assignment (Day Mode)	4-07
 +AC	* Code Restriction Class Assignment (Night Mode)	4-08
 +BTT	Telephone to Tenant Assignment	4-09
 +BTT	Station to Class of Service Feature Assignment	4-17
 +BTT	Trunk Outgoing Restriction	4-19
 +BD	DISA ID Number Station Assignment	4-26
 +BO	ID Outgoing Restriction Selection	4-27
 +BTT	Trunk Digit Restriction	4-32
 +AC	8-Digit Matching Table to Trunk Group Assignment	5-02
 +AC	OCC Table to Trunk Group Assignment	5-03

Refer to *Code Restriction on page 2563*.

### CO/PBX Tie Line Digit Restriction



Menu Access Keyboard Shortcut	System Data Name	Memory Block
 +BTT	Trunk Digit Restriction	4-32

Refer to *E & M Tie Lines (4-Wire)* on page 2573 and to *Code Restriction* on page 1-563.

### Cordless Telephone Connection

Menu Access Keyboard Shortcut	System Data Name	Memory Block
 +BTM	APR Ring Mode Assignment	4-39









### Customised Message

Menu Access Keyboard Shortcut	System Data Name	Memory Block
 +BI	Customised Message 1~10 Assignment	1-2-09~18
 +BTS	Class of Service (Station) Feature Selection 2	1-8-08
 +BTT	Station to Class of Service Feature Assignment	4-17

### Data Line Security

Menu Access Keyboard Shortcut	System Data Name	Memory Block
 +BTT	* SLT Data Line Security Assignment	4-90

## Delay Announcement

Menu Access Keyboard Shortcut	System Data Name	Memory Block
 +BA	* Access Code (1-, 2-, 3-Digit) Assignment	1-1-46/47/48 (Item 501)
 +AR	First Delay Announcement Start Time Selection	1-1-71
 +AR	First Delay Announcement Repeat Selection	1-1-72
 +AR	First to Second Delay Announcement Interval Time Selection	1-1-73
 +AR	Second Delay Announcement Repeat Selection	1-1-74
 +AR	Second Delay Announcement Repeat Interval Time Selection	1-1-75
 +AR	VRS Message Recording Time Selection	1-8-12
 +AR	* VRS Message Function Assignment	1-8-13
 +AR	* Delay Announcement Assignment	3-41

Note 1: To record the Delay Announcements:

First Announcement – Dial Access Code ⇨ Dial ① ⇨ Dial ③<sub>del</sub> ⇨ Dial ①

(Access Codes are set in Memory Blocks 1-1-46, 1-1-47, or 1-1-48)







Second Announcement – Dial Access Code ⇨ Dial ① ⇨ Dial ③<sub>del</sub> ⇨ Dial ②<sub>del</sub>

(Access Codes are set in Memory Blocks 1-1-46, 1-1-47, or 1-1-48)





Note 2: Requires an MIFA-U( ) ETU or MIFM-U( ) ETU before the Memory Block can be programmed.

Note 3: Incoming analogue trunks must provide Reversal On Idle and Reversal On Answer signalling for correct logging of abandoned calls.





## Delayed Ringing

Menu Access Keyboard Shortcut	System Data Name	Memory Block
 +BCM	* Delayed Ringing Timer Assignment (CO)	1-1-77
 +BI	Delayed Ringing Timer Assignment (ICM)	1-2-26
 +BTT	CO/PBX Ring Assignment (Day Mode)	4-01
 +BTT	CO/PBX Ring Assignment (Night Mode)	4-02
 +BTM	Line Selection for Telephone Mode	4-12
 +BTM	Extension Line Key Ring Assignment (Day Mode)	4-37
 +BTM	Extension Line Key Ring Assignment (Night Mode)	4-38

### Dial 9 for Attendant

Menu Access Keyboard Shortcut	System Data Name	Memory Block
 +BA	Access Code (1-Digit) Assignment	1-1-46
 +BA	Specified Station Access Code Assignment	1-2-08
 +BTS	Class of Service (Attendant) Feature Selection 1	1-8-07
 +BTT	Station to Class of Service Feature Assignment	4-17

### Digit Insertion

Menu Access Keyboard Shortcut	System Data Name	Memory Block
 +BA	* Access Code (1~3-Digit) Assignment	1-1-46~48
 +BCS	* Networking Trunk Group/Route Advance Assignment	1-1-49
 +BCS	* CO/PBX Outgoing Digit Add Assignment	1-1-50
 +BCT	Trunk-to-Trunk Group Assignment	3-03
 +BS	Station Number Assignment	4-10

The diagram shows the Memory Blocks programmed for Digit Insertion.

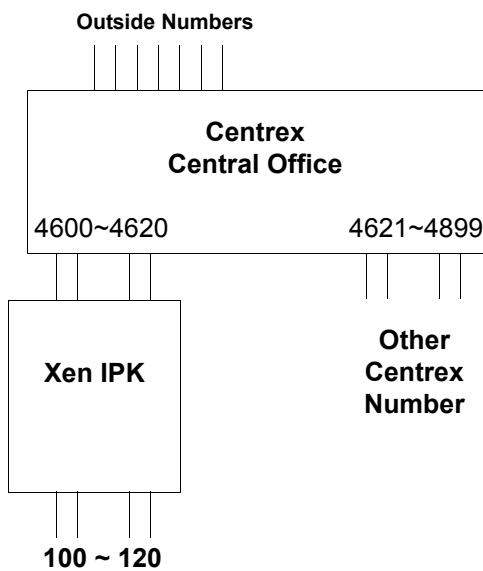

#### Calling

Outside Call – Dial 0 (System adds '0')  
 Centrex Call – 46XX ~ 48XX

#### Abbreviations:

AC = Access Code  
 BLK = Block  
 MB = Memory Block

#### MB 1-1-46

AC 9 = Item 401

#### MB 1-1-47

AC 46 = Item 402  
 AC 47 = Item 403  
 AC 48 = Item 404













#### MB 1-1-49

BLK 01= 101  
 BLK 02= 101  
 BLK 03= 101  
 BLK 04= 101













#### MB 1-1-50

BLK 01= Add 9  
 BLK 02= Add 46  
 BLK 03= Add 47  
 BLK 04= Add 48

**Digital Voice Mail**



Menu Access Keyboard Shortcut	System Data Name	Memory Block
 +BTD	Attendant Add-On Console Key Selection	1-6-05
 +BTS	Class of Service (Station) Feature Selection 2	1-8-08 (Pg.4, LK5 & LK6)
 +BN	Line Key Selection for Tenant Mode	2-06
 +BCT	DIT Assignment	3-42
 +BCT	ANA Assignment	3-43
 +AV	Live Recording Trunk Selection	3-45
 +BS	Station Number Assignment	4-10
 +BTM	Line Key Selection for Telephone Mode	4-12
 +BTT	Intercom Master Hunt Number Selection	4-14
 +BTT	Intercom Master Hunt Number Forward Selection	4-15
 +BTT	Station to Class of Service Feature Assignment	4-17
 +BS	Telephone Type Assignment	7-2

**Direct Inward Dialling (DID)**















Menu Access Keyboard Shortcut	System Data Name	Memory Block
 +ALM	Tie Line Delay Ringing Timer Selection	1-1-07
 +ALN	DID Digit Length Selection	1-1-20
 +ALN	DID Digit conversion Assignment	1-1-21
 +ALN	DID Digit Conversion Table	1-1-22
 +ALN	DID Forward Station Number for Undefined Digit	1-1-23
 +ALN	Tie Line First Ring Pattern Selection	1-1-34
 +ALN	Tie Line Delay Ring Pattern Selection	1-1-53
 +ALN	DID Line Ringing Pattern Selection	1-1-55
 +BCT	Trunk-to-Trunk Group Assignment	3-03
 +ALT	Tie Line Type Assignment	3-14
 +ALM	Tie Line Length of Wink Signal Selection	3-21
 +ALM	Tie Line Length of Delay Signal Selection	3-22
 +BCT	Tie Line Dial Tone Selection	3-27



**Direct Inward Dialing (DID) (Continued)**

Menu Access Keyboard Shortcut	System Data Name	Memory Block
 +ALT	Trunk Type Selection	3-91
 +ALN	Digit Add/Delete for Tie Line Networking	5-00
 +BS	Card Interface Slot Assignment	7-1





**Direct Inward System Access (DISA) without VRS Message**

Menu Access Keyboard Shortcut	System Data Name	Memory Block
 +BA	Access Codes (1~3-Digit) Assignment	1-1-46~48 (Items 251, 252, and 253)
 +AU	Automated Attendant First Digit PBR Release Timer Selection	1-4-01
 +AU	Automated Attendant PBR Timeout Response Selection	1-4-08
 +AU	* Automated Attendant Message Day/Night Mode Selection	1-4-11
 +AU	Automated Attendant Message Access Code (1-Digit) Assignment	1-4-14
 +AU	Automated Attendant Message Access Code (2-Digit) Assignment	1-4-15
 +BTI	* SLT or Automated Attendant/DISA to PBR Selection	1-8-01
 +AU	PBR Receive Level Assignment for Automated Attendant/DISA	1-8-02
 +BTS	Class of Service (Attendant) Feature Selection 1	1-8-07 (Pg. 2, LK 5 and LK6)
 +BTS	Class of Service (Station) Feature Selection 2	1-8-08 (Pg. 2, LK8)
 +BD	DISA ID Code Assignment	1-9-00
 +BD	DISA Password Effect/Invalid Selection	1-9-02
 +BCT	* Trunk Incoming Answer Mode Selection	3-05
 +BD	DISA ID Number Station Assignment	4-26



**Direct Inward System Access (DISA) with VRS Message**

Menu Access Keyboard Shortcut	System Data Name	Memory Block
 +BA	Access Code (1-, 2-, or 3-Digit) Assignment	1-1-46/47/48 (Items 251, 252, 253, and 501)
 +AU	Automated Attendant First Digit PBR Release Timer Selection	1-4-01
 +AT	Tandem Transfer SMDR Print Extension Assignment	1-4-04
 +AU	Automated Attendant PBR Timeout Response Selection	1-4-08
 +AU	Automated Attendant PBR Start Time Selection	1-4-09
 +AU	* Automated Attendant Message Day/Night Mode Selection	1-4-11
 +AU	Automated Attendant Message to Tenant Assignment	1-4-12
 +AU	Automated Attendant Answer Delay Time Assignment	1-4-13
 +AU	Automated Attendant Message Access Code (1-Digit) Assignment	1-4-14
 +AU	Automated Attendant Message Access Code (2-Digit) Assignment	1-4-15
 +AU	Automated Attendant Message Repeat Selection	1-4-16
 +BTI	* SLT or Automated Attendant/DISA to PBR Selection	1-8-01
 +AU	PBR Receive Level Assignment for Automated Attendant/ DISA	1-8-02
 +BTS	Class of Service (Attendant) Feature Selection 1	1-8-07 (Pg. 2, LK 5 and LK6)
 +BTS	Class of Service (Station) Feature Selection 2	1-8-08 (Pg. 2, LK8)
 +AR	VRS Message Recording Time Selection	1-8-12
 +AR	VRS Message Function Assignment	1-8-13
 +BI	Tone Assignment	1-8-15 (Table 2)
 +BD	DISA ID Code Assignment	1-9-00
 +BD	DISA Password Effect/Invalid Selection	1-9-02
 +BCT	* Trunk Incoming Answer Mode Selection	3-05
 +AU	Automated Attendant Message to Trunk Selection	3-38
 +BD	DISA ID Number Station Assignment	4-26







**Direct Inward Termination**

Menu Access Keyboard Shortcut	System Data Name	Memory Block
 +BT	Call Forward No Answer Timer Selection	1-2-22
 +BCT	* DIT Assignment	3-42
 +BCT	* ANA Assignment	3-43
 +BTT	Call Forward – Busy Immediately/Delay Selection	4-42





**Direct Paging Access**

Menu Access Keyboard Shortcut	System Data Name	Memory Block
 +BA	Access code (1-, 2- or 3-Digit) Assignment	1-1-46/47/48
 +BTD	Attendant Add-On Console Key Assignment	1-6-05
 +BTM	Line Key Selection Telephone Mode	4-12







**Direct Station Selection**

Menu Access Keyboard Shortcut	System Data Name	Memory Block
 +BTD	Attendant Add-On Console to Telephone Port Assignment	1-6-01
 +BTD	DSS Call Voice/Tone Selection	1-6-03
 +BTD	Attendant Add-On Console Key Selection	1-6-05
 +BN	Line Key Selection	2-05
 +BN	Line Key Selection for Tenant Mode	2-06
 +BTM	Line Key Selection for Telephone Mode	4-12
 +BS	Card Interface Slot Assignment	7-2



**Distinctive Ringing**

Menu Access Keyboard Shortcut	System Data Name	Memory Block
 +BT	CO/PBX Incoming Ringing alarm Time Selection	1-1-06
 +BTS	Distinctive Ringing by Telephone or CO Selection	1-1-28
 +BCS	CO Line Ringing Pattern Selection	1-1-51
 +BCS	PBX Line Ringing Pattern Selection	1-1-52







**Distinctive Ringing (Continued)**

Menu Access Keyboard Shortcut	System Data Name	Memory Block
 +ALN	Tie Line Delay Ring Pattern Selection	1-1-53
 +BCS	Synchronous Ringing Selection	1-1-59
 +BCT	CO/PBX Ringing Variation Selection	3-07
 +BTT	CO Ringing Pattern Selection for Telephone Mode	4-55
 +BTT	CO Line Ringing Pattern by Telephone or CO Selection	4-57
 +BCT	CO Ringing Pattern Selection for CO/PBX Line Mode	3-67



**Do Not Disturb**

Menu Access Keyboard Shortcut	System Data Name	Memory Block
 +BTS	Class of Service (Attendant) Feature Selection 1	1-8-07
 +BTS	Class of Service (Station) Feature Selection 2	1-8-08
 +BTT	Station to Class of Service Feature Assignment	4-17





**Door/Monitor Telephone**

Menu Access Keyboard Shortcut	System Data Name	Memory Block
 +BTP	Doorphone Assignment	1-7-00
 +BTP	Doorphone Display Time Selection	1-7-01
 +BTP	CO/PBX Ringing Pattern Selection	1-7-04
 +BTP	CO/PBX Ringing Frequency Selection	1-7-05
 +BTP	CO/PBX Chime Assignment (Day Mode)	4-03
 +BTP	CO/PBX Chime Assignment (Night Mode)	4-04















### Drop Key

Menu Access Keyboard Shortcut	System Data Name	Memory Block
 +BN	Line Key Selection	2-05
 +BN	Line Key Selection for Tenant Mode	2-06
 +BTM	Line Key Selection for Telephone Mode	4-12









### Elapsed Call Timer

Menu Access Keyboard Shortcut	System Data Name	Memory Block
 +BT	Start Timer Selection	1-1-05
 +BCT	Polarity Reverse Selection	3-90
 +BTM	Line Key Selection for Telephone Mode	4-12
 +BS	Card Interface Slot Assignment	7-1







### E & M Tie Lines (4-Wire)

Menu Access Keyboard Shortcut	System Data Name	Memory Block
 +ALM	Tie Line Delay Ringing Timer Selection	1-1-07
 +ALN	Tie Line First Ring Pattern Selection	1-1-34
 +ALN	Tie Line Delay Ring Pattern Selection	1-1-53
 +AC	Tie Line Code Restriction Assignment	1-1-69
 +BCT	Trunk-to-Trunk Group Assignment	3-03
 +ALT	Tie Line Type Assignment	3-14
 +BCT	Trunk DTMF Duration/Interdigit Selection	3-15
 +ALM	Tie Line Prepause Time Selection	3-16
 +ALM	Tie Line Answer Detect Time Selection	3-17
 +ALM	Tie Line Release Detect Time Selection	3-18
 +BCT	Tie Line/CO/PBX Incoming Signal Detect Time Selection	3-19
 +ALM	Tie Line Loop Off-Guard Time Selection	3-20
 +ALM	Tie Line Length of Wink Signal Selection	3-21
 +ALM	Tie Line Length of Delay Signal Selection	3-22
 +ALM	Tie Line Incoming Interdigit Timeout Selection	3-24



**E & M Tie Lines (4-Wire) (Continued)**

Menu Access Keyboard Shortcut	System Data Name	Memory Block
 +ALM	Tie Line Wink/Delay Signal Detect Timeout Selection	3-25
 +ALT	Tie Line Dial Tone Selection	3-27
 +ALT	Tie Line Reorder Tone Selection	3-28
 +ALT	Trunk Internal Transmit Pad Selection	3-29
 +ALT	Trunk Internal Receive Pad Selection	3-30
 +ALT	Trunk External Transmit Pad Selection	3-31
 +ALT	Trunk External Receive Pad Selection	3-32
 +BCT	Trunk Type Selection	3-91
 +BCT	Trunk (Installed, DP/DTMF) Selection	3-92





**Equal Access Accommodation**

Menu Access Keyboard Shortcut	System Data Name	Memory Block
 +AC	8-Digit Matching Table to Class Assignment	1-1-61
 +AC	OCC Table Assignment	1-1-67
 +AC	8-Digit Matching Table to OCC Table Assignment	1-1-68
 +AC	* Code Restriction Class Assignment (Day Mode)	4-07
 +AC	* Code Restriction Class Assignment (Night Mode)	4-08
 +AC	OCC Table to Trunk Group Assignment	5-03



**External Tone Ringer**

Menu Access Keyboard Shortcut	System Data Name	Memory Block
 +BP	External Ring Relay Cycle Selection	1-7-07
 +BN	* ECR Relay to Tenant Assignment	2-08



**External Zone Paging (Meet-Me)**

Menu Access Keyboard Shortcut	System Data Name	Memory Block
 +BA	Access Code (1-, 2-, or 3-Digit) Assignment	1-1-46/47/48
 +BTD	Attendant Add-On Console Key Assignment	1-6-05
 +BN	Line Key Selection	2-05
 +BN	Line Key Selection for Tenant Mode	2-06
 +BTM	Line Key Selection for Telephone Mode	4-12



**Feature Access - User Programmable**

Menu Access Keyboard Shortcut	System Data Name	Memory Block
 +BN	Line Key Selection	2-05
 +BN	Line Key Selection for Tenant Mode	2-06
 +BTM	Line Key Selection for Telephone Mode	4-12









**Flexible Line Assignment**

Menu Access Keyboard Shortcut	System Data Name	Memory Block
 +BN	Line Key Selection	2-05
 +BN	Line Key Selection for Tenant Mode	2-06
 +BTM	Line Key Selection for Telephone Mode	4-12

















**Flexible Numbering Plan**

Menu Access Keyboard Shortcut	System Data Name	Memory Block
 +BA	Access Code (1- or 2-Digit) Assignment	1-1-46/47
 +BS	2-, 3-, or 4-Digit Station Numbering Selection	1-2-03
 +BS	* Station Number Assignment	4-10

**Flexible Ringing Assignment**

Menu Access Keyboard Shortcut	System Data Name	Memory Block
 +BTS	Distinctive Ring by Telephone or CO Selection	1-1-28
 +BCT	CO/PBX Ringing Variation Selection	3-07
 +BTT	CO/PBX Ring Assignment (Day Mode)	4-01
 +BTT	CO/PBX Ring Assignment (Night Mode)	4-02
 +BTM	Extension Line Key Ring Assignment (Day Mode)	4-37
 +BTM	Extension Line Key Ring Assignment (Night Mode)	4-38
 +BTM	* Off-Hook Ringing Selection	4-51
 +BTM	Telephone Ringing Variation Selection	4-91

**Flexible Timeouts**











Menu Access Keyboard Shortcut	System Data Name	Memory Block
 +BCM	Pause Time Selection	1-1-00
 +BCM	DP Interdigit Time Selection	1-1-01
 +BCM	Hookflash Time Selection	1-1-02
 +BT	Hold Recall Time Selection (Non-Exclusive Hold)	1-1-03
 +BT	Start Timer Selection	1-1-05
 +BT	CO/PBX Incoming Ringing Alarm Time Selection	1-1-06
 +ALM	Tie Line Delay Ringing Timer Selection	1-1-07
 +BT	Station Transfer/Camp-On Recall Timer Selection	1-1-12
 +BT	Trunk Queuing Timeout Selection	1-1-37
 +BCM	CO/PBX Prepause Timer Selection	1-1-57
 +BT	Hold Recall Time Selection (Exclusive)	1-1-63
 +BT	Attendant Add-On Console Transfer/Camp-On Recall Timer Selection	1-1-64
 +AR	First Delay Announcement Start Time Selection	1-1-71
 +AR	First to Second Delay Announcement Interval Time Selection	1-1-73
 +AR	Second Delay Announcement Repeat Interval Time Selection	1-1-75
 +AN	ISDN DTMFD duration/Interdigit Time Selection	1-1-80



**Flexible Timeouts (Continued)**

Menu Access Keyboard Shortcut	System Data Name	Memory Block
 +BP	Internal Paging Timeout Selection	1-2-00
 +BT	Automatic Callback Release Timer Selection	1-2-02
 +BT	Call Forward No Answer Timer Selection	1-2-22
 +BT	System Call Park Recall Time Selection	1-2-23
 +BTI	Bounce Protect Time Selection	1-3-01
 +BTI	First Digit PBR Release Timer Selection	1-3-03
 +BTI	Hookflash Start Time Selection	1-3-05
 +BTI	Hookflash End Time Selection	1-3-06
 +AV	Voice Mail DTMF Delay Time Selection	1-3-08
 +AV	Voice Mail Disconnect Time Selection	1-3-09
 +AV	Voice Mail DTMF Duration/Interdigit Time Selection	1-3-10
 +AT	Tandem Transfer Automatic Disconnect Timer Selection	1-4-00
 +AU	Automated Attendant First Digit PBR Release Timer Selection	1-4-01
 +AU	Automated Attendant Transfer Delayed Ringing Time Selection	1-4-02
 +AU	Automated Attendant No Answer Disconnect Time Selection	1-4-03
 +AU	Automated Attendant Answer Delay Time Assignment	1-4-13
 +AU	Automated Attendant 1st to 2nd Delay Announcement Interval	1-4-19
 +AU	Automated Attendant Delay Announcement Disconnect Time Selection	1-4-20
 +AS	SMDR Valid Call Timer Assignment	1-5-25
 +BTP	Doorphone Display Time Selection	1-7-01
 +BP	External Paging Timeout Selection	1-7-06
 +BP	External Speaker Chime Start Time Selection	1-7-09
 +BT	PBR Interdigit Release Timer Selection	1-8-10
 +BT	System Refresh Timer Assignment	1-8-11
 +AA	ACD/UCD Overflow Timer Selection	1-12-02
 +BCT	Trunk DTMF Duration/Interdigit Selection	3-15



**Flexible Timeouts (Continued)**

Menu Access Keyboard Shortcut	System Data Name	Memory Block
 +ALM	Tie Line Prepause Time Selection	3-16
 +ALM	Tie Line Answer Detect Time Selection	3-17
 +ALM	Tie Line Release Detect Time Selection	3-18
 +BCT	Tie Line CO/PBX Incoming Signal Detect Time Selection	3-19
 +ALM	Tie Line Loop Off-Guard Time Selection	3-20
 +ALM	Tie Line Length of Wink Signal Selection	3-21
 +ALM	Tie Line Length of Delay Signal Selection	3-22
 +ALM	Tie Line Incoming Interdigit Timeout Selection	3-24
 +ALM	Tie Line Wink/Delay Signal Detect Timeout Selection	3-25
 +BCT	Disconnect Recognition Time Selection	3-33



**Full Handsfree Operation**

Menu Access Keyboard Shortcut	System Data Name	Memory Block
 +BTM	* HFU Selection	4-29



**Group Listening**

Menu Access Keyboard Shortcut	System Data Name	Memory Block
 +BTS	* Class of Service (Station) Feature Selection 2	1-8-08
 +BTT	Station to Class of Service Feature Assignment	4-17



### Headset Connection

Menu Access Keyboard Shortcut	System Data Name	Memory Block
 +BN	Line Key Selection	2-05
 +BN	Line Key Selection for Tenant Mode	2-06
 +BTM	* Line Key Selection for Telephone Mode	4-12

### Hold with Recall (Exclusive and Non-Exclusive)

Menu Access Keyboard Shortcut	System Data Name	Memory Block
 +BT	Hold Recall Timer Selection (Non-Exclusive Hold)	1-1-03
 +BT	Hold Recall Time Selection (Exclusive)	1-1-63
 +BTM	Hold/Transfer Recall Display Selection	4-30



### Hot Line

Menu Access Keyboard Shortcut	System Data Name	Memory Block
 +BA	Access Code (1-, 2-, or 3-Digit) Assignment	1-1-46/47/48
 +BTT	Prime Line/Hot Line Assignment	4-23



### Howler Tone Service

Menu Access Keyboard Shortcut	System Data Name	Memory Block
 +BI	Tone Assignment	1-8-15





### Incoming Call Identification

Menu Access Keyboard Shortcut	System Data Name	Memory Block
 +BCT	Trunk Name/Number Assignment	3-00
 +BTT	Station Name Assignment	4-18











**Internal Voice/Tone Signalling**

Menu Access Keyboard Shortcut	System Data Name	Memory Block
 +BI	Intercom Call Voice/Tone Signal Selection	1-2-01
 +BTD	DSS Call Voice/Tone Signal Selection	1-6-03





**Internal Zone Paging (Meet-Me)**

Menu Access Keyboard Shortcut	System Data Name	Memory Block
 +BP	Internal Paging Timeout Selection	1-2-00
 +BP	Internal Paging Alert Tone Selection	1-2-25
 +BTT	Receiving Internal/All Call Page Selection	4-31
 +BTM	* Internal Zone Paging Selection	4-93













**ISDN - Basic Rate**

Menu Access Keyboard Shortcut	System Data Name	Memory Block
 +AN	ISDN DTMF Duration/Interdigit Selection	1-1-80
 +BCT	* Trunk Name/Number Assignment	3-00
 +AN	ISDN Trunk Directory Number Assignment	3-52
 +BS	Card Interface Slot Assignment	7-1
 +FZ	*Master Clock Source Selection	1-8-33
 +FZ	*Trunk Type Selection	3-91
 +FZ	Line Key Selection for Telephone Mode	4-12
 +FZ	Ring Assignment (Day)	4-01
 +FZ	Ring Assignment (Night)	4-02
 +AN	*BRT Connect Configuration	3.72







**ISDN - Caller ID**

Menu Access Keyboard Shortcut	System Data Name	Memory Block
 +AI	Caller ID Display Assignment for System Mode	1-1-78
 +BTS	Class of Service (Station) Feature Selection 2	1-8-08 (Pg. LK3/LK4)
 +AI	Caller ID Display Assignment for CO/PBX Line	3-44
 +AI	Caller Name Indication Selection	3-53



**ISDN - Primary Rate**

Menu Access Keyboard Shortcut	System Data Name	Memory Block
 +AN	ISDN DTMF Duration/Interdigit Time Selection	1-1-80
 +AN	* PRI ISDN Channel Number Selection	1-13-00
 +BCT	* Trunk Name/Number Assignment	3-00
 +AN	* ISDN Trunk Directory Number Assignment	3-52
 +AN	* Card Interface Slot Assignment	7-1
 +FZ	*Master Cook Source Selection	1-8-33
 +FZ	*Trunk Type Selection	3-91
 +FZ	Line Key Selection for Telephone Mode	4-12
 +FZ	Ring Assignment (Day)	4-01
 +FZ	Ring Assignment (Night)	4-02
 +AN	PRT B Channel Outgoing Priority Selection	1-13-04
 +AN	PRT Channel Map Assignment	1-12-05

**Least Cost Routing (LCR)**

Menu Access Keyboard Shortcut	System Data Name	Memory Block
 +BA	Access Code (1-, 2-, or 3-Digit) Assignment	1-1-46/47/48
 +BCT	Trunk-to-Trunk Group Assignment	3-03
 +BCT	Trunk Type Selection	3-91
 +BTT	* LCR Class Selection	4-40
 +BS	Card Interface Slot Assignment	7-1
 +BS	MIF (LCR) Assignment	7-3-01





**Live Monitoring**

Menu Access Keyboard Shortcut	System Data Name	Memory Block
 +BTS	Class of Service Feature Selection 2	1-8-08 (Page 5 LK6)
 +BTM	* Line Key Selection for Telephone Mode	4-12



**Message Waiting**

Menu Access Keyboard Shortcut	System Data Name	Memory Block
 +BTD	Attendant Add-On Console Key Selection	1-6-05



**Multiline Conference Bridge**

Menu Access Keyboard Shortcut	System Data Name	Memory Block
 +BS	Universal Assignment (Assignment slot with CNF as SLI(8))	7-1
 +BTT	Intercom Master Hunt Number Selection	4-14
 +BTT	Intercom Master Hunt Number Forward Assignment	4-15
 +BTI	Voicemail/SLT Selection	4-35



**Multilingual LCD Indication**

Menu Access Keyboard Shortcut	System Data Name	Memory Block
 +BI	Customised Message 1~10 Assignment	1-2-09 ~ 18
 +BTT	Station Name Assignment	4-18
 +BTM	* Multilingual LCD Indication Selection	4-28



**Multiple Trunk Groups**

Menu Access Keyboard Shortcut	System Data Name	Memory Block
 +BA	Access Code (1-, 2-, or 3-Digit) Assignment	1-1-46/47/48
 +BCT	Trunk-to-Trunk Group Assignment	3-03



**Music on Hold**

Menu Access Keyboard Shortcut	System Data Name	Memory Block
 +BCS	Music on Hold Pattern Selection	1-8-09
 +AN	CO External Source Selection	3-11
 +AN	CO Hold Melody Selection	3-12











**Night Call Pickup**

Menu Access Keyboard Shortcut	System Data Name	Memory Block
 +BA	Access Code (1-, 2-, or 3-Digit) Assignment	1-1-46/47/48
 +BN	ECR Relay to Tenant Assignment	2-08







**Night Chime**

Menu Access Keyboard Shortcut	System Data Name	Memory Block
 +BN	* ECR Relay to Tenant Assignment	2-08
 +BS	Card Interface Slot Assignment	7-1

**Night Transfer**

Menu Access Keyboard Shortcut	System Data Name	Memory Block
 +BTD	Attendant Add-On Console Key Selection	1-6-05
 +BTS	Class of Service (Attendant) Feature Selection 1	1-8-07
 +BN	Trunk to Tenant Assignment	2-01
 +BCT	Trunk-to-Trunk Group Assignment	3-03
 +BCT	ANA Assignment (Assigned Night Answer)	3-43
 +BCT	DIT Holiday Mode Enable	3-63
 +BCT	DIT Night Mode Delay Answer Enable	3-64
 +BTT	CO/PBX Ring Assignment (Day Mode)	4-01
 +BTT	CO/PBX Ring Assignment (Night Mode)	4-02
 +AC	Code Restriction Class Assignment (Day Mode)	4-07
 +AC	Code Restriction Class Assignment (Night Mode)	4-08





**Night Transfer (Continued)**

Menu Access Keyboard Shortcut	System Data Name	Memory Block
 +BTT	Telephone to Tenant Assignment	4-09
 +BTT	Station to Class of Service Feature Assignment	4-17
 +BTM	Extension Line Key Ring Assignment (Day Mode)	4-37
 +BTM	Extension Line Key Ring Assignment (Night Mode)	4-38
 +BTM	CO/PBX Answer Key Operation without Ringing Assignment (DY)	4-52
 +BTM	CO/PBX Answer Key Operation without Ringing Assignment (NT)	4-53





**Off-Hook Ringing Selection**

Menu Access Keyboard Shortcut	System Data Name	Memory Block
 +BTS	Off-Hook Ringing Selection	4-51

**PC Programming**



Menu Access Keyboard Shortcut	System Data Name	Memory Block
 +CSP	PC Programming Password Assignment	1-8-17
 +CSN	Site Name Assignment	1-8-18
 +BS	Card Interface Slot Assignment	7-1
 +BS	MIF (LCR) Assignment	7-3-01
 +BS	MIF (SMDR) Assignment	7-3-02

**Pooled Line (Outgoing)**



Menu Access Keyboard Shortcut	System Data Name	Memory Block
 +BN	Line Key Selection	2-05
 +BN	Line Key Selection for Tenant Mode	2-06
 +BCT	Trunk-to-Trunk Group Assignment	3-03
 +BTM	* Line Key Selection for Telephone Mode	4-12



### Preset Dialling

Menu Access Keyboard Shortcut	System Data Name	Memory Block
 +BTS	Class of service (Station) Feature Selection 2	1-8-08 Page 5 Line Key 5
 +AI	Caller ID/Preset Dial Outgoing CO Selection	4-44





### Prime Line Assignment

Menu Access Keyboard Shortcut	System Data Name	Memory Block
 +BA	Access Code (1-, 2-, or 3-Digit) Assignment	1-1-46/47/48
 +BTT	* Prime Line/Hot Line Assignment	4-23

### Private Lines

Menu Access Keyboard Shortcut	System Data Name	Memory Block
 +BCS	** Private Line Assignment	1-1-29

### Privacy Release

Menu Access Keyboard Shortcut	System Data Name	Memory Block
 +BN	Trunk to Tenant Assignment	2-01
 +BN	Line Key Selection	2-05
 +BN	Line Key Selection for Tenant Mode	2-06
 +BTT	Telephone to Tenant Assignment	4-09
 +BTM	Line Key Selection for Telephone Mode	4-12



### Recall Key

Menu Access Keyboard Shortcut	System Data Name	Memory Block
 +BCM	** Hookflash Time Selection	1-1-02







**Restriction (Outgoing)**

Menu Access Keyboard Shortcut	System Data Name	Memory Block
 +BTT	* Trunk Outgoing Restriction	4-19





**Ringling Line Preference**

Menu Access Keyboard Shortcut	System Data Name	Memory Block
 +BTS	Class of Service (Station) Feature Selection 2	1-8-08
 +BTM	* Ringing Line Preference Selection	4-11
 +BTM	SIE/CAR Ringing Line Preference Selection	4-41







**Route Advance Block**

Menu Access Keyboard Shortcut	System Data Name	Memory Block
 +BCS	* Route Advance Block Assignment	1-1-30
 +BA	Access Code (1-, 2-, or 3-Digit) Assignment	1-1-46/47/48
 +BN	Line Key Selection	2-05
 +BN	Line Key Selection for Tenant Mode	2-06
 +BCT	Trunk-to-Trunk Group Assignment	3-03
 +BTM	* Line Key Selection for Telephone Mode	4-12

**Scrolling Directories**

Menu Access Keyboard Shortcut	System Data Name	Memory Block
 +AC	System Speed Dial Restriction by Tenant	1-1-18
 +BE	Speed Dial Number/Name Display Selection	1-1-33
 +BE	Speed Dial Buffer Allocation	1-1-35
 +BN	System Speed Dial Display Assignment	2-07





### Secondary Incoming Extension

Menu Access Keyboard Shortcut	System Data Name	Memory Block
 +BN	Line Key Selection	2-05
 +BN	Line Key Selection for Tenant Mode	2-06
 +BTM	* Line Key Selection for Telephone Mode	4-12
 +BTM	Extension Line Key Ring Assignment (Day Mode)	4-37
 +BTM	Extension Line Key Ring Assignment (Night Mode)	4-38
 +BTM	SIE/CAR Ringing Line Preference Selection	4-41







### Seized Trunk Number Display

Menu Access Keyboard Shortcut	System Data Name	Memory Block
 +BCT	* Trunk Name/Number Assignment	3-00











### Simplified Call Distribution

Menu Access Keyboard Shortcut	System Data Name	Memory Block
 +AAA	SCD (Simplified Call Distribution) Pilot Number Assignment	1-8-29
 +AA	SCD Group Agent Assignment	1-8-30
 +BLT	DIT Assignment	3-42
 +BLT	ANA Assignment	3-43



### Single Line Telephone Access

Menu Access Keyboard Shortcut	System Data Name	Memory Block
 +BTI	Bounce Protect Time Selection	1-3-01
 +BTI	SLT Hookflash Signal Selection	1-3-02
 +BTI	First Digit PBR Release Timer Selection	1-3-03
 +BTI	Dial 1 (DP) Hookflash Selection	1-3-04
 +BTI	Hookflash Start Time Selection	1-3-05
 +BTI	Hookflash End Time Selection	1-3-06
 +BTI	SLT or Automated Attendant/DISA to PBR Selection	1-8-01



**Single Line Telephone Access (Continued)**

Menu Access Keyboard Shortcut	System Data Name	Memory Block
 +BCT	DIT Assignment	3-42
 +BCT	ANA Assignment	3-43
 +BTT	CO/PBX Ring Assignment (Day Mode)	4-01
 +BTT	CO/PBX Ring Assignment (Night Mode)	4-02
 +BTT	Telephone to Tenant Assignment	4-09
 +BTT	Station Name Assignment	4-18
 +BTI	SLT Hookflash Assignment	4-24
 +BTI	Voice Mail/SLT Selection	4-35
 +BTT	SLT Data Line Security Assignment	4-90
 +BTI	DTMF/DP SLT Type Selection	4-95



**SLT Adapter**

Menu Access Keyboard Shortcut	System Data Name	Memory Block
 +BS	Station Number Assignment	4-10
 +BS	Telephone Type Assignment	7-2

**SLT Timed Alarm**

Menu Access Keyboard Shortcut	System Data Name	Memory Block
 +BA	Access Code (1-, 2-, or 3-Digit) Assignment	1-1-46/47/48
 +BTS	Class of Service (Attendant) Feature Selection 1	1-8-07
 +BTT	Station to Class of Service Feature Assignment	4-17







**Speed Dial Stored Characters**

Menu Access Keyboard Shortcut	System Data Name	Memory Block
 +BE	Speed Dial Number/Name Display Selection	1-1-33
 +BE	Speed Dial Buffer Allocation	1-1-35



### Speed Dial Station

Menu Access Keyboard Shortcut	System Data Name	Memory Block
 +BE	Speed Dial Buffer Allocation	1-1-35









### Speed Dial System

Menu Access Keyboard Shortcut	System Data Name	Memory Block
 +AC	System Speed Dial Restriction by Tenant	1-1-18
 +BE	Speed Dial Number/Name Display Selection	1-1-33
 +BE	Speed Dial Buffer Allocation	1-1-35
 +AC	System Speed Dial Override by Class Selection	1-1-62
 +BTS	Class of Service (Attendant) Feature Selection 1	1-8-07
 +BN	System Speed Dial Display Assignment	2-07
 +BTT	Station to Class of Service Feature Assignment	4-17





### Station Hunting

Menu Access Keyboard Shortcut	System Data Name	Memory Block
 +BTT	* Intercom Master Hunt Number Selection	4-14
 +BTT	** Intercom Master Hunt Number Forward Assignment	4-15





### Station Message Detail Recording (SMDR)

Menu Access Keyboard Shortcut	System Data Name	Memory Block
 +BT	Start Timer Selection	1-1-05
 +AS	SMDR Print Format	1-5-02
 +AS	* Printer Connected Selection	1-5-13
 +AS	Printer Line Feed Control Selection	1-5-14
 +AS	SMDR Valid Call Timer Assignment	1-5-25
 +AS	SMDR Incoming/Outgoing Print Selection	1-5-26
 +BS	Card Interface Slot Assignment	7-1
 +BS	MIF (LCR) Assignment	7-3-01
 +BS	MIF (SMDR) Assignment	7-3-02





**Station Outgoing Lockout**

Menu Access Keyboard Shortcut	System Data Name	Memory Block
 +BA	* Access Code (1-, 2-, or 3-Digit) Assignment	1-1-46/47/48
 +AC	Code Restriction Class Assignment when Lockout is Set	1-1-70
 +BTS	Class of Service (Station) Feature Selection 2	1-8-08
 +BTT	Station to Class of Service Feature Assignment	4-17



**Station Relocation**

Menu Access Keyboard Shortcut	System Data Name	Memory Block
 +BA	* Access Code (1-, 2-, or 3-Digit) Assignment	1-1-46/47/48
 +BTS	Class of Service (Attendant) Feature Selection 1	1-8-07 (Pg. 3, LK1)
 +BTS	Class of Service (Station) Feature Selection 2	1-8-08 (Pg. 5, LK3)
 +BTT	Station to Class of Service Feature Assignment	4-17

**Station Transfer**

Menu Access Keyboard Shortcut	System Data Name	Memory Block
 +BTS	System Transfer/Camp-On Selection	1-1-11
 +BT	System Transfer/Camp-On Recall Timer Selection	1-1-12
 +BCS	CO Transfer Ring Pattern Selection	1-1-13
 +BCS	CO Transfer Ring Tone Selection	1-1-14

**Step Call**

Menu Access Keyboard Shortcut	System Data Name	Memory Block
 +BA	Intercom Feature Access Code Assignment	1-2-24
 +BTS	Class of Service (Station) Feature Selection 2	1-8-08
 +BTT	Station to Class of Service Feature Assignment	4-17

### Stored Hookflash

Menu Access Keyboard Shortcut	System Data Name	Memory Block
 +BCM	Hookflash Time Selection	1-1-02

### Synchronous Ringing







Menu Access Keyboard Shortcut	System Data Name	Memory Block
 +BCS	Synchronous Ringing Selection	1-1-59

### Tandem Switching of 4-Wire E&M Tie Lines

Menu Access Keyboard Shortcut	System Data Name	Memory Block
 +ALN	Tie Line Networking Tandem Connection Assignment	5-01

Refer to *E & M Tie Lines (4-Wire)* on page 2573, *Uniform Numbering Network – Closed Numbering Plan* on page 2593, and *Uniform Numbering Network – Open Numbering Plan* on page 2594.



### Tenant Service

Menu Access Keyboard Shortcut	System Data Name	Memory Block
 +AU	Automated Attendant Message to Tenant Assignment	1-4-12
 +BN	Trunk to Tenant Assignment	2-01
 +BN	Line Key Selection	2-05
 +BN	Line Key Selection for Tenant Mode	2-06
 +BN	System Speed Dial Display Assignment	2-07
 +BN	ECR Relay to Tenant Assignment	2-08
 +BTT	Telephone to Tenant Assignment	4-09



### Three Minute Reminder

Menu Access Keyboard Shortcut	System Data Name	Memory Block
 +BTM	3-Minute Alarm Selection	4-94





**Tone Override**

Menu Access Keyboard Shortcut	System Data Name	Memory Block
 +BTS	Class of Service (Station) Feature Selection 2	1-8-08
 +BTT	Station to Class of Service Feature Assignment	4-17









**Trunk Queuing**

Menu Access Keyboard Shortcut	System Data Name	Memory Block
 +BT	Trunk Queuing Timeout Selection	1-1-37
 +BTS	Class of Service (Station) Feature Selection 2	1-8-08
 +BTT	Station to Class of Service Feature Assignment	4-17

**Trunk-to-Trunk Transfer**





Menu Access Keyboard Shortcut	System Data Name	Memory Block
 +AT	Tandem Transfer Automatic Disconnect Timer Selection	1-4-00
 +BTS	Class of Service (Attendant) Feature Selection 1	1-8-07
 +BTS	* Class of Service (Station) Feature Selection 2	1-8-08
 +BCT	* Trunk-to-Trunk Transfer Yes/No Selection	3-04
 +BTT	Station to Class of Service Feature Assignment	4-17

**Uniform Call Distribution (UCD)**

Menu Access Keyboard Shortcut	System Data Name	Memory Block
 +BA	* Access Code (1-, 2-, or 3-Digit) Assignment	1-1-46/47/48 (Items 031, 032 and 040)
 +BT	Call Forward No Answer Timer Selection	1-2-22
 +BTS	Class of Service (Station) Feature Selection 2	1-8-08 (Pg., LK1, LK4, and LK5)
 +AA	* ACD/UCD Group Agent Assignment	1-8-25
 +AA	* ACD/UCD Group Pilot Number Assignment	1-12-00
 +AA	ACD/UCD Group Overflow Destination Assignment	1-12-01
 +AA	ACD/UCD Group Overflow Timer Selection	1-12-02
 +BCT	* DIT Assignment	3-42









**Uniform Call Distribution (UCD) (Continued)**



Menu Access Keyboard Shortcut	System Data Name	Memory Block
 +BCT	* ANA Assignment	3-43
 +BCT	Polarity Reverse Selection	3-90
 +BTM	Line Key Selection for Telephone Mode	4-12
 +BS	Card Interface Slot Assignment	7-1
 +BS	MIF (UCD) Assignment	7-3-03

Refer to *Delay Announcement on page 2566*.

**Uniform Numbering Network – Closed Numbering Plan**

Menu Access Keyboard Shortcut	System Data Name	Memory Block
 +BA	* Access Code (1-, 2-, or 3-Digit) Assignment	1-1-46/47/48
 +BCS	* Networking Trunk Group/Route Advance Assignment	1-1-49
 +BCS	* CO/PBX Outgoing Digit Add Assignment	1-1-50
 +BCT	Trunk-to-Trunk Group Assignment	3-03
 +BCT	Trunk (Installed, DP/DTMF) Selection	3-92
 +BS	Station Number Assignment	4-10
 +ALN	Tie Line Networking Tandem Connection Assignment	5-01

**Voice Mail Message LED on LK/DSS**

Menu Access Keyboard Shortcut	System Data Name	Memory Block
 +BTS	Class of Service (Station) Feature Selection 2	1-8-08
 +BTT	Station to Class of Service Feature Assignment	4-17
 +AV	Voice Mail Quick Transfer Master Hunt Number	1-8-26

**Example:**

The diagram provides an example of Memory Blocks that would be programmed for a Closed Numbering Plan.

**Abbreviations used in the diagram:**

AC = Access Codes      BLK = Block      MB = Memory Block      TRK = Trunk  
 ACG = Access Item Code      LN = Line      TG = Trunk Group      UD = Uniform Dial

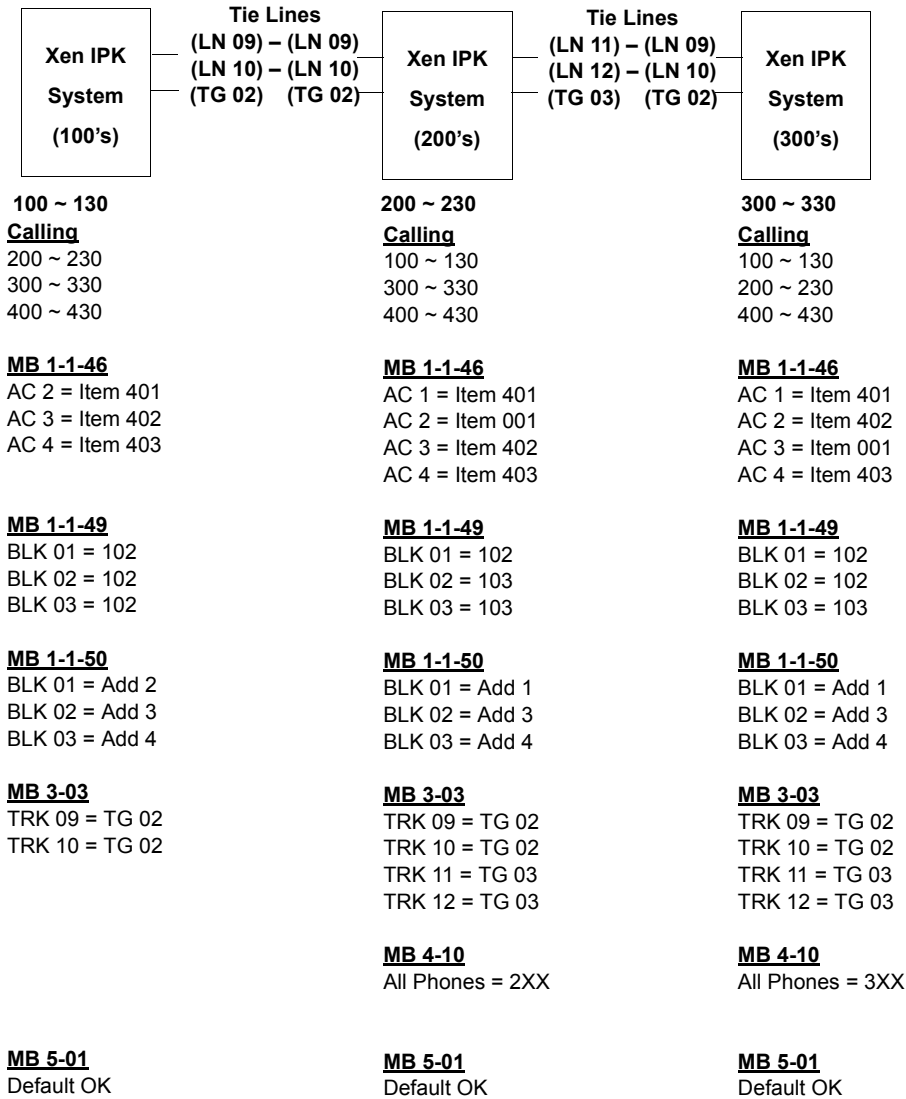

**Uniform Numbering Network – Open Numbering Plan**

Menu Access Keyboard Shortcut	System Data Name	Memory Block
+BA	* Access Code (1-, 2-, or 3-Digit) Assignment	1-1-46/47/48
+BCS	* Networking Trunk Group/Route Advance Assignment	1-1-49
+BCS	* CO/PBX Outgoing Digit Add Assignment	1-1-50
+BCT	Trunk-to-Trunk Group Assignment	3-03
+BCT	Trunk (Installed, DP/DTMF) Selection	3-92

Doc. No.: 8194 - Release 2.0  
December 2004

### Uniform Numbering Network – Open Numbering Plan (Continued)

Menu Access Keyboard Shortcut	System Data Name	Memory Block
+BS	Station Number Assignment	4-10
+ALN	Tie Line Networking Tandem Connection Assignment	5-01

Example:



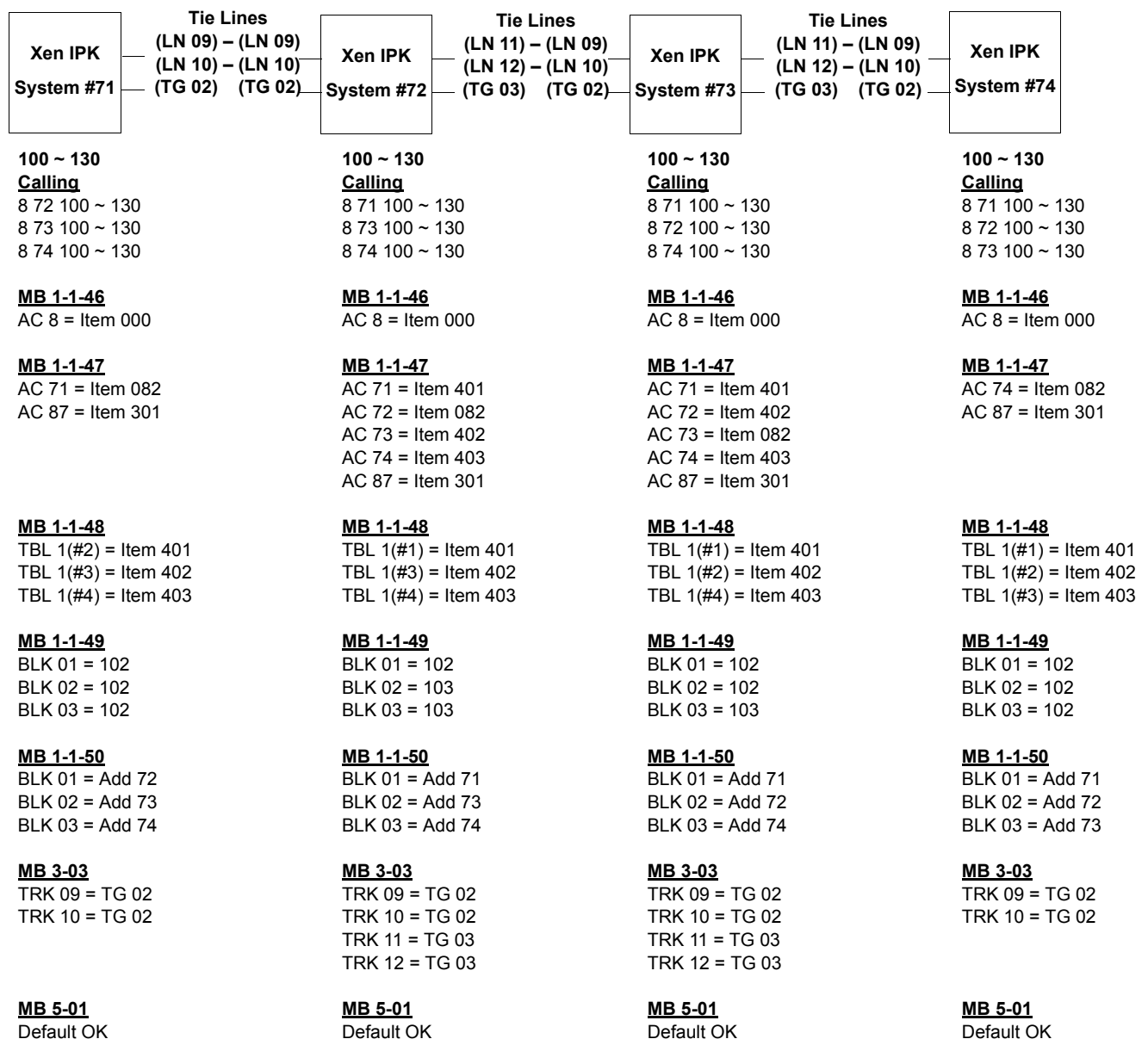

This diagram provides an example of Memory Blocks that would be programmed for a Closed Numbering Plan.

**Abbreviations used in the diagram:**

- AC = Access Codes
- BLK = Block
- MB = Memory Block
- LN = Line
- TBL = Table
- TRK = Trunk
- TG = Trunk Group















### Universal Slots

Menu Access Keyboard Shortcut	System Data Name	Memory Block
 +BS	Card Interface Slot Assignment	7-1
 +BS	MIF (ACD) Assignment	7-3-00
 +BS	MIF (LCR) Assignment	7-3-01
 +BS	MIF (SMDR) Assignment	7-3-02
 +BS	MIF (UCD) Assignment	7-3-03



### Unsupervised Conference

Menu Access Keyboard Shortcut	System Data Name	Memory Block
 +BTS	* Class of Service (Station) Feature Selection 2	1-8-08





### Voice Mail Integration

Menu Access Keyboard Shortcut	System Data Name	Memory Block
 +BA	* Access Code (1-, 2-, or 3-Digit) Assignment	1-1-46/47/48
 +BTI	Bounce Protect Time Selection	1-3-01
 +BTI	Hookflash Start Time Selection	1-3-05
 +BTI	Hookflash End Time Selection	1-3-06
 +AV	Voice Mail Digit Add Assignment	1-3-07
 +AV	Voice Mail DTMF Delay Time Selection	1-3-08
 +AV	Voice Mail Disconnect Time Selection	1-3-09
 +AV	Voice Mail DTMF Duration/Interdigit Time Selection	1-3-10
 +AV	Voice Mail Quick Transfer Master Hunt Number	1-8-26
 +BTT	Intercom Master Hunt Number Selection	4-14
 +BTT	Intercom Master Hunt Number Forward Selection	4-15
 +BTI	* Voice Mail/SLT Selection	4-35

**Voice Over Split**

Menu Access Keyboard Shortcut	System Data Name	Memory Block
 +BA	Intercom Feature Access Code Assignment	1-2-24 (Item 006)
 +BTS	Class of Service (Station) Feature Selection 2	1-8-08 (Pg. 1, LK8 and Pg. 3, LK3)

**Voice Prompt**

Menu Access Keyboard Shortcut	System Data Name	Memory Block
 +BA	* Access Code (1-, 2-, or 3-Digit) Assignment	1-1-46/47/48 (Item 501)
 +AR	VRS Message Recording Time Selection	1-8-12
 +AR	* VRS Message Function Assignment	1-8-13
 +AR	Voice Prompt to Tone Assignment	1-8-16
 +BTT	** Voice Prompt Selection	4-36

THIS PAGE INTENTIONALLY LEFT BLANK

### SECTION 1 GENERAL INFORMATION

This chapter provides detailed information for programming using the Xen Maintenance Access Terminal (MAT) software.

#### PC requirements:

- ④ Microsoft Windows 95 operating system
- ④ Available serial communication port on PC
- ④ MNP Class 4 or V.42 bis modem (if remote programming is required)

#### KTS hardware requirements:

- ④ MIFM-U( ) KTU
- ④ IMPORTANT

A second initialisation is recommended after a normal upload. System with VMS, FMS, ACD and/or IPT cards installed, please ensure all cards had completed their startup sequence before performing a second initialisation.

These cards are considered fully 'started up' about 5 minutes after power is applied.

### SECTION 2 FEATURES OF PC PROGRAMMING

Some of the features of PC programming include:

*Wizard* Allows a user to select a feature using Wizard. *Wizard* prompts the user to program the necessary system data items associated with the feature. When *Wizard* is selected, a tabbed list of information is provided.

(For a detailed discussion of *Wizard*, refer to *Section 4 Wizard on page 600.*)

*System Data Upload/Download* Allows system data to be transferred from/to a personal computer to provide backup of data.

## SECTION 3

### SOFTWARE INSTALLATION

#### Installing Xen Maintenance Access Terminal (MAT) Software

1. Insert the MAT setup disk 1 in your floppy drive.  
(If installing the CD ROM version, insert Setup CD in the CD ROM drive.)
2. Click the Windows ( ) **Start** button.
3. Select **Run**.
4. Enter **a:\setup.exe** and click OK.  
(If installing from CD ROM, enter the letter of the CD ROM drive.)
5. Follow the instructions on the PC installation program.
6. To start the MAT program:
  - Click the Win 95 start button.
  - Select PROGRAMS, NEC Xen MAT.
  - Click Xen Maintenance Access Terminal (MAT).
  - Enter the password. The default password is PASSWORD in uppercase letters.

## SECTION 4

### WIZARD

The *Wizard* organises system data assignments for programming individual features. When the user selects *Wizard*, the system provides a tabbed list of information related to the selected feature.

*Wizard* can be accessed by using the Wizard button from the toolbar or by selecting **Wizard** from the File pulldown menu. (Refer to *Figure 3-1: Accessing Wizard*.)



Select  from the toolbar.

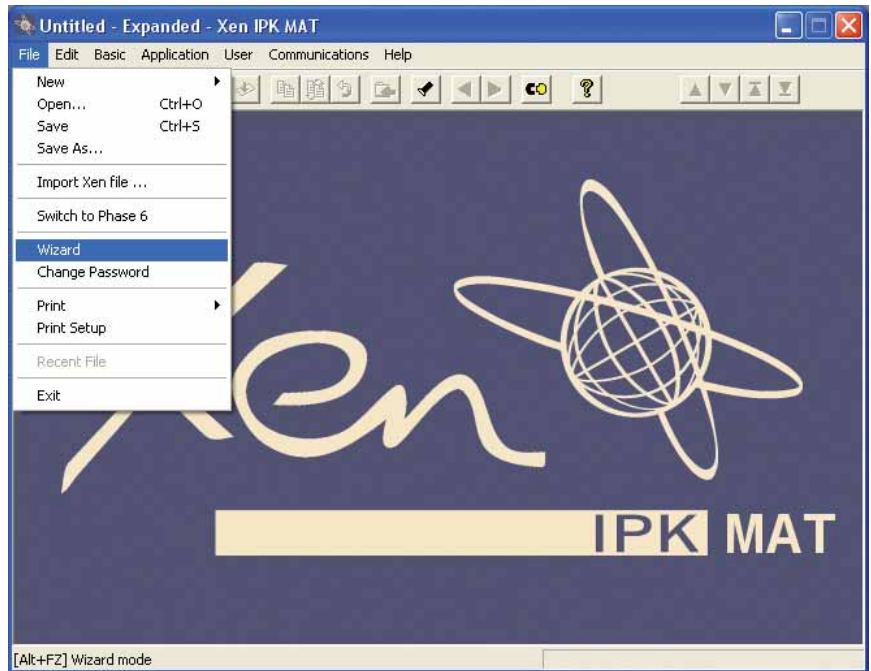

Figure 3-1: Accessing Wizard

When *Wizard* is displayed, the technician can select any feature from the list or can begin entering letters of the feature name. As the name is being entered, Quick Search finds the matching letters and highlights the match.



Figure 3-2: Selecting Wizard for a Feature

When a feature is selected, all system related data items for that feature are presented in sequence. Enter the required values in the current tab and click next to advance to the next tab. Click back to go to previous tab. In Figure 3-3: Sample Wizard, the Account Code Entry feature is selected.

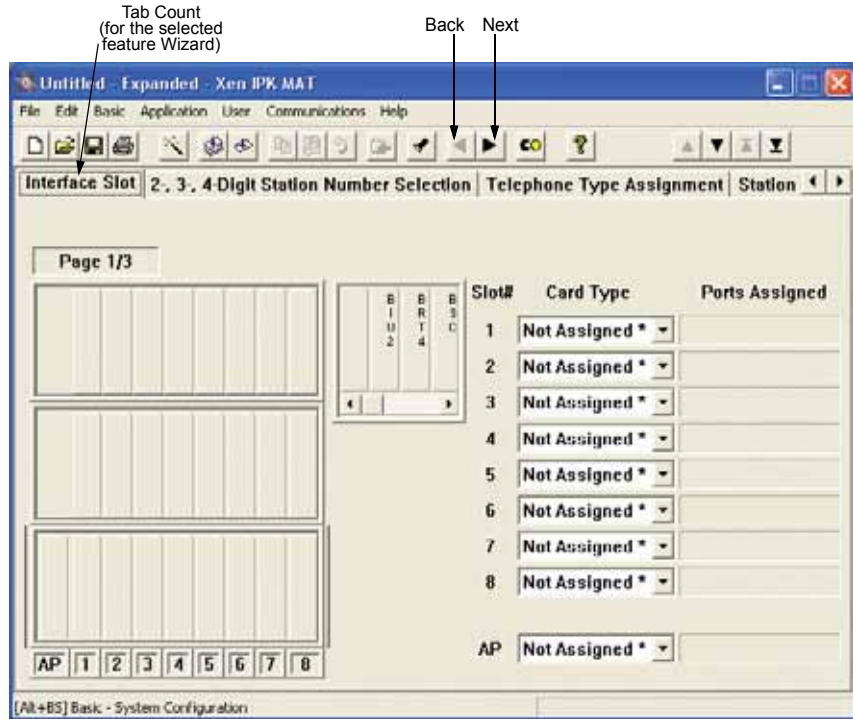

Figure 3-3: Sample Wizard

## SECTION 5

### PROGRAMMING SCREENS

#### **Main Menu**

When the MAT software program is launched, the Main Menu screen is displayed first. This screen allows the user to access the options used to program the Xen system. *Figure 3-4: Xen IPK Maintenance Access Terminal Software Screen Samples* shows the menu and describes the layout.

#### **Pull-down Menu**

Pull-down menus are available for each function involved in programming the Xen system. To access the data associated with the function, click on the function name on the Main Menu. Some of the options on the initial pull-down menu offer several selections. An arrow to the right of the option name indicates additional selections are available. Refer to *Figure 3-4: Xen IPK Maintenance Access Terminal Software Screen Samples* for an example of a Pull-down Menu.

#### **System Data Screen**

When an option is selected from a pull-down menu, a screen is displayed that allows the user to program data for the function selected. *Figure 3-4: Xen IPK Maintenance Access Terminal Software Screen Samples* shows an example of a System Data Screen. This screen indicates three tabs. The tabs indicate system data items that are grouped together for programming. The active tab group is indicated by a box around the tab title. In the example, the displayed data is for the *Terminal/System Wide* tab group. To access another tab group, press the tab or use the keyboard shortcut. Keyboard shortcuts are displayed at the bottom of the screen in the Information Bar.

### Main Menu



### Pulldown Menu

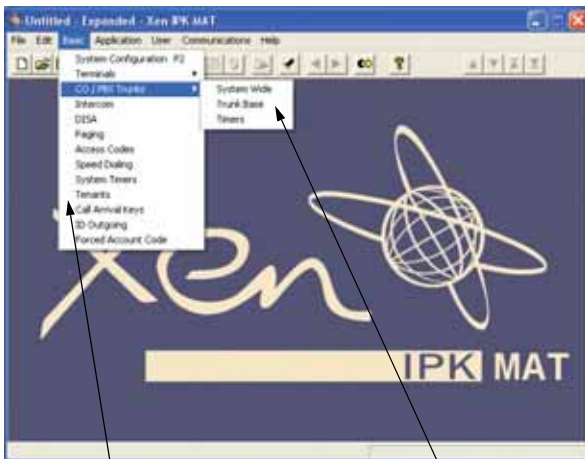

Pulldown Menu  
Make selections by clicking on an item. The associated screen is displayed.

The arrow indicates additional information is available for this option.

### System Data Item Screen

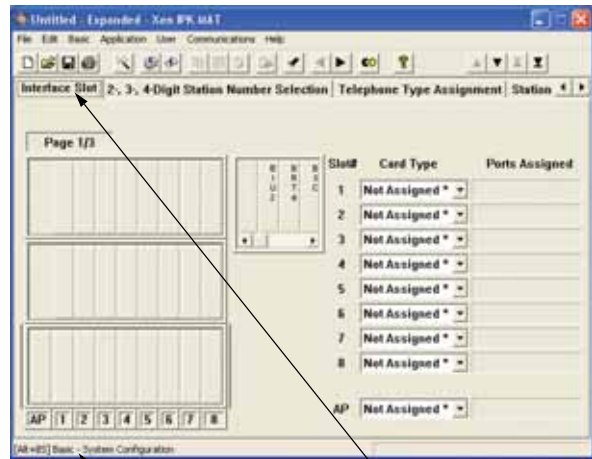

Information Bar indicates Keyboard Shortcut.

Tab Groups  
The active Tab Group is indicated by the darkened box surrounding the tab name.

Figure 3-4: Xen IPK Maintenance Access Terminal Software Screen Samples

## SECTION 6

### TOOLBAR

Several icons are provided to allow the user to navigate the program. The icons in the toolbar are explained in this section. The availability of the individual tools depends on the activity the user is performing. When the icon appears shadowed, the tool is not available. When the icon is dark, the tool is available. Refer to *Figure 3-4: Xen IPK Maintenance Access Terminal Software Screen Samples* for an example.



Creates a new customer configuration file.



Loads or opens an existing customer configuration file.



Saves the customer configuration file to the hard disk, or floppy disk.



Accesses the Job Specifications printing option.



Accesses the *Wizard* for individual features.



Sets the defaults for *all* items on the open tab.



Sets the defaults for the individual system data items (on the screen the default is set for the item where the cursor is blinking).



Allows data items to be copied between ports.



Allows values between two ports to be swapped.



Allows the user to undo the current edits and return to the previous editing operation.



Takes you to the previous tab.



Accesses Quick Search. Quick Search provides a detailed list of system data items.



Returns to the previous tab group.



Advances to the next tab group.



Displays the help contents for the Xen MAT software program.



Scrolls up displaying the previous page.



Scrolls down displaying the next page.



Advances to the first page.



Advances to the last page.



Brings up the Connection Dialogue Box

## SECTION 7

### XEN IPK PULLDOWN MENUS

This section explains each of the pulldown menus that are available in the MAT software.

#### **File**

The File pulldown menu provides options for basic file management.

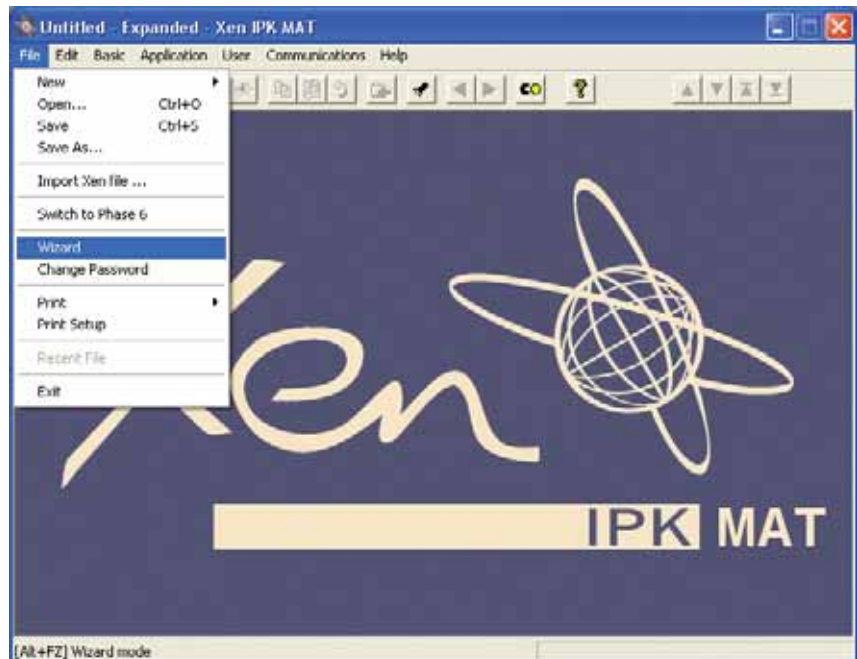

Figure 3-5: File Menu

#### **New**

Creates a new configuration file.

#### **Open**

Loads an existing configuration.

#### **Save**

Saves the configuration file. This option is only available when a configuration file is open.

#### **Save As**

Saves a configuration file using a new name. This option is only available when a configuration file is open.

#### **Close**

Closes the current configuration file. This option is only available when a configuration file is open.

## Wizard

Accesses the Wizard. Wizard is available for every feature offered in the Xen system. Wizard provides all of the information necessary to program a feature. All of the system data items necessary for programming the feature are grouped together. The user can press the appropriate tabs to access system data and make the necessary changes.

This option is only available when a configuration file is open.

## Change Password

Allows the user to change the MAT password.

## Print

Provides two print options: Job Specifications and Designation Labels (requires a standard inkjet or laser printer).

When Job Specifications is selected, a menu is displayed. There are three options for printing the Job Specifications: printing a family (group) such as system-wide, trunk group, or tenant, printing a range of Memory Blocks, or printing an individual Memory Block.

When Designation Labels is selected, MAT automatically opens the DESI for Windows label printing application. The current telephone information is automatically exported to DESI. Labels can then be configured and printed for the telephones. This requires the NEC LASER Labels for printing on InkJet or Laser printers.

**Note:** For the Designation Labels option to be enabled, the DESI for Windows application must be installed on your computer. Installation is usually done during the installation of MAT.

## Print Setup

Allows access to the printer setup screen. This allows the printer configuration to be modified.

## Recent File

Displays the last two files that were opened. These are listed as 1 and 2. The user can select either file to open. This option is only available when New or Open is selected.

## Exit

Exits the programming software. If changes have not been saved, the technician is prompted to save the changes before the program shuts down.



## Edit

The Edit pulldown menu allows files to be edited or swapped.

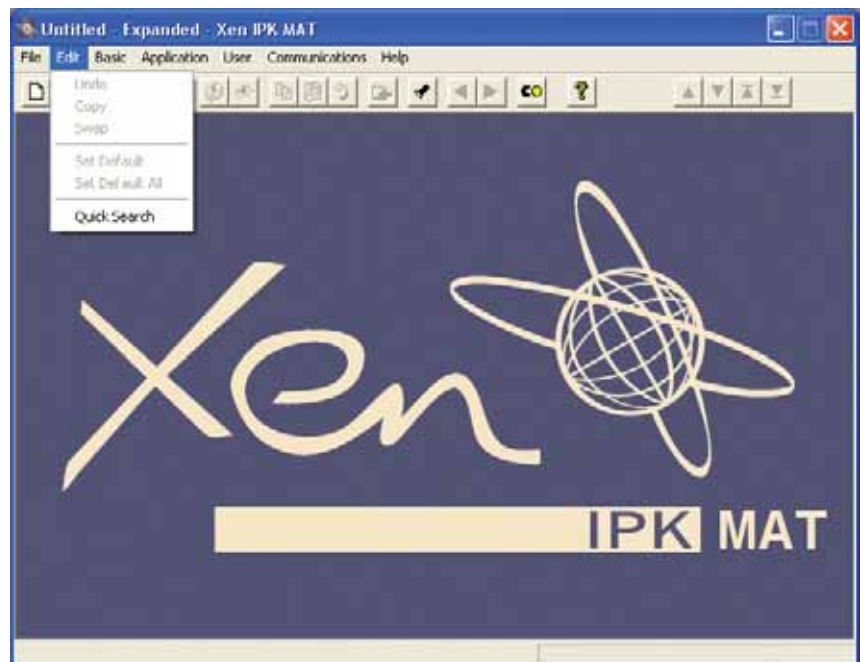

Figure 3-6: Edit Menu

### Undo

Allows the user to undo current edits and return to the previous editing operation.

### Copy

Brings up the copy screen. This allows port information to be copied from one port to another.

### Swap

Allows values *between* two ports to be swapped.

### Set Default

Defaults to the current field where the cursor is positioned.

### Set Default All

Allows the user to set all values to default on the open tab.

### Quick Search

Allows the user to search the Memory Blocks by Memory Block Number, Memory Block Name, or Tab Name. After the search method is specified, a list is provided. The user can scroll through the list and click on the desired Memory Block. System data can then be modified as necessary.

## Basic

The Basic pulldown menu allows access to basic programming items.

**Note:** Some menu items may be disabled if the appropriate hardware is not assigned, or a dependent data item is not set.

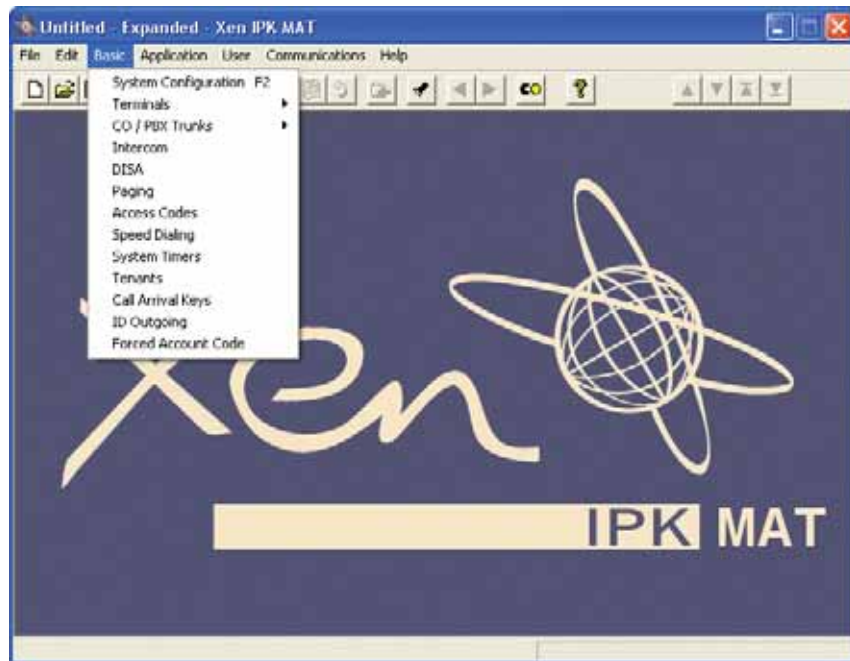

Figure 3-7: Basic Menu

## System Configuration

This option allows the technician to configure the customer system by indicating the cards that are installed for each slot in the KSU.

## Terminals



This option allows the technician to assign the terminals to the system. Several selections are available with this option.

- System Wide
- Station Base
- Multiline
- Single Line
- DSS/BLF
- Doorphones

## CO/PBX Trunks

This option allows technicians to program system data related to trunk assignments.

Three selections are available with this option:

-  System Wide
-  Trunk Base
-  Timers

## Intercom

This option allows the technician to program system data related to intercom assignments

## DISA

This option allows the technician to assign codes for Direct Inward System Access (DISA).

## Paging

This option allows data related to paging assignments to be programmed.

## Access Codes

This option allows the technician to enter Access Codes. Where appropriate, Access Codes are set to default system values.

## Speed Dialling

This option allows data related to system and station speed dialling to be programmed.

## System Timers

This option allows system-wide timers to be assigned.

## Tenants

This option allows data related to tenant assignments to be programmed.

## Call Arrival Keys

This option allows Call Arrival block assignments to be programmed.

## Forced Account Codes

This option allows the technician to program the account code length and to assign account codes.

## Application

The Application pulldown menu allows access to system data items relating to advanced system applications.

### Code Restriction

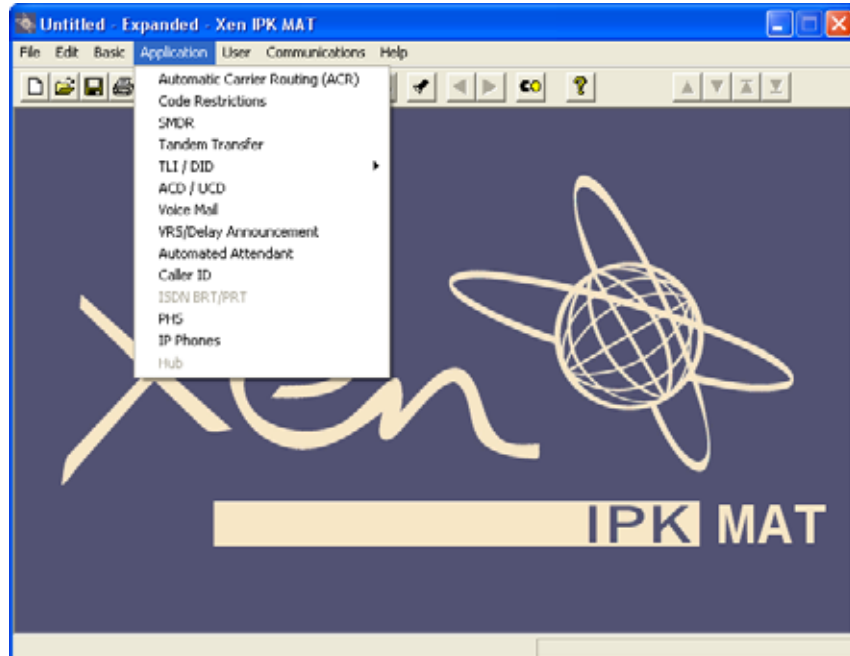

Figure 3-8: Application Menu

This option allows code restriction assignments to be programmed.

### SMDR

This option allows data related to Station Message Detail Recording to be programmed.

### Tandem Transfer

This option allows the assignment of data related to the routing of a call through the system.

### TLI/DID

This option allows data related to Tie Lines and Direct Inward Dialling to be programmed.

Three selections are available with this option:

- ④ Trunk Base
- ④ Networking
- ④ Timers

**ACD/UCD**

This option allows the technician to set up Automatic Call Distribution and Uniform Call Distribution Hunt groups.

**Voice Mail**

This options allows data related to the internal voice mail to be programmed.

**VRS/Delay Announcement**

This option allows data to be assigned for the VRS ETU (e.g., greetings).

**Automated Attendant**

This option allows the technician to program the data related to messaging.

**Caller ID**

This option allows Caller ID displays to be programmed and display assignments on a per-port basis to be assigned.

**ISDN BRT/PRT**

This option allows the assignment of information related to Basic Rate and Primary Rate ISDN trunks such as ISDN telephone numbers, and BRT DTMF duration.

**PHS**

This option allows the programming of data related to PHS (Personal Handy-phone System) such as PHS Telephone Assignment and PS Out of Area Tone Selection.

## User

The Users pulldown menu allows access to system data items related to speed dialling.

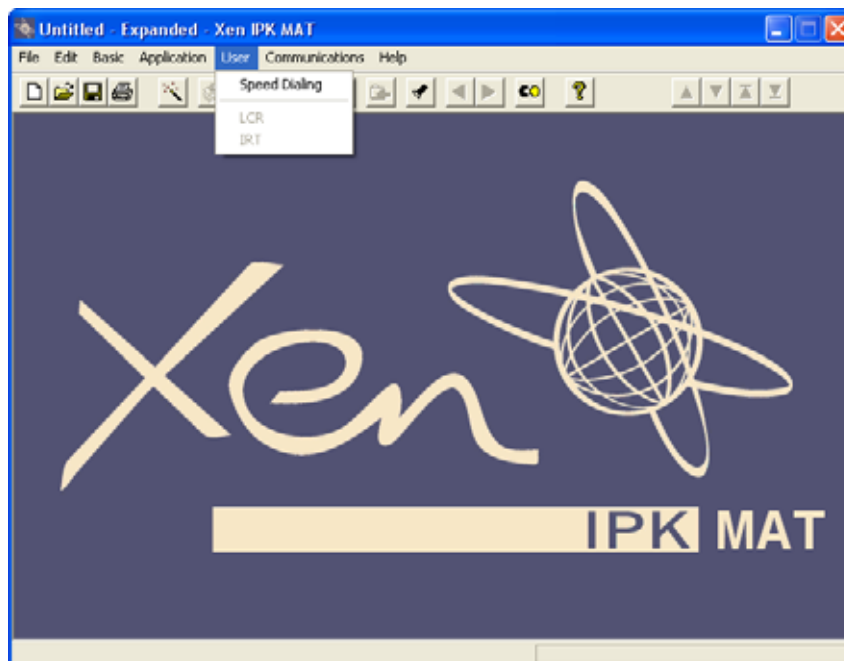

Figure 3-9: User Menu

## Speed Dialling

This option allows the technician to program Speed Dial memories for each Multiline Terminal in the Xen system.

## Communications

The Communications pulldown menu allows access to system data items relating to direct and remote connections to the Xen system.



Figure 3-10: Communications Menu

### Connect

This option allows the technician to connect to the Xen system.

Connection can be Direct or Remote. Direct connection is when the MAT PC is directly connected to the Xen system. With Remote connection, the MAT PC uses a modem to dial into another external remote modem that is connected to the Xen system. If the MIFM-U( ) KTU is equipped with a socket modem (modem kit part no. 750620), then the external remote modem is not needed. For Direct connection to the KTS, connect the serial cable included with the MAT from a free serial port on the MAT PC to the COM 1 port on the KTS. Select Communications, Connect. Select the Setup button to choose PC COM port. Choose Direct Connection and click the Connect button. For Remote connection to the KTS, choose Modem Connection and select the Dial button. For this type of connection, the PC must have an MNP Class 4 modem. This type of connection allows the user to program a KTS located at a remote location.

In either case, after a successful connection is established with the KTS, you are ready to upload and download data to and from the KTS.

**Disconnect**

This option allows the technician to disconnect from the Xen IPK system.

**Upload**

This option allows the technician to upload programming changes and configurations to the KTS.

**Download**

This option allows the technician to download the current Xen configuration.

**Verify**

This option allows the technician to compare the configuration programmed in the KTS with that of the PC.

**First Initialisation**

This option reinitialises the system to the factory-set defaults.

All active calls on the system are dropped.

**Second Initialisation**

This option reboots the system without resetting the programmed defaults (i.e., all programming is retained).

**Setup**

This option allows the technician to set up the system to provide communication. Four options are available for this selection.

- ④ PC Serial Port — serial port of the PC that is connected to the KTS.
- ④ End User Password — the password programmed in Memory Block 1-8-17 on the KTS.
- ④ Site Name — the name of the site that is being programmed.
- ④ Setup & Initialise — the KTS port settings/configurations.



## Help

The Help pulldown menu allows access to online help.



Figure 3-11: Help Menu

### Using Help

This option provides access to the help topics window that describes how to use the help function.

### Contents

This option provides access to the help topics that are available for the Xen Maintenance Access Terminal system.

### Help Topics

This options provides a list of help topics. The user can bookmark topics that they may want to refer to again.

### Show MB Numbers

When the cursor is positioned over a data field, the memory block number is displayed above the cursor.

### About

This option provides information about the Maintenance Access Terminal software (MAT).

THIS PAGE INTENTIONALLY LEFT BLANK