

Model: CX-920A



COIN PAYPHONE

Recommendation;
This Payphone should be installed in supervised locations Only.
Also See Notes on inside front Cover.



**Read this manual
carefully before
connecting line
and operating phone**



Issue 1
September 2006

Issued by Telephone Technical Services

Installation Notes for CX-920A payphone.

Phone is currently SETUP as follows;

To accept 10c 20c 50c \$1 & \$2,

Call Cost is 50c per meter pulse.

12Khz Metering.

Incoming calls limited to 10 mins

Important ;

- **This phone should be installed in a supervised location.**
- Confirm if Metering on Payphone Line is 12 Khz (Default), if Not 12Khz then change Program 12 to PTT 50Hz. (DO NOT USE ‘SELF 50Hz’ or ‘Self 12/16Khz’)
- An Earth connection is required for Every Installation
- Make sure that any internal cables are to the Left hand side and that they will not fowl internal operation.
- This Phone DOES NOT ACCEPT 5 cent coins and if used these may cause coin blockages
- Confirm that lightning protection is installed on payphone line.
This is crucial as repair costs after lighting strike or Electrical surge are NOT covered by warranty and are HIGH.
- The “Coin Release” lever on the Right hand side of phone is the FIRST thing that should be operated if a coin is stuck inside the phone.
- Put BOTH spare Keys in a safe place, as replacement keys are NOT available,
The complete lock has to be changed if both keys are lost.

Installation of Payphone



CX-331WM

The CX-920A payphone should be sited in a secure dry location with good lighting. It is recommended that the payphone be screwed to a wall using the WM-331WM bracket.

BEFORE connection of the CX-920A to the telephone line it is recommended that the telephone line be tested to confirm that the line is suitable for the CX-920A.

The line should be capable of supplying 20mA of line current **with the CX-920A connected,**

This can be confirmed by connecting a multimeter set to milliamps directly across the A & B legs **without** any equipment on the line, a current reading greater than 30mA will indicate that sufficient current is available. OR 20mA and greater when measured in series **with** the CX-920A when off hook.

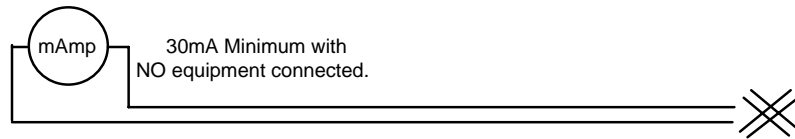

OR

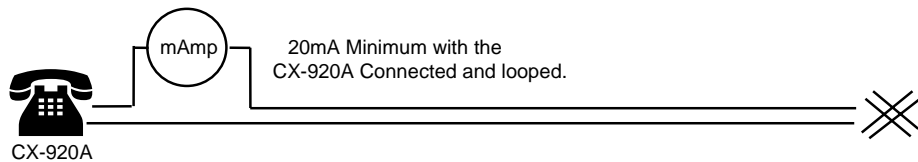

Test line to confirm correct Meter signal is present using suitable test equipment, Meter signal can be 50Hz or 12kHz. Note; Line is NOT polarity dependant.

Electrical Earth of less than 30 Ohms **MUST** be connected to the Centre Screw Terminal

After installation, **Check Programming** to confirm the programmed Metering is the same as the PTT line.

Test correct operation by dialling metering phone numbers
Also confirm operation of '000' emergency number. (coins are not required)

Installation of Payphone

CX920A

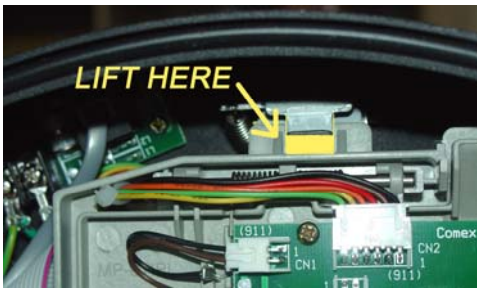

To Remove Coin Mechanism,

Disconnect Large Ribbon cable from Main Board including 2 Conductor Brown plug. Also other 2 Conductor Plug from CN14 connector in Top RH Corner of Main board (Brown & Black Colour).

Remove the Two screws in Mechanism Feet,

Lift sprung Lever at top of Mechanism (See Photo above left) Carefully slide Mechanism out from LHS disengaging 'Coin Release' lever interlink (See photo above centre).

Connect Telephone Line and Earth Cable to Screw terminals as shown in photo at right. *Line = Left & Right Terminal & Earth = Centre Terminal*

Carefully Replace Mechanism & return all cables to the Original positions.

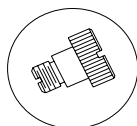
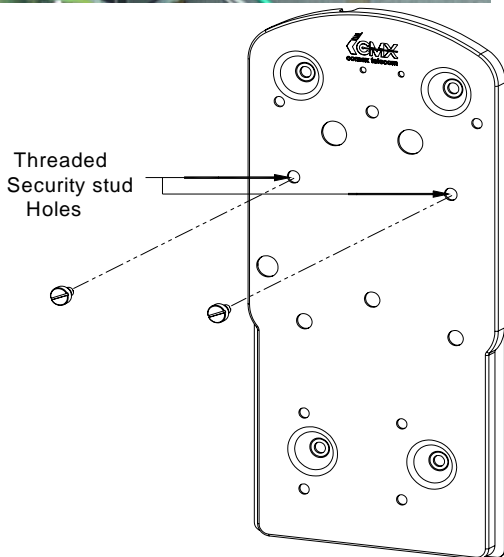

Security stud

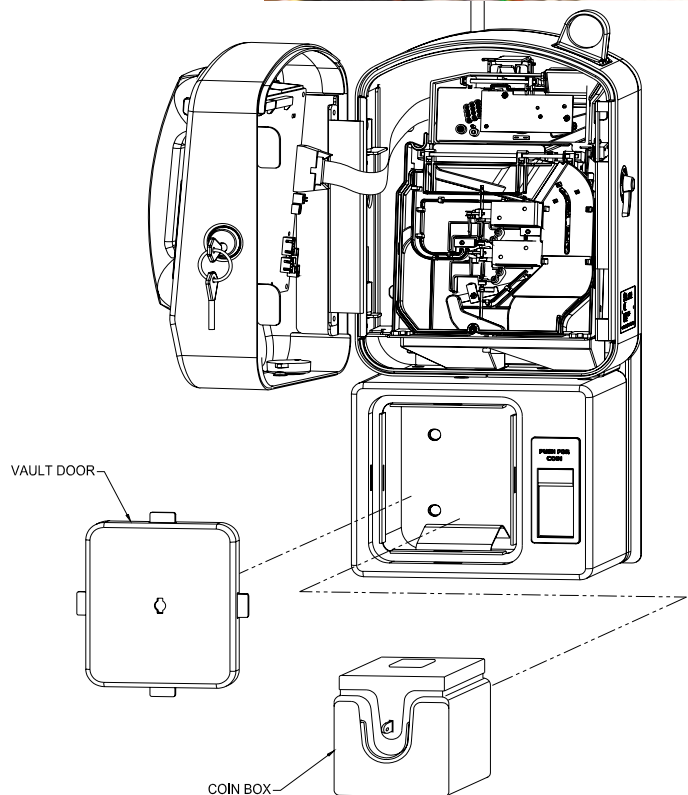

Payphone
(inside veiw)

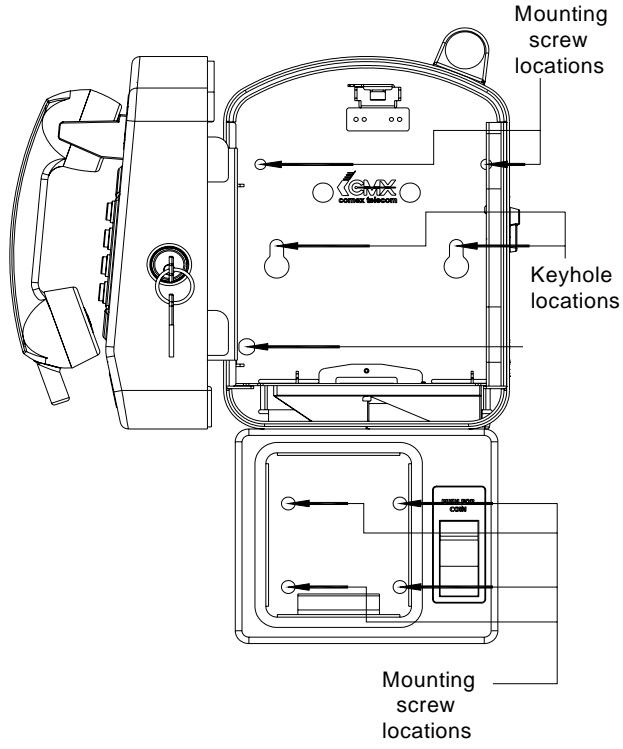

Mountion plate

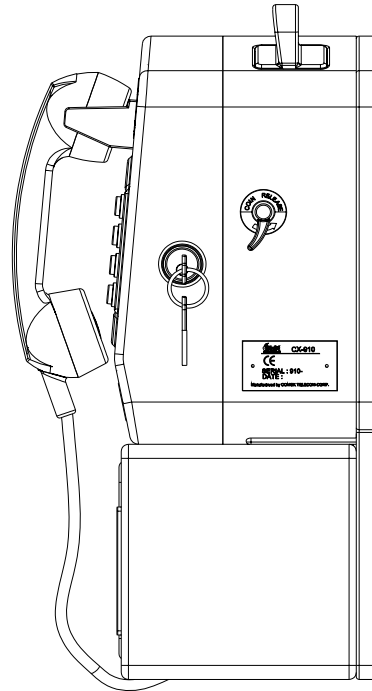
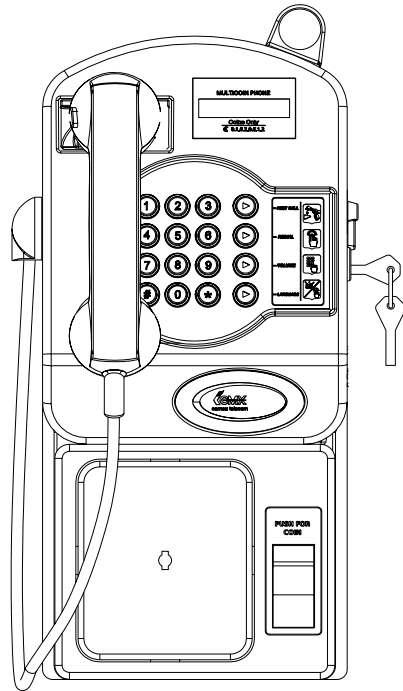
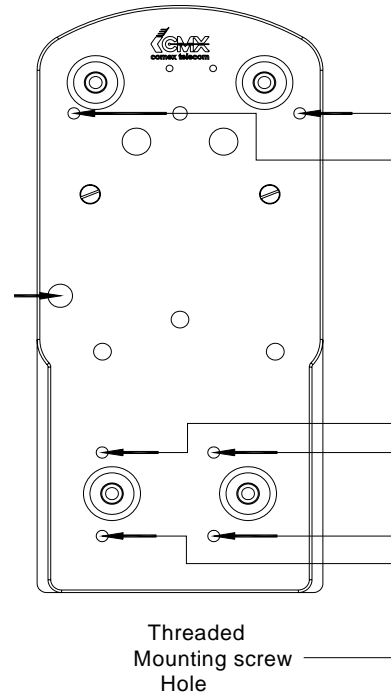

Testing and Programming

NO 5¢ COINS PLEASE
INSERT COINS SLOWLY ONE AT A TIME



Special Key Operations when in Program Mode.

- *** Key**
Use this key as an “**Escape**” key to return to the previous screen or to escape from the **Program Mode**.
- **# Key**
The # key is used to “**Save**” inputs in **Program Mode**.
- **Up / Down Selector on LCD Display**
When the “up/down” selector is shown on the left hand side of the LCD display, use the “**1**” key to increase the value or the “**4**” key to decrease the value.

When the “up/down” selector is shown in the centre of the LCD display, use the “**2**” key to increase the value or the “**5**” key to decrease the value.

When the “up/down” selector is shown on the right hand side of the LCD display, use the “**3**” key to increase the value or the “**6**” key to decrease the value.

To enter the program mode:

Lift the Handpiece, then press Program button 'SW5' on Bottom RHS corner of Main board which is inside front cover

100 PCS 50.40

Wait 2-3 seconds, Remove finger from button.

LCD will ask for 8-digit password =

ENTER PASSWORD

Enter password (*Default: 00 80 70 50*)

| No: | Program Name | Page |
|-----|---|------|
| 00 | Self Diagnosis – Phone testing function | 12 |
| 01 | Protect 10c | 13 |
| 02 | PTT Local – Assign a time limit for PTT local calls, 30 sec – 20 mins | 14 |
| 03 | Reserved | 14 |
| 04 | Free Call Programming – Max 4 free call numbers | 14 |
| 05 | Blocked Call Programming – Max 4 blocked numbers or prefixes | 15 |
| 06 | PTT Meter pulses detected. | 15 |
| 07 | Password Programming – Owner and Programming passwords | 15 |
| 08 | PTT or PABX Line – Select to suit line type | 16 |
| 09 | Reserved | 16 |
| 10 | Long Distance Call control | 16 |
| 11 | Incoming Call Programming – Set to restrict or enable incoming calls | 17 |
| 12 | Metering Type selection – Call charging control | 17 |
| 13 | Reserved | 18 |
| 14 | Coin Accumulation – Value of coins collected | 18 |
| 15 | Coin Validation – Set acceptance rate of local coins | 18 |
| 16 | Clock setting | 20 |
| 17 | Voice prompt selection | 20 |
| 18 | Coin Tin Capacity Setting – Number of coins | 20 |
| 19 | Unit Fee Programming – Sets charge rate per meter pulse or unit of time | 21 |
| 20 | Assign Tariff Band – Assign tariff band to prefix's | 21 |
| 21 | Tariff Programming – Set or Edit call cost and duration for each band | 23 |
| 22 | Minimum Insertion – Set minimum charge to make call (Display Value) | 25 |
| 23 | Service Fee – Set additional charge per call (Self tariffing only) | 25 |
| 24 | Tariff Band Limiting function | 26 |

To exit the program mode:

Press  key twice or replace the Handpiece

00 – Self Diagnosis

Using the self-diagnosis function:

- 1 – Keypad Testing.
- 2 – Coin Validator testing.
- 3 – Coin collect solenoid testing.

MAINTAIN (0-3): _

1 – Keypad Testing

Press **1** key

OFF HOOK

Press **2** key etc.

1111111111111111

2222222222222222

Press **New Call** key

aaaaaaaaaaaaaaaaaa

Press **Redial** key

bbbbbbbbbbbbbbbbbb

Press **Vol/Talk** key

cccccccccccccccccc

Press **Language** key

dddddddddddddddddd

Press **Coin Release** key

COIN JAM ACTIVE

Release **Coin Release** key

COIN JAM NORMAL

Remove Coin Tin

CASHBOX REMOVED

Replace Coin Tin

CASHBOX LOCATED

Handpiece Test OK

HANDSET GOOD

Handpiece Fail Test

HANDSET DEFECT

When the ***** key is pressed twice the keypad testing will stop.

2 – Coin Validator Testing

Coin Validator Testing includes:

- 1) **Photo diode (Optocoupler) testing:** To verify that all the emitting and receiving diodes are operating normally.

A display showing “1234” indicates that the four pairs of photo diodes are normal. If an “x” symbol is displayed, this indicates a defective diode.

- 2) **Oscillator Testing:** To verify that the two oscillator frequencies are normal. A display showing “999” indicates a defective oscillator circuit.

- 3) **Testing of selection and receiving solenoid:** To verify that the two solenoids are operating normally. Correct operation is indicated by the sound of each solenoid operating for 0.5sec for four cycles.

(Normal)

[1234], [756, 774]

(4th Photo Fail)

[123x], [756, 774]

(1st Oscillator circuit fail)

[1234], [999, 774]

3 – Collect Solenoid Testing

To ensure coin acceptance is normal, the collect Solenoid should activate on each operation.

COLLECT SOLENOID

01 – Protect 10c

When Activated phone will NOT accept consecutive 10 cent Pieces. If separated by other denominations multiple 10 c pieces will be accepted.

(*Default = ON*)

Protect 10c: ON

02 – PTT Local

50Hz or 12KHz Local PTT Calls can be assigned a Time limit of between 30 Secs and 20 Minutes per Unit Price.

Range 0.5m – 20m (*Default = DISABLE*)

PTT LOCAL: DISAB

Inserting additional coins to the 'Unit Price' value can extend this limit.

NOTE: 1800 calls are Timed as above BUT can NOT be extended by adding coins.

Free 1800 Calls WILL cut off after Time limit has lapsed.

If a second PTT meter pulse is detected before the time limit expires, the timer is disabled and operation returns to normal PTT metering.

03 – Reserved

04 – Free Call

It is possible to program four telephone numbers for the purpose of having no-charge calls.

Programmed numbers can have a Maximum of 10 digits

Free calls are achieved by dialling the programmed free phone number.
Each free phone number must not be more than ten digits long.

Example: Dial **9 9 3 4 5 6 7 8**

Then press the **#** key to save.

If a free phone number is to be deleted, key in any number until the LCD is blank, then press the **#** key to save.

After each free number has been programmed, press the **# key to save, then Continue until completed.**

Australian phones have “000” & “106” permanently programmed as a “Free Call” into memory. There are no time restrictions on Emergency calls.

05 – Blocked Numbers

It is possible to block four prefixes or telephone numbers to a Maximum of 10 digits.

If the prefix of the dialled number is the same as the programmed blocked number the call will not be allowed.

Example: Press **0** **8** and hit the **#** key to save.

B1: 08

After this, all calls to numbers with the prefix “08” will be blocked. (e.g. 08 8123 4567)

If a blocked number is to be deleted, key in any number until the LCD is blank, then press the **#** key to save. (**Refer Program Number 20 also**)

After each number has been programmed, press the **# key to save, then continue unit completed.**

06 – PTT meter pulses

Number of 50Hz & 12KHz Meter Pulses detected from the PTT
This counter is returned to zero when the coin tin contents are cleared.

SPM = 245

07 – Password Mode

A password of eight digits is required, and can be programmed for a “Owner’s Password” and a different password is for “Programming Access”.
The “Owner’s Password” can be used for coin tin contents checking and coinless calls.

Example: Dial **1** **2** **3** **4** **5** **6** **7** **8**

OWNER: _

Then press the **#** key to save.

The Program password can be changed from default. (*Default = 00807050*)

Example: Dial **1** **1** **1** **1** **1** **1** **1** **1**

PROG: 00807050

Then press the **#** key to save.

IF THE PROGRAM PASSWORD IS CHANGED FROM THE DEFAULT, MAKE A PERMANENT NOTE OF THE NEW PASSWORD FOR FUTURE REFERENCE.
If a password is to be deleted, key in any number until the LCD is blank, then press the **#** key to save.

After each password has been programmed, press the **# key to save, then Continue until completed.**

08 – PTT or PABX Selection

This function is set to suit the type of telephone line the telephone is connected to.

When phone is connected to a PTT line. (*Default = PTT*)

◆ LINE: PTT LINE

When phone is connected to a PABX line.

◆ LINE: BEHIND PBX

In PABX mode a prefix with a maximum of two digits has to be programmed for selecting a outside line. Example: Press 0 as prefix for outside line selection, save with # key.

This programmed prefix will be automatically dialled when customer lifts the handpiece. After the line type has been programmed, press the # key to save.

09 – Reserved

10 – Long Distance Call Control

Local call enable (STD & IDD not allowed)

◆ ENABLE: LOCAL

Local and Long Distance call enable (IDD not Allowed)

◆ ENABLE: STD

Local, Long Distance and International Call Enable(Full access)

◆ ENABLE: IDD

(*Default = IDD Enable*)

Access area displayed on entering this program is the current allowed Access

After calling type has been programmed, press the # key to save.

11 – Incoming Call Programming

This option is provided to limit the duration of incoming calls, Maximum 99 mins

Duration of ‘Free’ incoming call is unlimited.

◆ INCOMING: FREE

Duration of ‘Free’ incoming call is limited. (*Default = 10 Mins*)

◆ INCOMING:10min

Incoming calls are NOT allowed.

◆ INCOMING: 0min

If a modem is fitted to the phone the number of rings before auto answer is set via an internal strap. Timed Incoming calls can be extended by depositing coins (as per LOC01 in program 21). A warning tone will sound 15secs before cut off so that more coins can be added.

After the time duration has been programmed, press the # key to save.

12 – Metering Type Selection

Self Tariffing: Polarity reversal

◆ REVERSE

Self Tariffing: Polarity reversal and TALK button

◆ REVERSE+TALK

Self Tariffing: 12/16KHz

◆ SELF 12/16KHz

Self Tariffing: 50Hz

◆ SELF 50Hz

PTT Metering: 12/16KHz (*Default = PTT 12/16KHz*)

◆ PTT 12/16KHz

PTT Metering: 50Hz

◆ PTT 50Hz

Self Tariffing: Auto Detection and TALK button

◆ AUTO+TALK

Self Tariffing: Press TALK Button to talk.

◆ TALK BUTTON

Self Tariffing: Call cost is calculated by the payphone using pre-programmed tariff tables, which can allow for the number dialed, time of day and day of week. Charging is done in multiples of the unit fee on a timed basis.

00 : 59 \$0.00

PTT Metering: A 50Hz or 12KHz signal is sent from the PTT, for all calls one signal is sent on answer, on STD & IDD calls additional signals are sent at a time spacing which depends on the the number dialled and therefore the cost of the call. One Unit fee is collected for each meter pulse detected.

Number Dialled \$0.00

After metering type has been programmed, press the # key to save.

NOTE: ALSO SEE “PROGRAM 02”

13 – Reserved**14 – Coin Accumulation**

This function displays the total value of coins collected since the Payphone was installed, or since the phone has been reinitialised.

\$\$\$= \$1256.00

Note: This total is NOT reset when the coin tin is emptied.

15 – Coin Validation

The coin validator accepts only genuine coins into the escrow area pending collection. Deposited coins are subject to electrical measurements of three parameters: thickness, diameter and alloy content. A maximum of six different denomination coins can be accepted. Acceptance rates are based on statistical sampling of coins from a sample of each coin.

The coin validator is capable of accepting six different coin denominations and can be readily programmed for acceptance or rejection.

\$0.10 1st coin accepted

◆ (1) \$0.10 ◆ YES ◆

To program coin criteria, insert multiple coins (Minimum 10) and save by pressing **#** key.

The example shown is for a 10c piece after learning from samples

611 – 616, 751 - 756

Use at least 10 different coins of each denomination; insert one coin at a time to get a more accurate validation. Press the **# key to save, continue until complete.**

**Coin parameters
should NOT be adjusted in
the field.**

1 – In sampling mode

To program coin criteria by means of sampling, it is recommended that each coin be inserted at least five times, the greater the number of samples of each coin denomination, the greater the accuracy of coin acceptance.

1ST= 613, 2ND = 753

Coin criteria will be shown on the LCD display after each coin sampling is saved, then it will change to edit mode.

613 – 614, 752 - 754

p1 p2 p3 p4

2 – In edit mode

Coins are either accepted or rejected on these criteria. The criteria range can be manually adjusted by the following method.

To adjust criteria:

Press the **4** key to decrease the value of p1, press the **1** key to increase the value of p1

Press the **5** key to decrease the value of p2, press the **2** key to increase the value of p2

Press the **6** key to decrease the value of p3, press the **3** key to increase the value of p3

Press the **0** key to decrease the value of p4, press the **8** key to increase the value of p4

Recommended coin criteria adjustment.

To allow for the variations in coin properties it is recommended that the selection parameters be widened for each coin. For Example:

613 – 614, 752 - 754

(Sampled coins parameters)

Press the **4** key to decrease the p1 value by 3-5 points

609 – 614, 752 - 754

Press the **2** key to increase the p2 value by 3-5 points

609 – 618, 752 - 754

Press the **6** key to decrease the p3 value by 3-5 points

609 – 618, 748 - 754

Press the **8** key to increase the p4 value by 3-5 points

609 – 618, 748 - 758

After each coin parameter has been adjusted, press the **#** key to save.

**Coin parameters
should NOT be adjusted in
the field.**

16 – Clock Setting

| | |
|--|-----------------|
| Year setting | ◆ YEAR-----2003 |
| Month Setting | ◆ MONTH-----03 |
| Day Setting | ◆ DATE-----08 |
| Hour Setting | ◆ HOUR-----13 |
| Minute Setting | ◆ MINUTE-----45 |
| Second Setting | ◆ SECOND-----30 |
| Weekday Setting (Sunday = 0, Monday = 1, etc.) | ◆ WEEKDAY-----2 |

After the clock has been programmed, press the  key to save.

17 – Voice Prompt Setting

The voice prompt function can be turned on or off.

| | |
|---|-------------------|
| Voice prompt function is ON | ◆ VOICE: TURN ON |
| Voice prompt function is OFF (<i>Default = Voice OFF</i>) | ◆ VOICE: TURN OFF |

After voice prompt setting has been selected, press the  key to save.

18 – Coin Tin Capacity Setting

Setting a coin capacity of 300 pieces (*Default = Disable*)
(*Range Disable, 100 – 2000 pieces.*)

◆ CASHBOX: 300pcs

If this is active and the coin tin contents reach the programmed number of pieces, the phone will stop working and display an error message. “ COIN TIN FULL “

After Coin tin capacity has been programmed, press the  key to save.

19 – Unit Price Setting

1 / Self Tariffing Mode:

Defines the charge rate per unit that is programmed in the tariff band.

2 / PTT Metering Mode:

This is the unit price charged for each meter pulse that is detected.

1 UNIT = \$0.50 

Range \$ 0.10c - \$25.00 (Default = 0.50c)

ALSO SEE PROGRAM 22

After the unit price has been programmed, press the  key to save.

20 – Assign Tariff Bands

It is recommended that the tariff bands be edited via the “Remote Management System” software and PC modem (CX920A with internal modem only)

If keypad editing is to be done the following should be considered.

You MUST edit prefixes with the lower number of digits BEFORE a prefix with a higher number of digits. If this rule is not adhered to the result will be an incorrect tariff rate.

Example:

1 = local 01

12 = local 02

123 = local 03

.....

1234567 = local 07

Programming:

“1” should be edited first

“12” should be edited next

“123” should be edited next

.....

“1234567” should be edited last.

Warning: If you were to edit “1234567 = local 07” first, and then edit “123 = local 03” after that, then any numbers dialled with the prefix 123 up to 123xxxx will be given a local 03 rate, including the number 1234567, even through it was programmed as local 07!

If the tariffs are edited via the keypad-programming mode, inaccuracies may occur in the ‘Remote Management System’ database if applicable.

**Tariff parameters
should NOT be adjusted
by inexperienced personnel.**

1 – Prefix Range

Prefixes or numbers can be assigned to a Maximum length of 7 digits, NOT including any preceding zeros.

Local: xxxxxxx (7 digits programming)
 STD: 0xxxxxxx (8 digits programming)
 IDD: 00xxxxxxx(9 digits programming)

To display current tariff band assigned to a Prefix or Number.

Key in the prefix number, and then press the **#** to display. Example: **1** **#**

2 – Operation

Enter prefix codes.

ENTER PREFIX:

Assign the Local tariff bands

123 : LOC 01

Assign the STD tariff bands

0123 : STD 01

Assign the IDD tariff bands

00123 : IDD 01

- **FREE** = number dialled is free of charge
- **BLOCK** = Access to this number is NOT allowed
- **LOCAL01 – LOCAL16** = number dialled is charged at that local tariff band
- **STD01 – STD16** = number dialled is charged at that long distance tariff band
- **IDD01 – IDD15** = number dialled is charged at that international tariff band

After each Tariff Band is assigned, press the **#** key. This saves the information and allows you to enter the next prefix.

See Program Area Number 24 – This can be used to limit the Tariff Band Range.

IMPORTANT: Keep a written record of information that is programmed on each prefix and tariff band for future reference.

Refer: Appendix ‘A’ at back of this Manual

(Default = 19xx Blocked, 1800 Free, 12455 Free, 1225 Free, 1223 Free)
 These Defaults can be changed if required.

21 – Tariff Band Programming

LOCAL Tariff Band programming:

Local tariff band 01 for 'normal' rate

◆ L01n : 1u ◆ 60s ◆

Local tariff band 01 for 'discount' rate

◆ L01d : 1u ◆ 60s ◆

Local tariff band 01 for 'economy' rate

◆ L01e : 1u ◆ 120s ◆

- 1 3 Keys are used to select the tariff band
- 2 4 Keys are used to adjust the number of charge units from 1 to 200 units
- 3 5 Keys are used to adjust the conversation time from 0.1 second to 999
seconds.

NOTE: LOC01 – Has an UNLIMITED conversation time option. (*Default = 1u, 60 secs*)

LONG DISTANCE Tariff Band programming:

STD tariff band 01 for 'normal' rate

◆ S01n : 1u ◆ 20s ◆

STD tariff band 01 for 'discount' rate

◆ S01d : 1u ◆ 30s ◆

STD tariff band 01 for 'economy' rate

◆ S01e : 1u ◆ 40s ◆

- 1 4 Keys are used to select the tariff band
- 2 5 Keys are used to adjust the number of charge units from 1 to 200 units
- 3 6 Keys are used to adjust the conversation time from 0.1 second to 999
seconds. (120 Seconds Max for 'discount' and 'economy' bands)

(*Default = 1u, 20 secs*)

21 – Tariff Band Programming - Continued

INTERNATIONAL Tariff Band programming:

IDD tariff band 01 for 'normal' rate

◆ I 01n : 1u ◆ 5s ◆

IDD tariff band 01 for 'discount' rate

◆ I 01d : 1u ◆ 7s ◆

IDD tariff band 01 for 'economy' rate

◆ I 01e : 1u ◆ 10s ◆

- 1 4 Keys are used to select the tariff band
- 2 5 Keys are used to adjust the number of charge units from 1 to 200 units
- 3 6 Keys are used to adjust the conversation time from 0.1 second to 120
seconds.

After each Tariff Band has been programmed, press the # key. This saves the information and allows you to enter the next prefix.

(Default = 1u, 5 secs)

See Program Area Number 24 – This can be used to limit the Tariff Band Range.

IMPORTANT: Keep a written record of information that is programmed on each prefix and tariff band for future reference.

Refer: Appendix 'A' at back of this Manual

**Tariff parameters
should NOT be adjusted
by inexperienced personnel.**

22 – Minimum Insertion

The minimum insertion is the amount of money that **MUST** be inserted before a chargeable call can be attempted, this is independent of any programmed charge rate or unit fee.

The Local call minimum is the amount displayed at 'welcome' on lifting the receiver.

Local call minimum insertion (*Default = 0.50c*)

◆ LOC MIN.= \$0.50 ◆

STD call minimum insertion (*Default = 0.50c*)

◆ STD MIN.= \$0.50 ◆

IDD call minimum insertion (*Default = 0.50c*)

◆ IDD MIN.= \$0.50 ◆

1

4

Keys are used to select the call type.

3

6

Keys are used to adjust the minimum charge amount.

Maximum rate = \$99.90

ALSO SEE PROGRAM 19

23 – Service Fee

The service fee will charge the user a once only charge when the called party answers.

This fee is active on self-tariffing calls ONLY. Fee range to a maximum of \$25.00

Local call service fee (*Default = 0.00c All*)

◆ LOC SER = \$0.10 ◆

STD call service fee

◆ STD SER = \$0.10 ◆

IDD call service fee

◆ IDD SER = \$0.10 ◆

1

4

Keys are used to select the call type.

3

6

Keys are used to adjust service fee amount.

24 – Tariff Band Limit

The CX-920A has Sixteen (16) Local and STD bands available and Fifteen (15) IDD bands available. Access to these can be LIMITED by this function.

Local Band Range Limit

◆LOC:LOC1-LOC03◆

STD Band Range Limit

◆STD:STD1-STD03◆

IDD Band Range Limit

◆IDD:IDD1-IDD03◆

1 4 Keys are used to select the band.

3 6 Keys are used to adjust the maximum accessible band.

*The example shown above LIMITS all bands to a maximum of three.
(Default = Local01-03, Std01-03 & IDD01-06)*

**Tariff parameters
should NOT be adjusted
by inexperienced personnel.**

Call Operation Instructions

Call Operation

Lift the handpiece and listen for dial tone

INSERT COINS

Insert coins to the Minimum value required

MINIMUM \$0.50

Dial phone number

3 2 3 4 5 2 2 5

\$0.50

32345225 \$0.50

After the called party answers the call, the display will show any credit remaining.

Called Party Answers

Line Polarity Reversal

When the called party answers, the telephone line polarities are reversed by equipment at the local telephone exchange. This is detected by the CX-920A, causing the coins to be collected and conversation can then take place.

12/16KHz or 50Hz

When the called party answers, a 12KHz or 50Hz signal is sent by equipment at the local telephone exchange. This is detected by the CX-920A, causing the coins to be collected and conversation can then take place.

Talk Button

When the called party answers, push the  button causing the coins to be collected and conversation can then take place.

Auto & Talk Button

When the called party answers, The CX-920A will attempt to detect this and automatically collect the coins and start call timing, if automatic detection is not successful pressing

the  button will cause the coins to be collected and conversation can then take place.

Self Tariffing

When the called party answers, the displayed credit and timer decreases by the amount programmed into the applicable tariff. Call cost is calculated by the payphone using pre-programmed tariff tables, which can allow for the number dialed, time of day and day of week. Charging is done in multiples of the unit fee on a timed basis.

| | |
|---------|--------|
| 00 : 59 | \$0.00 |
|---------|--------|

| | |
|---------|--------|
| 00 : 30 | \$0.00 |
|---------|--------|

During the conversation, the user can add further coins if required to extend the conversation time. A warning tone sounds 15sec before a call is to be cut off, so that additional coins may be added.

At the end of the conversation, when the handpiece is returned to the hook switch, any coins remaining in the escrow will be returned.

PTT Metering

When the called party answers, the displayed credit decreases by the amount programmed as the 'unit fee'.

A 50Hz or 12KHz signal is sent from the PTT on all calls, for local calls one signal is sent on answer, on STD & IDD calls multiple signals are sent at a time spacing which depends on the the number dialed and therefore the cost of the call. One Unit fee is collected for each meter pulse detected.

| | |
|-----------|--------|
| No dialed | \$0.00 |
|-----------|--------|

During the conversation, the user can add further coins if required to extend the conversation time. On multimetering calls a warning tone sounds 10 secs before a call is to be cut off, so that additional coins may be added.

At the end of the conversation, when the handpiece is returned to the hook switch, any coins remaining in the escrow will be returned.

New Call or Follow On

The 'NEW CALL' button allows the use of any remaining credit after a call is completed.

DO NOT HANG UP

Press the 'New Call' or 'Follow On' button



| | |
|--|--------|
| | \$2.50 |
|--|--------|

Dial the new Phone Number



| | |
|----------|--------|
| 32345226 | \$2.50 |
|----------|--------|

Check the Display to ensure that there is sufficient credit remaining to cover the minimum call fee, more coins may be added if required.

| | |
|---------|--------|
| 00 : 59 | \$2.00 |
|---------|--------|

Redial

When the called party is busy, this allows the number to be redialled without reinserting coins.

DO NOT HANG UP

Listen for busy tone

32345226 \$0.50

Press the **Redial** button, and the last number will be redialled automatically.

32345226 \$0.50

Volume

If the payphone is located in a noisy environment, the Volume button can be used to increase the volume in the handpiece.

Two volume levels are possible, each time the **Vol / Talk** button is pressed, the level will change.

Owners Password Mode

In the owner's password mode, the owner is able to check the current contents of the coin tin and also has the ability to make calls without coins.

Lift the handpiece and listen for dial tone

Key in the password *** 1 2 3 4 5 6 7 8** (Example Only)

The display will then show the number of coins and the total value of coins that should be in the coin tin.

100pcs \$50.40

The owner then can make a call, which does not require coins.

When the handpiece is returned to the hookswitch the payphone returns to normal operation. This procedure is required for each call of this type.

If dialling is not commenced within 15 seconds the phone returns to normal.

Coin Tin Emptying

Lift the handpiece

INSERT COINS

Remove the coin tin, the display will show the number of coins and the total value of coins that should be in the coin tin.

100pcs \$50.40

To reset the coin counter to zero when the coin tin is replaced, you have to wait for FIVE seconds or more before replacing the coin tin.

If you wish to reset to zero then press the  button.

CLEAR BOX (#) ?

Note: If the coin tin is removed for less than five seconds, the payphone will enter the “Programming Mode”.

Maintenance

An authorised service agent should carry out cleaning of the coin runway, whenever the coin runway becomes dirty. The rate of dirt accumulation will obviously depend on the operating conditions, including the state of the coins being inserted.

As a general rule, cleaning should be done at least every 20,000 coins, or six months, whichever is sooner.

Failure to clean the acceptor may result in degradation of coin acceptance performance and eventually to coins stalling in the acceptor. For problem cleaning, use cloth dampened with water and mild soap, Soft cotton swabs are ideal for getting into the tighter area of the acceptor.

CAUTION:

DO NOT USE SOLVENTS, STEEL WOOL, SCOURING PADS OR METAL BRISTLE BRUSH, DO NOT SPRAY WITH ANY TYPE OF LUBRICANT

APPENDIX 'A'

CX920A Coin Payphone

Local Call Prefix's DEFAULT (Self Tariffing Only)

| Prefix | Default Rate | Changed Rate |
|--------|------------------|--------------|
| 100 | Local-01 | |
| 101 | Local-01 | |
| 102 | Local-01 | |
| 103 | Local-01 | |
| 104 | Local-01 | |
| 105 | Local-01 | |
| 106 | Free (untimed) | |
| 107 | Local-01 | |
| 108 | Local-01 | |
| 109 | Local-01 | |
| 11 | Local-01 | |
| 120 | Local-01 | |
| 121 | Local-01 | |
| 123 | Local-01 | |
| 125 | Local-01 | |
| 126 | Local-01 | |
| 127 | Local-01 | |
| 128 | Local-01 | |
| 129 | Local-01 | |
| 13 | Local-01 | |
| 14 | Local-01 | |
| 15 | Local-01 | |
| 16 | Local-01 | |
| 17 | Local-01 | |
| 1800 | Free | |
| 181 | Local-01 | |
| 182 | Local-01 | |
| 183 | Local-01 | |
| 184 | Local-01 | |
| 185 | Local-01 | |
| 186 | Local-01 | |
| 187 | Local-01 | |
| 188 | Local-01 | |
| 189 | Local-01 | |
| 19 | Barred | |
| 2 | Local-01 | |
| 3 | Local-01 | |
| 4 | Local-01 | |
| 5 | Local-01 | |
| 6 | Local-01 | |
| 7 | Local-01 | |
| 8 | Local-01 | |
| 9 | Local-01 | |

Local 01 = 1unit per 60 sec
 Local 02 = 1unit per 60 sec
 Local 03 = 1unit per 60 sec

STD Call Prefix's DEFAULT (Self Tariffing Only)

| Prefix | Default Rate | Changed Rate |
|--------|--------------|--------------|
| 0-1 | STD-01 | |
| 0-2 | STD-01 | |
| 0-3 | STD-01 | |
| 0-4 | STD-01 | |
| 0-5 | STD-01 | |
| 0-6 | STD-01 | |
| 0-7 | STD-01 | |
| 0-8 | STD-01 | |
| 0-9 | STD-01 | |

STD-01 = 1unit per 20 sec
 STD-02 = 1unit per 20 sec
 STD-03 = 1unit per 20 sec

IDD Call Prefix's DEFAULT (Self Tariffing Only)

| Prefix | Default Rate | Changed Rate |
|--------|------------------|--------------|
| 00-1 | IDD-01 | |
| 00-2 | IDD-01 | |
| 00-3 | IDD-01 | |
| 00-4 | IDD-01 | |
| 00-5 | IDD-01 | |
| 00-6 | IDD-01 | |
| 00-7 | IDD-01 | |
| 00-8 | IDD-01 | |
| 00-9 | IDD-01 | |
| 00-0 | Free (untimed) | |

IDD-01 = 1unit per 5 sec
 IDD-02 = 1unit per 5 sec
 IDD-03 = 1unit per 5 sec

Warranty

The CX920A Coin Payphone carries a 12-month return to base warranty from the date of purchase against faulty workmanship or materials.

Tee-Tee-S Pty Ltd, at its sole discretion shall replace, repair, or adjust any part of the equipment which fails as a result of faulty manufacturing or assembly as soon as practicable after notification by the owner.

Cost of transport of telephone both to repair agent and return are to be met by the claimant.

Exclusions to the Warranty

- Theft of equipment and/or associated monies
- Damage from misuse, vandalism or negligence
- Damage, malfunction or loss because of incorrect installation / programming
- Clearance of Coin Blockages & Cleaning of Coin Runway
- Normal wear and tear
- Malfunction or damage caused by lightning, electro-static interference, electromagnetic interference, over voltage or over current surges however caused
- Malfunction or damage caused by liquid ingress
- Malfunction or damage caused by excessive dust/dirt ingress
- Repairs or adjustments other than those made by authorised service agents.

This warranty is in addition to any mandatory conditions, warranties and guarantee under any Commonwealth or State Acts

Warning: This Payphone contains a Lithium battery

There is a danger of explosion if this lithium battery is incorrectly replaced.

Replace **ONLY** with the same or equivalent type recommended by the manufacturer. Dispose of used batteries, according to manufacturer's instructions.